

# SONY



## MINIDISC MANUAL

V3.0E



Introduction .....	1
<b>1. The MiniDisc System</b>	
1.1. The Features .....	2
1.2. What it is and How it Works .....	3
1.3. Serial Copy Management System .....	8
1.4. Additional Features of the Premastered MD .....	8
<b>2. The production process of the premastered MD</b>	
2.1. MD Production .....	9
2.2. MD Components .....	10
<b>3. Input components specification</b>	
3.1. Sound Carrier Specifications .....	12
3.2. Additional TOC Data / Character Information .....	17
3.3. Label-, Artwork- and Print Films .....	19
3.4. MiniDisc Logo .....	23
<b>4. Sony DADC Austria AG</b>	
4.1. The Company .....	25
<b>Appendix</b>	
Form Sheets	



*The quick random access of Compact Disc players has become a necessity for music lovers. The high quality of digital sound is now the norm. The future of personal audio must meet the above criteria and more.*

*That's why Sony has created the MiniDisc, a revolutionary evolution in the field of digital audio based on an advanced miniature optical disc.*

*The MD offers consumers the quick random access, durability and high sound quality of optical media, as well as superb compactness, shock-resistant portability and recordability. In short, the MD format has been created to meet the needs of personal music entertainment in the future.*

*Based on a dazzling array of new technologies, the MiniDisc offers a new lifestyle in personal audio enjoyment.*

## 1. The MiniDisc System

### 1.1. The Features

*With the MiniDisc, Sony has created a revolutionary optical disc. It offers all the features that music fans have been waiting for.*



#### **Quick Random Access**

The MiniDisc offers quick random access to the music selection or phrase of your choice; something only a disc is capable of.



#### **Total Durability**

The MiniDisc can never stretch, break or tangle like cassette tapes. Since the free floating optical pick-up never touches the surface, scratches are impossible.



#### **Superb Compactness**

The MiniDisc itself is only approximately 64 mm in diameter, and the cartridge is 72 x 68 x 5 mm. And because the MiniDisc is smaller, so is the MiniDisc player.



#### **Shock-Resistant Portability**

The MiniDisc is resistant against shocks and vibrations. New technology, using an advanced semiconductor memory, provides almost total shock resistance so there is no skipping and jitter even while jogging or driving.



#### **Easy to Handle**

The disc is protected in a cartridge. It is easy to handle and the ideal sound carrier for mobile use.



#### **Unsurpassed Digital Sound**

The MiniDisc is based on the same noiseless and distortion-free digital recording technology as the compact disc. So whether you are recording your own or listening to prerecorded music, you have the optimum in audio quality wherever you go.



#### **Recordable Disc**

4 Track Recording: "A disc which records" is every music fan's dream come true. The MiniDisc offers about 74 minutes digital recording on one tiny disc.

## 1.2. What it is and How it Works

Two Kinds of MiniDiscs are Available:

### Premastered MiniDiscs for Music Software

Premastered MiniDiscs are used most commonly for music and are sold in record stores just the same as compact cassettes and CDs are.

MiniDiscs, just like CDs, are manufactured in large volumes by high-speed injection molders, and the music signals are recorded during replication in the form of pits.

Forget the times when you would worry about cassette tapes becoming worn out or wrinkled.

Moreover, the discs are encased in a cartridge, so there is no worry about their being scratched.

The design of the premastered MiniDisc cartridges

is special. Prerecorded music packages require a label, featuring the artist's picture or other information – for it is the artwork that most often captures the buyer's eye. Therefore the top face of the cartridge is left completely free for the label. A window for the laser beam to read the disc is only necessary on the bottom face.

### Recordable MiniDiscs

Magneto-optical (MO) technology forms the heart of the recordable MiniDisc technology. Not only are MO discs durable enough to withstand being rerecorded about 1 million times, they also have a life expectancy approaching that of CDs.

When recording the MO discs, a laser beam must be focused onto the magnetic layer from behind while a magnetic field is applied to the front. For this reason, the cartridges for recordable MiniDiscs have a read/write window on both sides.

### MiniDisc Pick-up Technology

Optical Pick-up of MD Player:

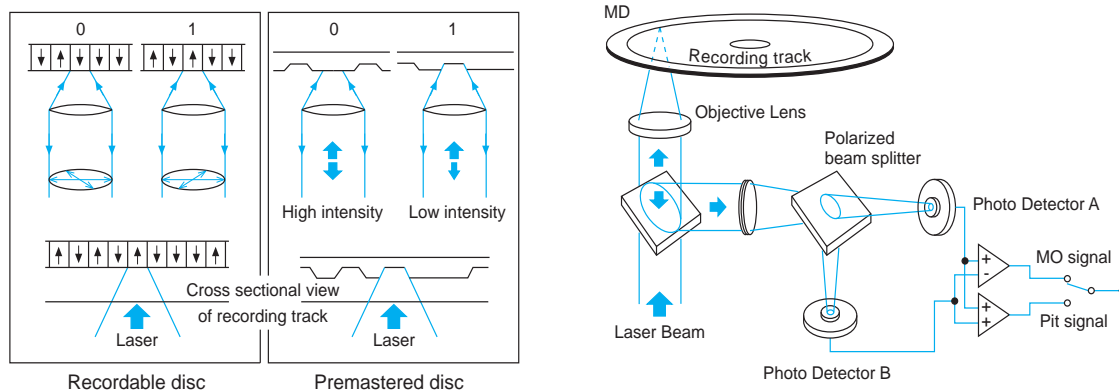

The optical pick-up developed for the MD system has the remarkable ability to read both recordable and premastered MiniDiscs. For recordable discs, the pick-up detects the magnetic structure along the track. For premastered optical discs, it detects the geometric structure along the track. The MD system is based on the design of the standard CD pick-up with the addition of a MO signal readout analyzer and two photodiodes. During playback of recordable discs a 0.5mW laser

is focused onto the magnetic layer. The magnetic signal on the disc affects the polarization of the reflected beam. The direction of polarization is converted into light intensity by the MO signal readout analyzer. Depending on the direction of polarization one of the two photodiodes will detect more light. The electrical signals from the photodiodes are subtracted and depending on whether the difference is positive or negative, a "1" or "0" signal is read.

## What it is and How it Works

The same 0.5mW laser is used for the playback of premastered optical discs. The amount of light reflected depends on whether or not a pit exists on the surface of the disc. If there is no pit, a high proportion of the light is reflected back through the beam splitter and analyzer into the photodiodes. If a pit does exist, some of the light is diffracted and less light reaches the photodiodes. The electrical signals from the photodiodes are added up in this case and depending on the sum, a "1" or "0" is read.

### Overwrite Technology

In order to meet the requirements of a compact, lightweight, recordable audio system for personal use, the MD system employs a newly developed Sony magneto-optical (MO) disc that utilizes magnetic field modulation with direct "overwrite" capability. With MO disc technology, the recording of data requires the use of a laser and a polarizing magnetic field. When the magnetic

layer in the disc is heated by the laser to a temperature above the Curie point (approximately 200° C), it temporarily loses its coercive force. As the disc rotates and the irradiated domain returns to normal temperature, its magnetic orientation is determined by an externally applied magnetic field. Polarities of "N" and "S" can thus be recorded, corresponding to digital data "1" and "0".

Unlike conventional MO rewrite mechanisms, the "Sony MD overwrite system" positions a magnetic head directly across from the laser source on the opposite side of the disc. A magnetic field corresponding to the input signal is generated over the laser spot. The rotation of the disc then displaces the area to be recorded, allowing the temperature at the spot to drop back below the Curie point. At that point, the domain takes on the polarity of the applied magnetic field regardless of the polarity that previously existed.

Overwrite Mechanism

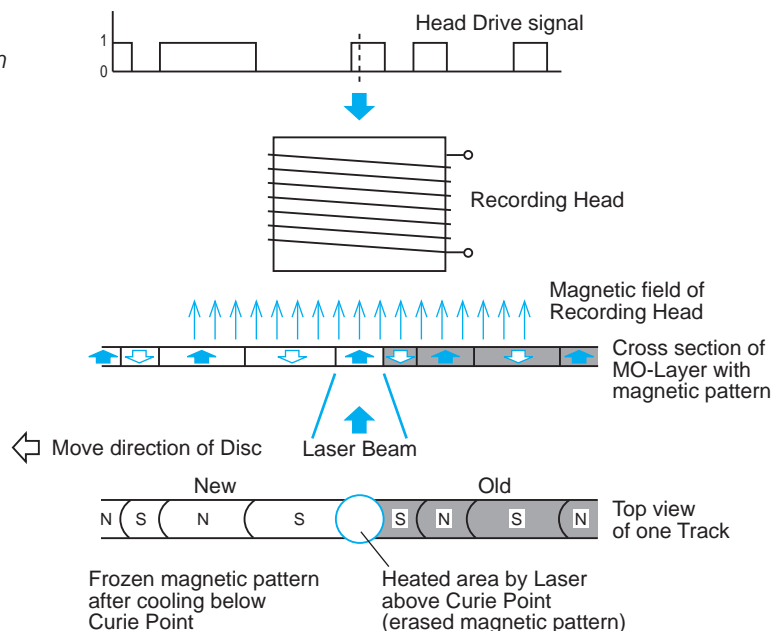

## Quick Random Access

### *Reprogramming the Order of Music*

#### 1. Ordinary Method:

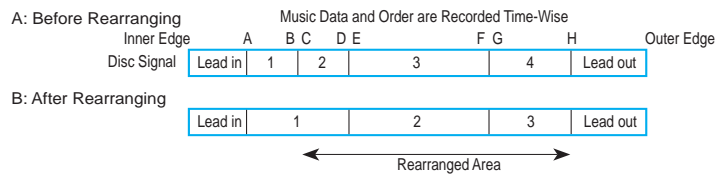

#### 2. MiniDisc:

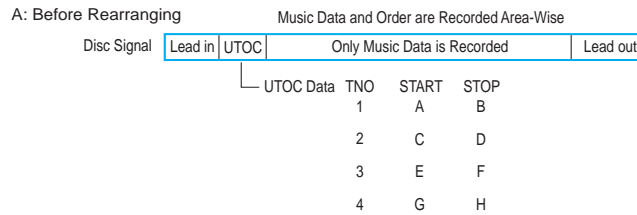

B: After Rearranging (No Change of Music Data)

Connecting two Tracks:

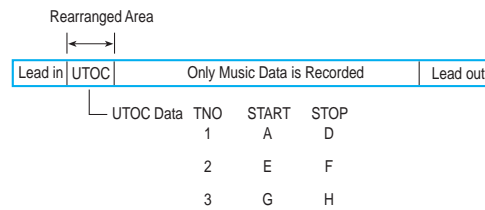

Additional Reprogramming the Order:

TNO	START	STOP
1	A	D
2	G	H
3	E	F

The ease of quick random access was made possible by the development of the Compact Disc (CD). The CD instantaneously provides random access to the beginning of any desired music selection. After using a CD player, the time to reach the music selection of your choice with cassette tape players seems extremely cumbersome.

The MiniDisc provides the same high-speed random access for recordable discs as well as for premastered discs. In addition, the recordable MiniDisc has a circumferential microgroove or "pre-groove", which is formed when the polycarbonate substrate is injection molded. This pre-groove is the basis for the tracking servo and spindle servo operation during recording or playback.

Address information is recorded at intervals of 13.3 milliseconds using a technology that places infinitesimal zigzags on this pre-groove. Therefore, the disc has all the addresses already notched along the groove even with no recording. The result is a

stable and quick random access, as well as a variety of optional features, including programming of the playback sequence e.g.: rearranging the sequence of the titles recorded on the MD without rerecording of the music information in a matter of seconds.

This is possible because of the "User TOC Area", located around the inner edge of the microgroove, which only contains the order of the music. This system is similar to the "directory management system" of floppy discs. In other words, starting and ending addresses for all music tracks recorded on the disc are stored in this area, enabling easy programming just by rewriting the addresses. This supports also other features: it is possible to erase a track out of a sequence and during playback no gap in the remaining music will be heard. The erased segment is allocated to the free space – it is possible to record a piece of music independent of the number of segments used.

# What it is and How it Works

## ATRAC Digital Audio Compression Technology

In order to provide approximately 74 minutes of music on the 2.5-inch MiniDisc, a digital audio compression technology called "ATRAC" (Adaptive Transform Acoustic Coding) has been newly developed. This technology compresses information down to approximately one fifth of the amount of data usually required.

In 16-bit linear encoding, currently used in the CD and DAT formats, with a sampling frequency of 44.1 kHz, the analog signal is sampled approximately once every 0.02 milliseconds. Each sample is quantized at 16-bit resolution into one of 65536 possible values. Therefore, with CD and DAT, when the analog signal is converted to digital data in real time, 16 bits of data are used every 0.02 milliseconds, regardless of the amplitude of the signal and whether or not a signal is present at all.

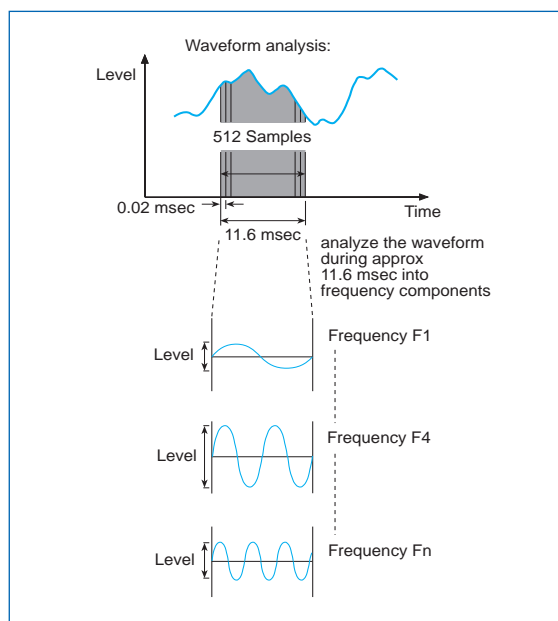

ATRAC starts with the same 16-bit digital data but analyzes segments of the data for waveform content every 11.6 msec. Based on this analysis, ATRAC extracts and encodes only those frequency components that are actually audible to the human ear. This method of encoding is far more efficient than the linear coding technique used for CD and DAT, yet sound quality remains comparable. The following underlying psychoacoustic principles are used during this conversion.

### Threshold of Hearing:

As sound level diminishes, there is a level below which the human ear cannot detect. This threshold varies with frequency. The threshold of audibility is lowest for sounds with a frequency of approximately 4kHz; that is, sounds close to this frequency are most easily detected by the ear. By analyzing the frequency components of an audio signal, it is possible to identify those components that lie below the threshold of hearing. Such components can be removed from the original signal without affecting perceived sound quality.

### Masking Effect:

If two sounds, one loud and the other soft, are produced simultaneously and they are close to one another in frequency, the softer sound becomes difficult or even impossible to hear. Therefore, when an audio signal has a high level component and a low level component at neighbouring frequencies, the latter can be removed without affecting perceived sound quality. Moreover, with increasing overall signal amplitude, it becomes possible to remove a greater number of components without audible effect.

### Psychoacoustic principles:

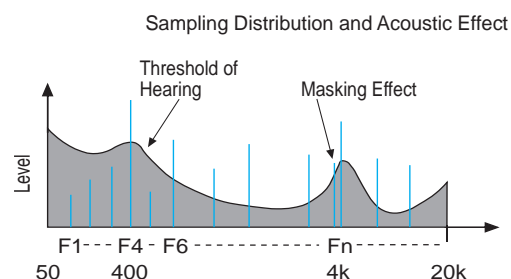

### Sampling from ATRAC and its Level

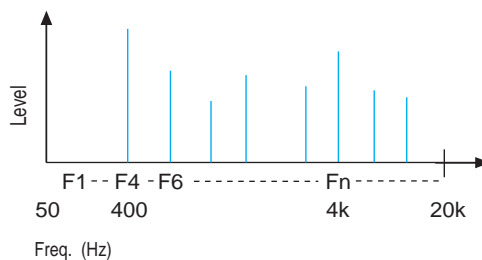



## Shock-Resistant Memory

Conventional optical pick-up systems can easily mistrack when subjected to shock or vibration. In digital audio CDs, this causes "skipping" or muting. Resistance to shock and vibration is a virtual prerequisite for true portable personal audio applications. In the MD system, Sony has solved this problem with a unique shock-resistant memory.

While the MD pick-up can read information off the disc at a rate of 1.4Mbit per second, the ATAC decoder requires a data rate of only 0.3Mbit per second for real time playback. This difference in processing speed enables the use of a readahead buffer, placed between the pick-up and the decoder. If a 4Mbit memory chip is used for the buffer, it can store up to 10 seconds of digital information. Should the pick-up be jarred out of position, the correct information continues to be supplied to the ATAC decoder from the

buffer memory. As long as the pick-up returns to the correct position within 10 seconds, the listener never experiences mistracking or muting. Since signals enter the buffer memory faster than they leave it, the buffer will eventually become full. At that point, the MD player momentarily stops reading information from the disc; it resumes reading as soon as there is again room in the memory chip.

Using a concept called sector repositioning, the MD pick-up has the ability to quickly resume reading from the correct point after being displaced. When signals are recorded on the MiniDisc (either recordable MO or premastered optical media), address information is assigned every 13.3 milliseconds. When a pick-up is shifted out of place, the MD player quickly recognizes the disruption, identifies the wrong address, and instantly returns the pick-up to the correct position.

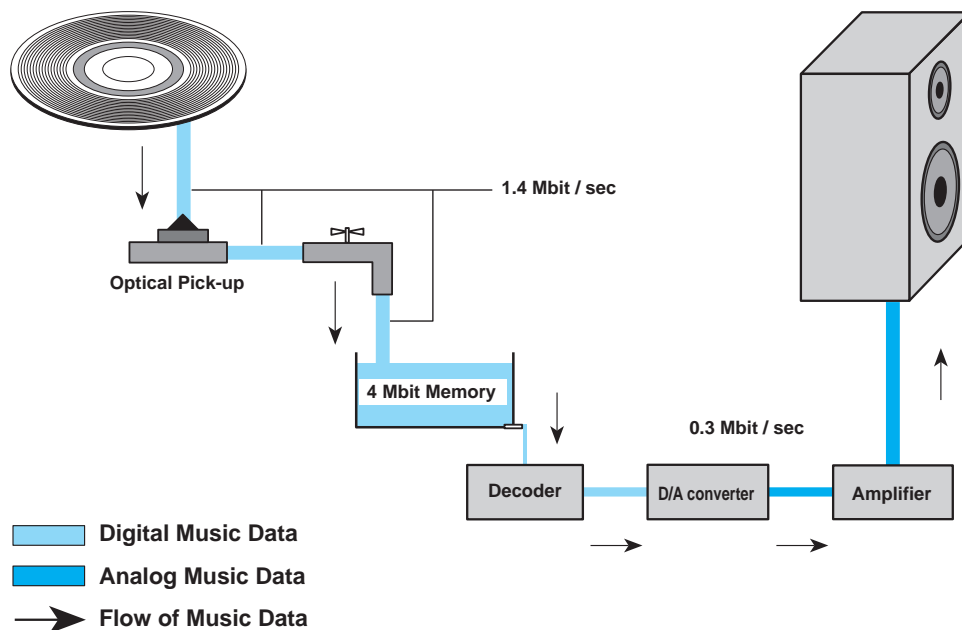

## 1.3. Serial Copy Management System (SCMS)

The MD conforms to the SCMS convention (see ISO-958 + Amendment 84 (C. O.) 126 and 126A). The Serial Copy Management System allows to make a first digital copy from digital sources. Further digital copies from protected sources are prevented, copies in the analog domain remain possible.

## 1.4. Serial Copy Management System (SCMS)

The premastered MD has following additional advantages:

- The data is stored in physical pits and is therefore never erased unless it is mechanically destroyed.
- The label area is larger than the one of the recordable MD. The entire area of one side can be used for labeling. The recordable MD has a shutter on both sides and its label is relatively small.
- The premastered MD contains valuable character information (e.g. disc & track names) which will not be transferred during copying.
- The subdata capacity of the premastered MD is bigger. So it is possible to record more character information onto the MD.

## Sony MiniDisc System Specifications

Channels:	2 (Stereo)
Frequency Response:	5 - 20.000 Hz
Dynamic Range:	105 dB
Wow- and Flutter:	Unmeasurable
Sampling Frequency:	44.1 kHz
Coding System:	ATRAC System
Modulation System:	EFM
Error Correction System:	CIRC
Disc Speed:	1.2 - 1.4 m/sec (CLV)
Record/Playback Time:	about 74 minutes
Cartridge Size:	72 x 68 x 5 mm
Disc Diameter:	64 mm

## 2. The production process of the premastered MD

### 2.1. MD Production

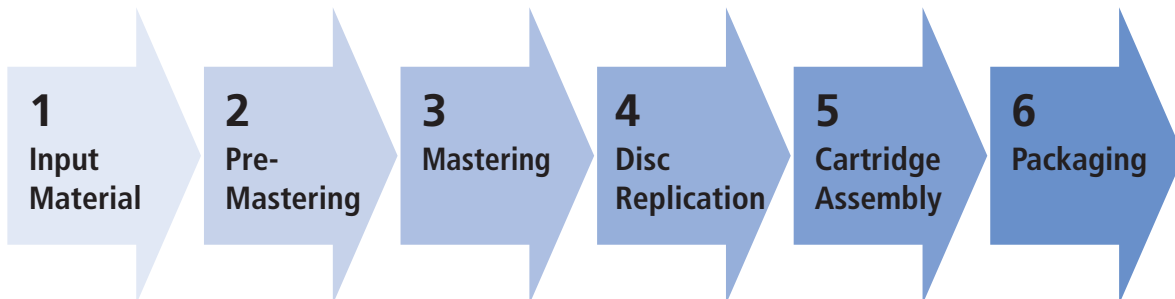

#### 1. *Input Material*

DADC requires following input components from customers:

- A MD master tape or a sound carrier as for CD production (e.g. PQ-encoded U-Matic 1630).
- Print films, as well as colour proofs, for artwork, label- and cartridge print.
- Completely filled in form sheets (sample forms 1, 2 & 3 on pages 14, 15 & 18, form sheets in appendix).

Production can be started as soon as all necessary components have arrived.

#### 2. *Premastering*

At the premastering studio the CD-Master tape is converted to a MD-Master tape. This means that the audio information is compressed by a Format Converter using the ATRAC compression technology. Also the PQ-code is converted to MD specific data and optional subdata (POS\*, disc name, track name) can be added. All information then is recorded onto a MD Master.

#### 3. *Mastering*

A nickel stamper for MD replication is produced in the same process as for CD. A glass plate is coated with a thin layer of photo lacquer. A laser spot records the data from the MD Master into the photo lacquer. The nickel negatives which are produced from the developed plate are used to replicate the MD.

#### 4. *Disc Replication*

The replication process of the MD is the same as for CD. After creating a disc by using high precision molding technology, the MD is coated with a thin layer of aluminum as reflective media, and subsequently with protective lacquer to protect it against damage. Then the coated discs are 100% quality inspected.

#### 5. *Cartridge Assembly*

As the first step in the finishing process, the cartridge is prepared with a paper label glued onto the front and other information printed in white on the back and spine. After the clamping plate has been mounted onto the MD, the MD is set into the cartridge halves and the cartridge is welded.

#### 6. *Packaging*

Packaging is done very similar to CD packaging, with a booklet and a backline card added to the MD in a special MD jewel case.

\* point of sales data.

## 2.2. MD Components

The MD consists of the following components:

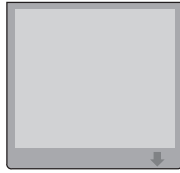

Upper Cartridge (e.g. Polycarbonate)



Label (Paper)

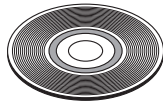

Disc (e.g. Polycarbonate)



Clamping Plate (e.g. Stainless Steel)  
Shutter Lock (e.g. POM)  
Shutter (e.g. POM)

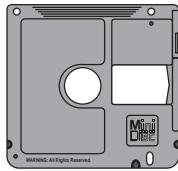

Lower Cartridge (e.g. Polycarbonate)

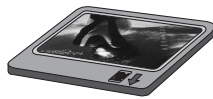

Assembled MiniDisc

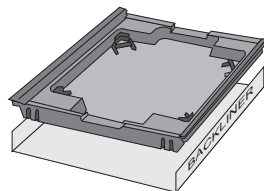

Tray (e.g. Polycarbonate)  
Backline Card (Paper)

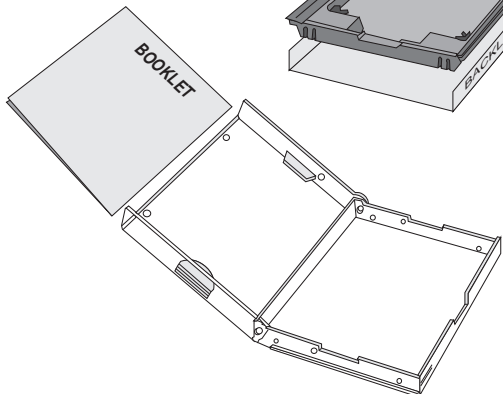

MD Jewel Case (e.g. Polycarbonate)

### 1. Upper Cartridge

The upper cartridge is made of grey plastics (e.g. polycarbonate). Its purpose is to protect the MD against mechanical damage or dust. The upper cartridge also forms the spine on which the disc ID information will be printed in white ink.

### 2. Label

The paper label is glued onto the upper cartridge.

### 3. Disc

The disc is manufactured in the same way as CDs are. It has a polycarbonate layer which contains the data. A thin layer of aluminum is used as reflective media, which is protected by a protective layer against destruction.

### 4. Clamping Plate

The clamping plate is made of magnetic stainless steel. This steel plate allows to stabilize the MD from the bottom side with a magnetic chuck. Therefore the MD does not require a hole in the upper cartridge and so almost the complete surface of the upper cartridge can be used for the label.

### 5. Shutter Lock:

It is made of plastics (e.g. POM) and locks the shutter in the close position.

### 6. Shutter:

The shutter is made of plastics (e.g. POM). It closes the opening in the lower cartridge through which the data is read and it protects the MD against dust and damage.

### 7. Lower Cartridge:

Also the lower cartridge is made of grey plastics (e.g. Polycarbonate). It contains openings for the disc-drive and the laser that reads out the data. On the backside, information like artist, titles, playing time, etc. as well as the catalogue number is printed directly on the cartridge in white ink.

### 8. MD Jewel Case:

The MD is packaged in a 3-piece Jewel Case, consisting of clear bottom and lid parts and a grey tray. It contains a booklet and a backline card similar as CD package. The MD Jewel case dimensions are 110 x 91 x 15 mm.

#### Disc:

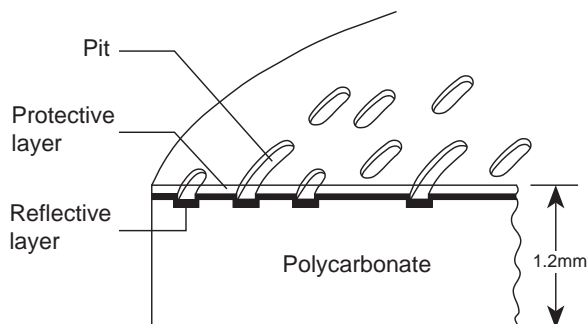

## 3.1. Sound Carrier Specifications

DADC offers all necessary facilities to prepare sound carriers for MD-production. For example PQ-encoding, digital editing for the common digital tape formats U-Matic and R-DAT, as well as A/D transfer from 1/4" and 1/2" analog tapes and transfer from CD-R discs can be done at DADC. However, PQ-encoded U-Matic tapes in the Sony 1630 format as used for CD-production is the most common format. DADC can transfer this tape into the MD format via the ATRAC Format Converter.

The following pages contain important specifications as well as necessary information sheets which have to be sent with the tape (Samples on pages 14 to 18, blank formsheets in Appendix). Please forward this information to your studio.

### General System Specifications

- The maximum recording time on premastered MD is 78 minutes 16 seconds.
- The maximum track number is 255.

### Digital Tapes

- Please send a "label copy" with the tape. On the label copy the order and duration of the titles (as it has to be on the MD) should be indicated by the producer.
- Prepare the "Premastering Instructions" form (see Appendix, form 1) which describes the

music start times with an accuracy down to one frame.

- Please note all noises (kind of noise and time at which it appears) as well as general quality notes in the "Sound & Noise Information" sheet (form 2).
- Start recording of time code and digital mute at least one minute before the first track.
- Stop recording of digital mute and time code not earlier than two minutes after the last track has ended.
- A pause (digital mute) of at least two seconds has to be kept in case you want to change the preemphasis status.

Please note that de-emphasis will be performed during format conversion at DADC.

### Additional Specifications for U-Matic Tapes

- *Sampling frequency:*  
44.1kHz
- *Tape format:*  
3/4" U-Matic NTSC standard  
(Sony PCM 1630/1610)
- *Time code:*  
SMPTE non-drop-frame; The time code has to be locked to the NTSC video-frames and must be recorded continuously and without interruption on analog channel 2 of the U-Matic tape. It may not go beyond 23h 59m 59sec 29fr.
- *PQ code:*  
The PQ data has to be stored on analog channel 1 of the U-Matic tape.

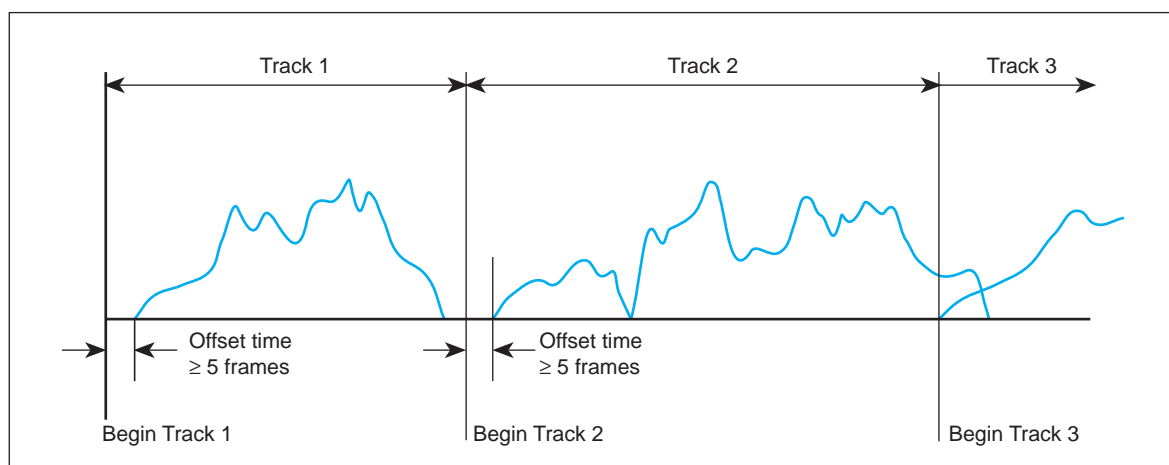



## PQ Encoding

Start recording approx. 15 sec. after Time code start. Please pay special attention to the offset-time of the begin-points. We recommend to use an offset-time of at least 5 frames to avoid that the music start is cut off during playback.

## Definitions

- "Begin" marks the start point of a track. It defines the address at which the MD player starts to playback a track.

## International Standard Recording Code (ISRC code) and UPC/EAN code (BAR code)

A disc catalogue number by means of a UPC/EAN code and the ISRC numbers as assigned by the IFPI can be recorded on every MD. For this UPC/EAN code and the ISRC numbers must be included in the original PQ Code as supplied by you or it must be specified in the "Premastering Instructions".

## Additional Specifications for R-DAT Tapes

- *Sampling frequency:* We recommend to use a sampling frequency of 44.1 kHz. Nevertheless, it is also possible to transfer from tapes with a sampling frequency of 48 kHz. Do not alter the sampling frequency within one tape.
- *Time code:* SMPTE non-drop-frame; Time code has to be locked to the NTSC video-frames and must be recorded continuously and without interruption. It may not go beyond 23h 59m 59sec 29fr.
- *PQ code:* The PQ code has to started on digital channel 1 (left channel of the DAT tape). Start recording approx. 15 sec after time code start.

Please do not send us your original master tapes. Send us continuously recorded (no assemble edits) sound checked copies.

## Analog Tapes

Please mind the following specifications:

- *Acceptable tape speeds:*  
7.9, 15, 30ips (19, 38, 76cm/s)

- *Tape widths:* 1/4", 1/2"
- *Formats:* NAB, CCIR, AES
- *Noise reduction:* Dolby A, Dolby SR
- *Reference signals: as standardized e.g: for 15ips CCIR tape:*

5sec	1kHz	0dB	left channel
5sec	1kHz	0dB	right channel
30sec	1kHz	0dB	both channels
10sec	14kHz	-10dB	both channels
10sec	63Hz	-10dB	both channels

If it is not possible to send us a tape with these test tones, please record the tones you have used for machine adjustment at the last sound-check of this tape.

If that is impossible as well, we will adjust to standard reference tones.

- *Dolby:* If you have used Dolby for noise reduction, your tape has to contain the appropriate Dolby-test-signal.

## CD-WO (CD-Write-Once)

CD-WOs have to be recorded without interruption and in accordance with the "Red Book". It must be possible to play them on standard CD-players. The CD-WOs must not contain uncorrectable errors (C2 errors). These can be caused e.g. by damage of the CD-WO (scratches, finger prints etc.), by defects during recording (medium or recording device) or by an interrupted recording. Disc checker print-outs (e.g. Sony CDA-5000 or Audio Development "CD-CATS") should be sent together with the CD-WO, if available. All data on the CD-WO (audio and PQ data, ISRC code, etc.) are transferred 1:1 onto the manufactured MDs

## Quality of the Sound Carrier

During preparation of the sound carrier, the audio information has to be carefully sound-checked. Please note every unusual noise (kind of noise and time at which it appears) in the "Sound & Noise Information" (form 2) during this sound-check. By providing this information like shown on the sample form sheets on the following pages a lot of unnecessary delays in production can be avoided. If a noise which is not mentioned on this information will be found during quality inspection at DADC, the production might be delayed.

# Premastering Instructions



Form 1

## Premastering Instructions

Catalogue No.:	1 2 3 4 5 6 7 8 9		UPC/EAN Code :	8 3 1 3 7 4 2 8 7 5 1 2 2											
Customer:	Music Company		Studio:	Record Factory											
Artist:	Sample Artist		Total Tracks:	12											
Titel:	Sample		Total Time:	46:44											
Source: <input checked="" type="checkbox"/> U-MATIC <input type="checkbox"/> ANALOG <input type="checkbox"/> DAT <input type="checkbox"/> OTHER .....															
Type of Recorder: SONY DMR - 4000															
<input type="checkbox"/> 1/4"	EQ:	NR.:	Cal. Tones:	Fs:	<input checked="" type="checkbox"/> MASTER										
<input type="checkbox"/> 1/2"	<input type="checkbox"/> CCIR	<input type="checkbox"/> NO NR.:	<input type="checkbox"/> 63/100 Hz .....dB	<input checked="" type="checkbox"/> 44.1 kHz	<input type="checkbox"/> MATERIAL										
<input type="checkbox"/> 15 IPS	<input type="checkbox"/> NAB	<input type="checkbox"/> DOLBY A	<input type="checkbox"/> 1 kHz .....dB	<input type="checkbox"/> 44.056 kHz	<input checked="" type="checkbox"/> EMPH ON										
<input type="checkbox"/> 30 IPS	<input type="checkbox"/> .....	<input type="checkbox"/> DOLBY SR	<input type="checkbox"/> 14/10 kHz .....dB	<input type="checkbox"/> 48 kHz	<input checked="" type="checkbox"/> PQ encoded										
TRK	TIME	SMPTE TC	LEVEL	FIL.	EQ						EDITS	ISRC-Code			
Nr.:	min:sec	hh:mm:ss:ff	L R	/ \	Hz	Q	dB	Hz	Q	dB	Pause,Tracks,Noises..				
1	04:08	02:00:00 06:07:03										U S T 3 8 9 2 3 0 2 1 2			
2	04:30	06:08:02 11:16:21										U S T 3 8 9 2 8 0 3 1 2			
3	05:10	11:18:07 15:56:04										U S T 3 8 9 2 3 0 3 2 1			
4	04:40	15:58:23 21:48:01										U S T 3 8 9 2 4 0 2 1 2			
5	05:50	21:48:01 26:00:00						800	2	1		U S T 3 8 9 2 6 0 2 7 3			
6	04:13	26:01:17 30:45:01										U S T 3 8 9 2 5 4 4 1 1			
7	04:48	30:49:12 36:22:12										U S T 3 8 9 2 9 0 8 1 8			
8	05:36	36:25:24 40:46:03										U S T 3 8 9 2 9 8 8 7 2			
9	04:21	40:46:07 45:31:04										U S T 3 8 9 2 3 0 2 1 2			
10	04:48	45:34:18 50:23:20										U S T 3 8 9 2 7 0 8 7 2			
11	03:20	30:49:12 36:22:12										U S T 3 8 9 2 8 8 8 7 2			
12	03:45	42:34:17 51:23:25										U S T 3 8 9 2 9 0 9 1 2			
TO BE FILLED IN BY DADC-ENGINEER:    JOB:    REMARKS:															
REF. 1K (..... dB) $\triangleq$ .....dB PCM <input type="checkbox"/> DC Offs. Corr.    DONE BY:															
DIG HR .....dB <input type="checkbox"/> EQ    DATE: 13. 02. 96															
EMPH <input type="checkbox"/> on <input checked="" type="checkbox"/> off <input type="checkbox"/> EDIT    ENG.: P.Leitner															
<input checked="" type="checkbox"/> A/B EDIT <i>De Emphasis</i>															





# Sound & Noise Information

Form 2

## Sound & Noise Information

TR #	Title: <i>Sample</i>	Artist: <i>Sample Artist</i>	Catalogue No.: <i>123456789</i>
1	EMP N	0 <i>V</i>   1   2 <i>N</i>   3 <i>V</i>   4    5	
2	EMP N	0 <i>25</i>   1   2 <i>10</i> <i>V</i>   3 <i>50</i>   4    5	
3	EMP N	0   1 <i>T</i>   2   3   4   5	
4	EMP N	0 <i>V</i>   1 <i>05</i>   2   3 <i>V</i>   4    5	
5	EMP N	0 <i>05</i>   1   2 <i>N</i>   3 <i>50</i>   4   5	
6	EMP N	0 <i>V</i>   1 <i>N</i>   2 <i>05</i>   3 <i>T</i>   4    5	
7	EMP N	0 <i>01</i>   1 <i>24</i>   2   3 <i>10</i>   4    5	
8	EMP N	0 <i>N</i>   1 <i>00</i>   2 <i>T</i>   3 <i>V</i>   4   5	
9	EMP N	0 <i>10</i>   1 <i>19</i>   2 <i>47</i>   3 <i>14</i>   4    5	
10	EMP N	0   1   2   3 <i>V</i>   4    5	
11	EMP N	0   1 <i>V</i>   2   3 <i>12</i>   4    5	
12	EMP N	0 <i>8</i>   1   2   3    4   5	
	EMP N	0   1   2   3    4   5	
REMARKS:		DATE / ENG. SIGN	
Orig. MT: ANA / DIG. / MIXED		<i>13. 02. 96</i>	
HISS, HUM, FLUTTER:		<i>P. Leitner</i>	
ROOM N., PLAY N., VOCAL N.:			

### Abbreviations for possible noise

**AE** Abrupt End, Sudden End

**BE** Bad Edit

**BL** Blow Noise, Wind Noise

**CB** Cut Begin

**CE** Cut End

**CF** Cross Fade

**CL** Click Noise

**CR** Crackle

**DB** Double Begin

**DE** Double End

**DIS** Distortion

**DO** Drop Out

**FI** Fade In

**FL** Flutter

**FO** Fade Out

**HFN** High Frequency Noise

**HISS** e.g. Tape Hiss

**I** Instrument Noise

**LCH** Left Channel

**LFN** Low Frequency Noise

**M** Mouth/Lip Noise

**MIC** Microphone

**MUS** Musician Noise

**N** Noise

**OWT** On Whole Track

**PN** Play Noise

**POP** Pop Noise

**PT** Print Through

**R** Room Noise

**RCH** Right Channel

**SB** Sudden/Abrupt Begin

**SE** Sound Effect

**T** Tick Noise

**V** Vocal Noise

## 3.2. Additional TOC Data/Character Information

As one of the new features of the MD, character information can be displayed during playback. This information is included in the TOC (table of contents) area of the MD and in subdata areas (future use) which are available in addition to the music data.

This allows to store also data like disc title, track name, disc recording date and track recording date in the TOC. For disc title and track names in total up to 2048 characters are available. This text information can be recalled during play back of the MD and then displayed on the character display of the MD player. It is recommended to use this feature for UPC/EAN Code, ISRC Code, disc- and track names.

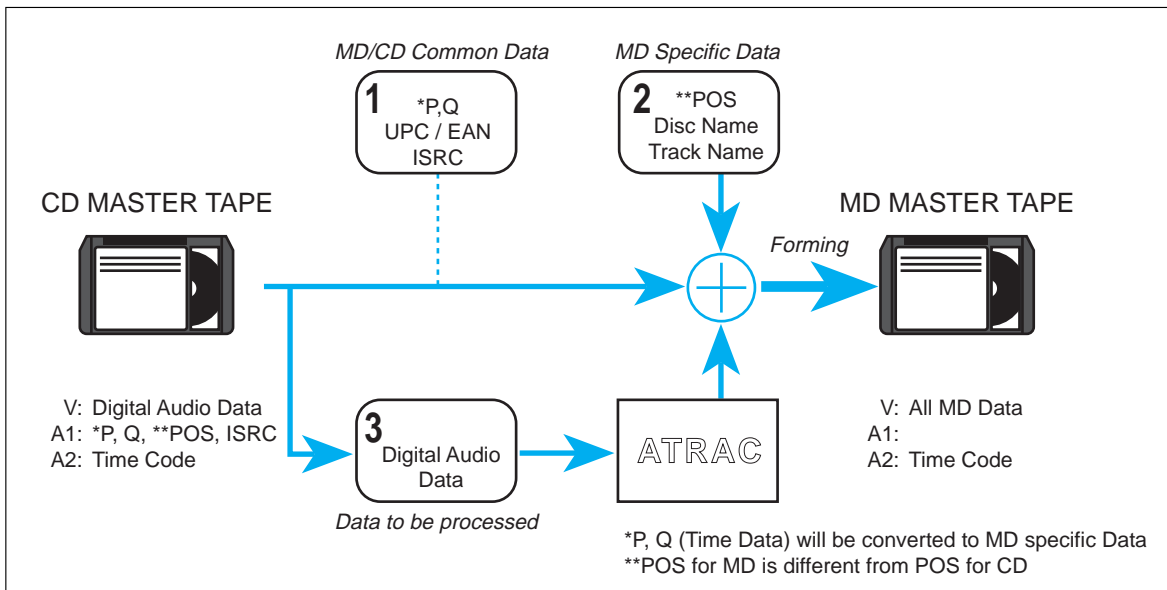

All TOC data has to be supplied together with the other production components. The MD specific character information has to be filled into the "Character Information" (form 3) as shown on sample form next page. We strongly recommend to fill in this form sheet by typewriter, or to use computer printouts in order to avoid misreadings and therefore errors in the displayed character information. Please also mind that the given information has to be 100% verified by the customer as all character information will be stored onto the MD as indicated in this form sheet. Attached please find the ASCII characters which may be used for the character information.

	0	1	2	3	4	5	6	7	8	9	A	B	C	D	E	F
0			SP	0	@	P	`	p	The symbols of this area may not be used							
1			!	1	A	Q	a	q								
2			"	2	B	R	b	r								
3			#	3	C	S	c	s								
4			\$	4	D	T	d	t								
5			%	5	E	U	e	u								
6			&	6	F	V	f	v								
7			'	7	G	W	g	w								
8			(	8	H	X	h	x								
9			)	9	I	Y	i	y								
A			*	:	J	Z	j	z								
B			+	;	K		k									
C			,	<	L		l									
D			-	=	M		m									
E			.	>	N	^	n									
F			/	?	O	_	o									

# Character Information



Form 3

## Character Information

TITLE:	ARTIST:	CATALOGUE No:	Page ... <b>1</b> of <b>3</b> ...
<b>Emotions</b>	<b>Mariah Carey</b>	<b>01-468851-50</b>	
Disc Information:	No of tracks <input type="text" value="1"/> <input type="text" value="0"/> (max 255)		
UPC/EAN - code:	<input type="text" value="5"/> <input type="text" value="0"/> <input type="text" value="9"/> <input type="text" value="9"/> <input type="text" value="7"/> <input type="text" value="4"/> <input type="text" value="6"/> <input type="text" value="8"/> <input type="text" value="8"/> <input type="text" value="5"/> <input type="text" value="1"/> <input type="text" value="8"/> <input type="text" value="7"/>		
Disc name (max. 160 characters)	<b>Mariah Carey###Emotions</b>		
Track No. <b>1</b> Information:			
ISRC - code (ISO 3901):	<input type="text" value="D"/> <input type="text" value="E"/> <input type="text" value="S"/> <input type="text" value="3"/> <input type="text" value="4"/> <input type="text" value="9"/> <input type="text" value="2"/> <input type="text" value="3"/> <input type="text" value="0"/> <input type="text" value="2"/> <input type="text" value="1"/> <input type="text" value="2"/>		
Track name (max. 160 characters)	<b>Emotions</b>		
Track No. <b>2</b> Information:			
ISRC - code (ISO 3901):	<input type="text" value="D"/> <input type="text" value="E"/> <input type="text" value="S"/> <input type="text" value="3"/> <input type="text" value="4"/> <input type="text" value="9"/> <input type="text" value="2"/> <input type="text" value="3"/> <input type="text" value="8"/> <input type="text" value="4"/> <input type="text" value="9"/> <input type="text" value="0"/>		
Track name (max. 160 characters)	<b>And You Don't Remember</b>		
Track No. <b>9</b> Information:			
ISRC - code (ISO 3901):	<input type="text" value="D"/> <input type="text" value="E"/> <input type="text" value="S"/> <input type="text" value="3"/> <input type="text" value="4"/> <input type="text" value="9"/> <input type="text" value="2"/> <input type="text" value="3"/> <input type="text" value="2"/> <input type="text" value="1"/> <input type="text" value="8"/> <input type="text" value="7"/>		
Track name (max. 160 characters)	<b>Till The End Of The Time</b>		
Track No. <b>10</b> Information:			
ISRC - code (ISO 3901):	<input type="text" value="D"/> <input type="text" value="E"/> <input type="text" value="S"/> <input type="text" value="3"/> <input type="text" value="4"/> <input type="text" value="9"/> <input type="text" value="2"/> <input type="text" value="8"/> <input type="text" value="4"/> <input type="text" value="2"/> <input type="text" value="1"/> <input type="text" value="9"/>		
Track name (max. 160 characters)	<b>The Wind</b>		

Please use # to indicate "Space characters" in case you want to use more than one "Space".

Remarks:

Signature / Date

## 3.3. Label-, Artwork- and Print Films

For unmistakable reference during production the catalogue number must be indicated on each film outside of the print area for identification.

### I. Label Film

Usually a graphic or picture will be used for the front side. For clear identification of the final MD it is necessary to include the catalogue number on the label. The MD Logo shall not be inserted, as it already appears on the upper cartridge.

During preparation of the label films please mind the following:

- Send coated positive offset films with approx. 3 mm bleed only. The registration and cutting marks must be located outside the bleed.
- The films must not reveal damage of any kind and must be packed in such a way so as to prevent folding or creasing (roll container or carton).
- In order to match label and artwork please enclose compulsory proofs regarding colour with all films.
- Please identify each film with colour specification.

All dimensions in mm with a tolerance of  $\pm 0.2$  mm

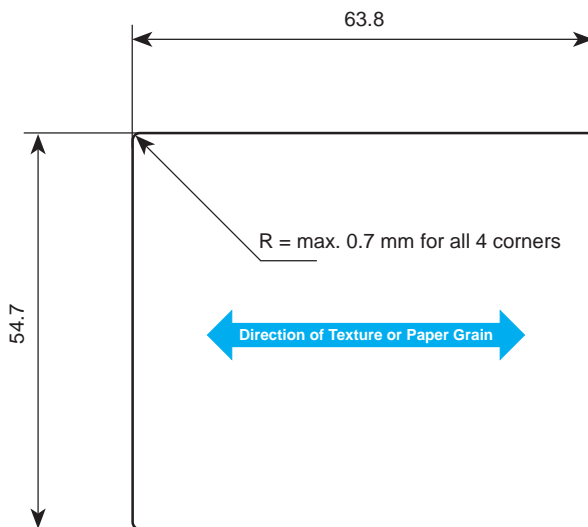

Upper Cartridge

In order to ensure optimum reliability under a variety of different operating and storage conditions DADC uses special paper quality.

## II. a) Artwork Films (Booklet)

The booklet contains similar information as CD booklets. Optionally the MiniDisc logo can be inserted. During preparation of the print films for the booklet please mind the following:

- Send coated positive offset films with approx. 3mm bleed only; the registration and cutting marks must be located outside the bleed.
- The films must not reveal damage of any kind and must be packed in such a way so as to prevent folding or creasing (roll container or carton).

- The catalogue number must appear on the cover of the booklet
- All pages (except cover outside) must contain page numbers.
- Please prepare the film layout in such a way that the booklet is closed on the left-hand side.
- Please enclose compulsory proofs regarding colour with all films.
- Please identify each film with colour specification.

All dimensions in mm with a tolerance of  $\pm 0.2$  mm

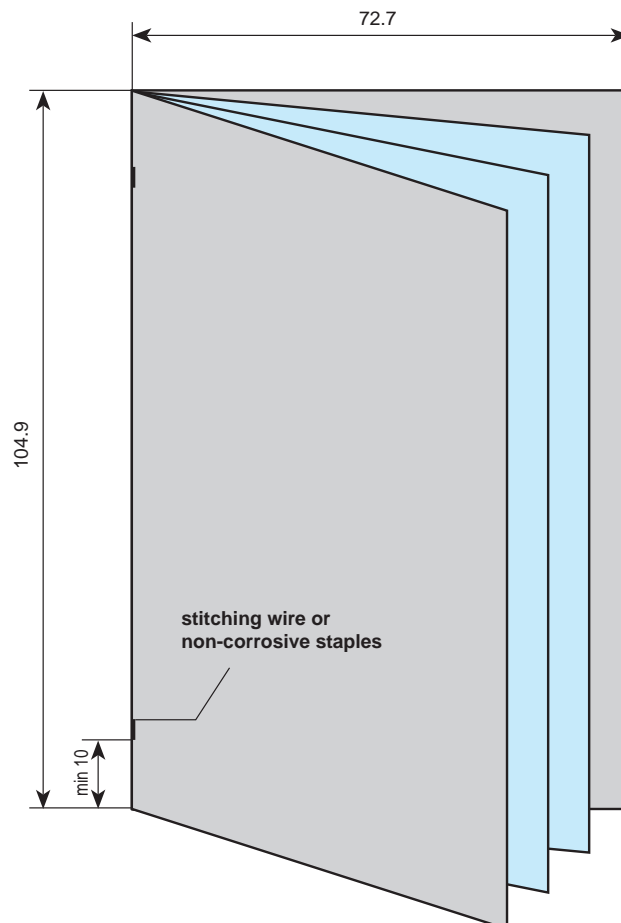

DADC will provide artwork in following quality:

Thickness:

max. 1.8 mm measured on folding side.

max. 2.3 mm measured above the stitching wire.

With 70g/m<sup>2</sup> paper quality for inner pages this will allow a max. of 32 pages.

Coverpages:

wood-free art paper.

min. 180g/m<sup>2</sup>, coated on both sides (for booklet cover and one sheet booklet).

## II. b) Artwork Films (Backline Card)

The backline card contains similar information as CD backline cards (eg.: artist, disc title, catalogue no.). The MiniDisc logo (recommended size 7mm) has to be inserted on both spines of the backline card, so that it can be easily read at top of the spine end if the MD is stored upright in a rack (see drawing below).

During preparation of the print films for the backline card please mind the following:

- Send coated positive offset films with approx. 3 mm bleed only, the registration and cutting marks must be located outside the bleed.

- The films must not reveal damage of any kind and must be packed in such a way so as to prevent folding or creasing (roll container or carton).
- The catalogue number must appear on the backline card.
- Please enclose compulsory proofs regarding colour with all films.
- Please mark each film emulsion side with the colour.
- Spine printing should be upright reading when cover up.

All dimensions in mm with a tolerance of  $\pm 0.2$  mm

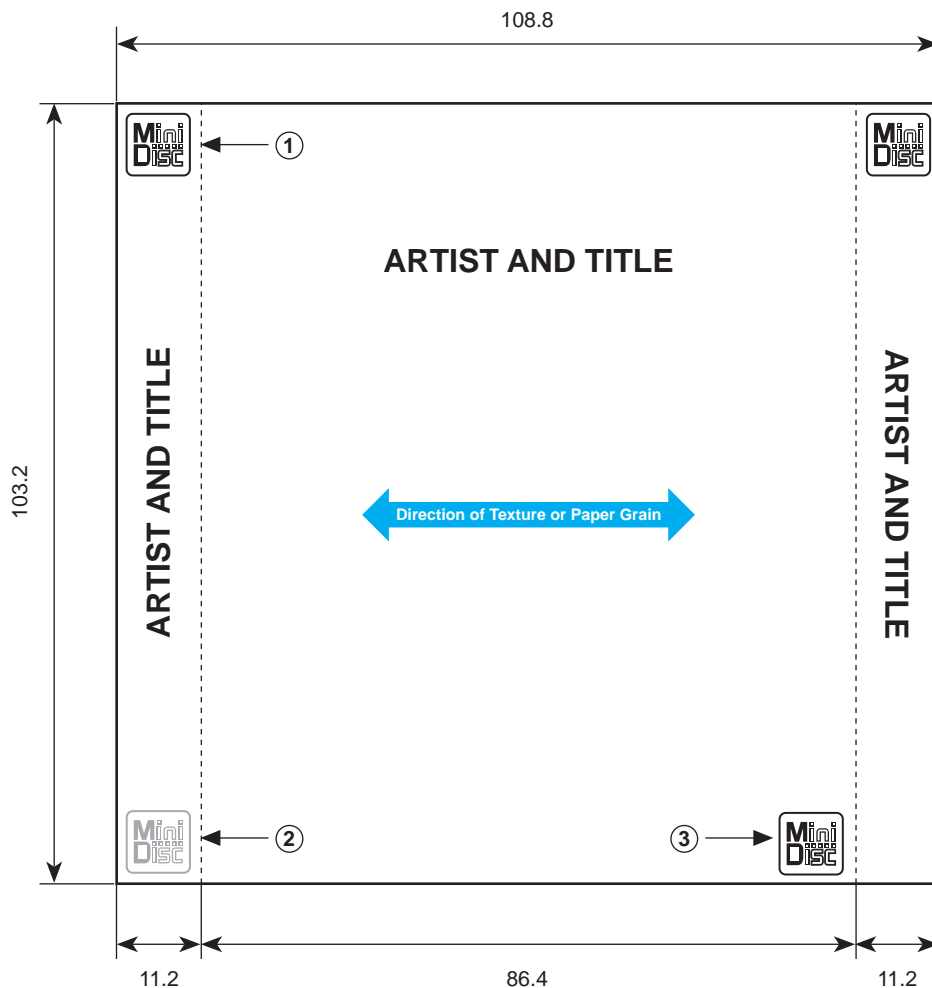

MD Logo: ①, ② ... on this spine you can choose between position ① or ②.  
③ ..... on the backside placement and position of a MD Logo is optional.

DADC will provide artwork in following quality:  
Wood-free art paper.  
160-180g/m<sup>2</sup> = 0,15 - 0,16 mm thick.  
Coated on both sides.

## III. Print Film (Cartridge Back-/Spine Print)

It is recommended to print in positive type following information with white ink on the cartridge:

*Spine:* artist name and disc title.

*Backside:* artist name, disc title, catalogue number, track titles and durations, etc.

The MD Logo shall not be inserted, as it already appears on the lower cartridge.

Print location for the spine is on the cartridge edge opposite to the loading end.

During preparation of the print film please mind the following:

- Combine spine- and backside typesetting on one film.
- Use coated positive screenprinting line films (min. line width 0.15 mm, high density, emulsion side up); positioning marks must be located outside the print area.
- The films must not reveal damage of any kind and must be packed in such a way so as to prevent folding or creasing (roll container or carton).
- Please don't encircle the printing area on the film.

All dimensions in mm

Print area dimensions:

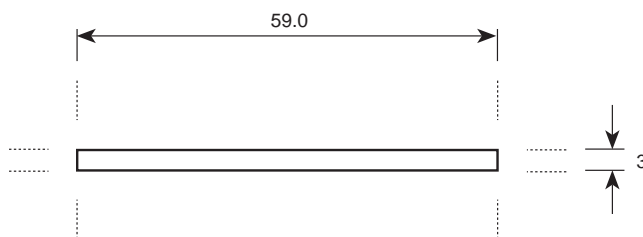

Character size 7pt

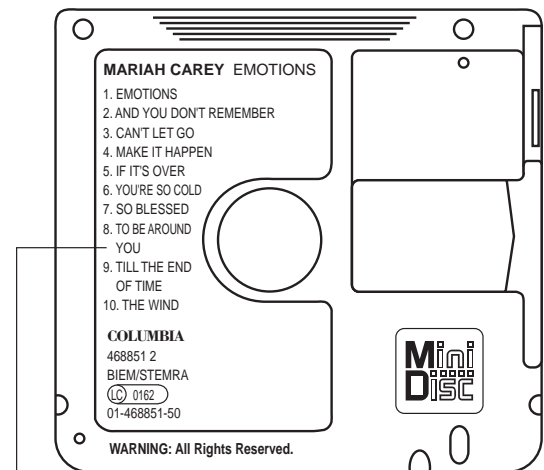
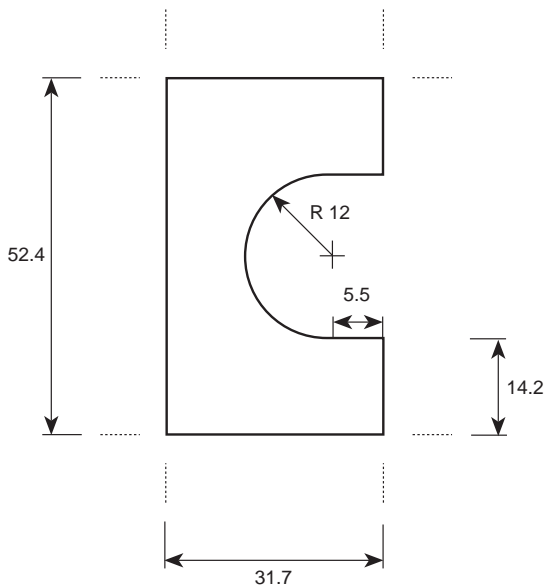

Character size min. 5pt  
min. linewidth 0.15mm

Lower Cartridge



## 3.4. The MiniDisc Logo

This part of the manual provides the rules for use of the trademark logo "MiniDisc" on discs which meet the "MD" standard specifications.

### Permitted Uses

The "MiniDisc" logo may be used pursuant to a license agreement with Sony Corporation wherein the right for usage is guaranteed. The "MiniDisc" logo can only be applied on the products specified in such a license agreement, in order to show that such products meet the "MD" standard specifications and are compatible with each other.

### Territory of Usage







The "MiniDisc" logo may be used worldwide, except in countries where the use of the trademark "MiniDisc" logo is illegal.

### "MiniDisc" Logo Specification

If you need camera-ready artwork for the logo on your label films please contact our Customer Service Department or download the logo from our website "[sonydadc.com/downloads/downfra.html](http://sonydadc.com/downloads/downfra.html)"

For the use on MD label and artwork films there are three versions of the logo, as shown below:

Choose logo A1, A2 or B, depending on the logo size. (See table below)

Logo A1	Logo A2	Logo B
		
 16mm	 7mm - 16mm	 4mm - 7mm

*Printing the “MiniDisc” logo in positive, or in reverse (negative) is permitted.*



Only one color may be used (also in negative print, only single colour backgrounds).

Never combine the “MiniDisc” logo with other characters, figures or logos. Always display it independently.

### Location

The logo should be displayed at a prominent place only once. The logo may appear in more than one place, provided such placement includes a prominent place.

Note: with respect to the logo’s use on pre-mastered discs, it should be displayed as large as possible on the backline card.

### Type Style

“MD” and “MiniDisc” may be used in typed copy in printed matter when referring to “MiniDisc” products. When typed, the letters “M” and “D” should be uppercase (capitals) and the other letters in lower case (not capitalized).

However, for the purpose of protection of the trademark, “MD” and “MiniDisc” should be enclosed within quotation marks or written in bold style in order to be prominent, and a footnote should clearly indicate that “MD” and “MiniDisc” are trademarks of Sony Corporation.



## 4. Sony DADC – The Company

Sony DADC Austria AG, is a hundred percent daughter company of the Sony Corporation, was founded in 1986 to cater to the requirements of the European CD market. Since then, the Compact Disc has emerged as the dominating sound-carrier. In 1996 more than 900 million units were sold in Europe. The CD has also become the basic technology for other optical storage products like Laser Disc, MiniDisc, CD-ROM or Play Station Disc that were introduced on the market.

With a quantity of more than 300 million CDs shipped annually Sony DADC is one of the leading

Manufacturers of optical storage media in Europe. With two plants in Salzburg and the worldwide network with subsidiaries in Japan, Hongkong, Australia, USA, Canada, Mexico and Brazil, we guarantee supply to our customers with the highest quality and top serviceability.

A separate development division with worldwide networking ensures the step ahead in production technology and is ready to meet specific customer requirements. But above all, here we create the basis for new products in the future so that we can ensure that the Sony group will be your partner in the future, too.

### Facts and Figures:

<b>Sites:</b>	Factory I - Anif/Salzburg Factory II - Thalgau/Salzburg	<b>Customers:</b>	approx. 2500 <small>(International and European music and film companies, publishers, multimedia and information providers as well as computer and video game companies and the majority of software and hardware manufacturers)</small>
<b>No. of employees:</b>	1997 approx. 950	<b>ISO 9002:</b>	Certification 1995
<b>Capacity:</b>	1997 1,2 mio/day		
<b>Production quantity:</b>	more than 300 million annually		

### Our products:

Product	Use	Size	Specification
Compact Disc	Audio	12 cm 8 cm	max. playing time 77min. max. playing time 21min. 50sec.
Laser Disc	Video	30 cm	max. playing time 120min. (two sides)
CD-ROM CD-I	Information processing/ Multimedia, Interactive Entertainment	12 cm 8 cm	max. 680 MB max. 192 MB
Video CD	Video/Film	12 cm	depending on combination audio/video/data
MiniDisc	Portable Audio	6,4 cm	playing time approx. 74 min.
PlayStation Disc	Interactive Entertainment	12 cm	max. 680 MB
CD EXTRA	Multimedia, Audio, Video, Data	12 cm 8 cm	max. 74 min. 30 sek. max. 655 MB
MD Data	like CD-ROM	6,4 cm	max. 140 MB

Notice:

This document has been prepared by DADC Austria to provide some basic information on MiniDisc (MD) for its customers.

Specific focus has been given to details as needed when ordering MD production at DADC Austria

All trademarks used in this brochure were used for editing purposes without intending any violation of an industrial property right.

Owned by: Sony DADC Austria AG  
Niederalm 282  
A-5081 Anif

Printed by: Sony Music Printing, Haarlem, NL  
Published in: Anif, A  
Produced in: Haarlem, NL

**For more information please get in touch with:**

**Sony DADC Austria AG  
Customer Service  
Niederalm 282  
A-5081 Anif, Austria**

**Tel.: ++43-6246-880-555  
Fax: ++43/6246-880-509  
E-mail: [sales@dadc.co.at](mailto:sales@dadc.co.at)**