

DENON

PORTABLE IC RECORDER

DN-F20R

OPERATING INSTRUCTIONS

MODE D'EMPLOI

INSTRUCCIONES DE OPERACIÓN

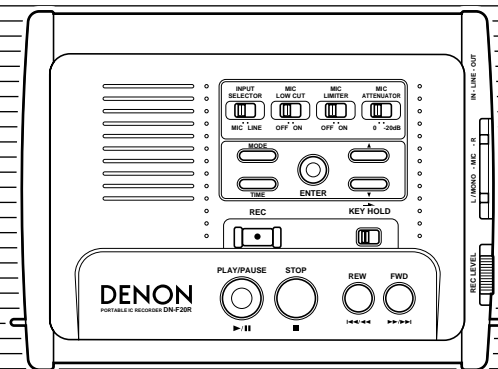

FOR ENGLISH READERS PAGE 2 ~ PAGE 33
POUR LES LECTEURS FRANCAIS PAGE 2, 34 ~ PAGE 63
PARA LECTORES DE ESPAÑOL PAGINA 2, 64 ~ PAGINA 93

“SERIAL NO. _____
PLEASE RECORD UNIT SERIAL NUMBER ATTACHED TO THE REAR OF THE
CABINET FOR FUTURE REFERENCE”

SAFETY PRECAUTIONS

CAUTION
RISK OF ELECTRIC SHOCK
DO NOT OPEN

CAUTION: TO REDUCE THE RISK OF ELECTRIC SHOCK, DO NOT REMOVE COVER (OR BACK). NO USER-SERVICEABLE PARTS INSIDE. REFER SERVICING TO QUALIFIED SERVICE PERSONNEL.

The lightning flash with arrowhead symbol, within an equilateral triangle, is intended to alert the user to the presence of uninsulated "dangerous voltage" within the product's enclosure that may be of sufficient magnitude to constitute a risk of electric shock to persons.

The exclamation point within an equilateral triangle is intended to alert the user to the presence of important operating and maintenance (servicing) instructions in the literature accompanying the appliance.

WARNING: TO REDUCE THE RISK OF FIRE OR ELECTRIC SHOCK, DO NOT EXPOSE THIS APPLIANCE TO RAIN OR MOISTURE.

CAUTION

TO PREVENT ELECTRIC SHOCK, MATCH WIDE BLADE OF PLUG TO WIDE SLOT, FULLY INSERT.

ATTENTION



POUR ÉVITER LES CHOCS ÉLECTRIQUES, INTRODUIRE LA LAME LA PLUS LARGE DE LA FICHE DANS LA BORNE CORRESPONDANTE DE LA PRISE ET POUSSER JUSQU' AU FOND.

This device complies with Part 15 of the FCC Rules. Operation is subject to the following two conditions: (1) This device may not cause harmful interference, and (2) this device must accept any interference received, including interference that may cause undesired operation.

This Class A digital apparatus meets all requirements of the Canadian Interference-Causing Equipment Regulations.

Cet appareil numérique de la classe A respecte toutes les exigences du Règlement sur le matériel brouilleur du Canada.

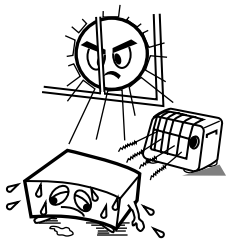
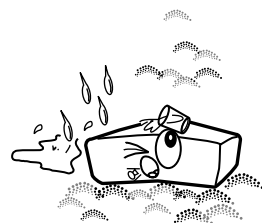
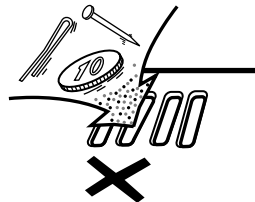
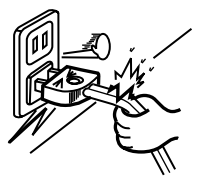
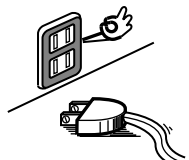
NOTE ON USE / OBSERVATIONS RELATIVES A L'UTILISATION / NOTAS SOBRE EL USO

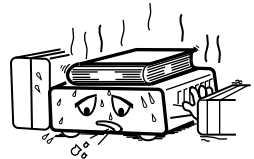
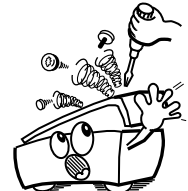
 <ul style="list-style-type: none"> • Avoid high temperatures. Allow for sufficient heat dispersion when installed on a rack. • Éviter des températures élevées. Tenir compte d'une dispersion de chaleur suffisante lors de l'installation sur une étagère. • Evite altas temperaturas. Permite la suficiente dispersión del calor cuando está instalado en la consola. 	 <ul style="list-style-type: none"> • Keep the set free from moisture, water, and dust. • Protéger l'appareil contre l'humidité, l'eau et la poussière. • Mantenga el equipo libre de humedad, agua y polvo. 	 <ul style="list-style-type: none"> • Do not let foreign objects in the set. • Ne pas laisser des objets étrangers dans l'appareil. • No deje objetos extraños dentro del equipo.
 <ul style="list-style-type: none"> • Handle the power cord carefully. Hold the plug when unplugging the cord. • Manipuler le cordon d'alimentation avec précaution. Tenir la prise lors du débranchement du cordon. • Maneje el cordón de energía con cuidado. Sostenga el enchufe cuando desconecte el cordón de energía. 	 <ul style="list-style-type: none"> • Unplug the power cord when not using the set for long periods of time. • Débrancher le cordon d'alimentation lorsque l'appareil n'est pas utilisé pendant de longues périodes. • Desconecte el cordón de energía cuando no utilice el equipo por mucho tiempo. 	 <ul style="list-style-type: none"> • Do not let insecticides, benzene, and thinner come in contact with the set. • Ne pas mettre en contact des insecticides, du benzène et un diluant avec l'appareil. • No permita el contacto de insecticidas, gasolina y diluyentes con el equipo.
 <p style="text-align: center;">* (For sets with ventilation holes)</p> <ul style="list-style-type: none"> • Do not obstruct the ventilation holes. • Ne pas obstruer les trous d'aération. • No obstruya los orificios de ventilación. 	 <ul style="list-style-type: none"> • Never disassemble or modify the set in any way. • Ne jamais démonter ou modifier l'appareil d'une manière ou d'une autre. • Nunca desarme o modifique el equipo de ninguna manera. 	

<p>DECLARATION OF CONFORMITY We declare under our sole responsibility that this product, to which this declaration relates, is in conformity with the following standards: EN60950, EN55013, EN55020, EN61000-3-2 and EN61000-3-3. Following the provisions of 73/23/EEC, 89/336/EEC and 93/68/EEC Directive.</p>	<p>DECLARATION DE CONFORMITE Nous déclarons sous notre seule responsabilité que l'appareil, auquel se réfère cette déclaration, est conforme aux standards suivants: EN60950, EN55013, EN55020, EN61000-3-2 et EN61000-3-3. D'après les dispositions de la Directive 73/23/EEC, 89/336/EEC et 93/68/EEC.</p>	<p>DECLARACIÓN DE CONFORMIDAD Declaramos bajo nuestra exclusiva responsabilidad que este producto al que hace referencia esta declaración, está conforme con los siguientes estándares: EN60950, EN55013, EN55020, EN61000-3-2 y EN61000-3-3. Siguiendo las provisiones de las Directivas 73/23/EEC, 89/336/EEC y 93/68/EEC.</p>
---	--	--

SAFETY INSTRUCTIONS

1. Read Instructions – All the safety and operating instructions should be read before the appliance is operated.
2. Retain Instructions – The safety and operating instructions should be retained for future reference.
3. Heed Warnings – All warnings on the appliance and in the operating instructions should be adhered to.
4. Follow Instructions – All operating and use instructions should be followed.
5. Water and Moisture – The appliance should not be used near water – for example, near a bathtub, washbowl, kitchen sink, laundry tub, in a wet basement, or near a swimming pool, and the like.
6. Carts and Stands – The appliance should be used only with a cart or stand that is recommended by the manufacturer.
- 6A. An appliance and cart combination should be moved with care. Quick stops, excessive force, and uneven surfaces may cause the appliance and cart combination to overturn.
7. Wall or Ceiling Mounting – The appliance should be mounted to a wall or ceiling only as recommended by the manufacturer.
8. Ventilation – The appliance should be situated so that its location or position does not interfere with its proper ventilation. For example, the appliance should not be situated on a bed, sofa, rug, or similar surface that may block the ventilation openings; or, placed in a built-in installation, such as a bookcase or cabinet that may impede the flow of air through the ventilation openings.
9. Heat – The appliance should be situated away from heat sources such as radiators, heat registers, stoves, or other appliances (including amplifiers) that produce heat.
10. Power Sources – The appliance should be connected to a power supply only of the type described in the operating instructions or as marked on the appliance.
11. Grounding or Polarization – Precautions should be taken so that the grounding or polarization means of an appliance is not defeated.
12. Power-Cord Protection – Power-supply cords should be routed so that they are not likely to be walked on or pinched by items placed upon or against them, paying particular attention to cords at plugs, convenience receptacles, and the point where they exit from the appliance.
14. Cleaning – The appliance should be cleaned only as recommended by the manufacturer.
15. Power Lines – An outdoor antenna should be located away from power lines.
16. Outdoor Antenna Grounding – If an outside antenna is connected to the receiver, be sure the antenna system is grounded so as to provide some protection against voltage surges and built-up static charges. Article 810 of the National Electrical Code, ANSI/NFPA 70, provides information with regard to proper grounding of the mast and supporting structure, grounding of the lead-in wire to an antenna-discharge unit, size of grounding conductors, location of antenna-discharge unit, connection to grounding electrodes, and requirements for the grounding electrode. See Figure A.
17. Nonuse Periods – The power cord of the appliance should be unplugged from the outlet when left unused for a long period of time.
18. Object and Liquid Entry – Care should be taken so that objects do not fall and liquids are not spilled into the enclosure through openings.
19. Damage Requiring Service – The appliance should be serviced by qualified service personnel when:
 - A. The power-supply cord or the plug has been damaged; or
 - B. Objects have fallen, or liquid has been spilled into the appliance; or
 - C. The appliance has been exposed to rain; or
 - D. The appliance does not appear to operate normally or exhibits a marked change in performance; or
 - E. The appliance has been dropped, or the enclosure damaged.
20. Servicing – The user should not attempt to service the appliance beyond that described in the operating instructions. All other servicing should be referred to qualified service personnel.

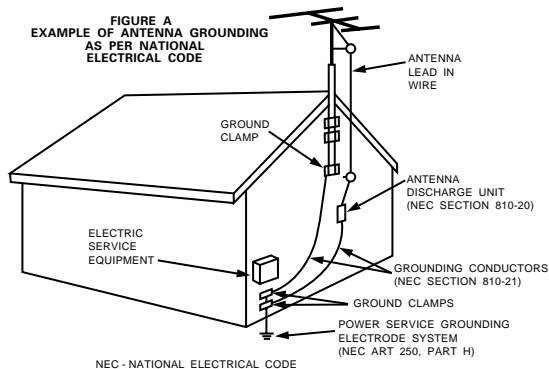

TABLE OF CONTENTS

1 Features.....4	8 Recording18~23
2 Power supply.....5, 6	9 Editing and erasing files24~26
3 IC memory cards.....7~9	10 Other operations.....27, 28
4 Preset mode.....10, 11	11 Troubleshooting.....29~31
5 Setting the internal clock.....12	12 Parallel remote jack32
6 Part Names and Functions.....13~15	13 Specifications.....33
7 Playback.....16, 17	

■ ACCESSORIES

Check that the following parts are included in addition to the main unit:

1 Operating instructions1	4 Strap1
2 Warranty (for North America model)1	5 AC adaptor (AA-24).....1
3 Soft cover1	6 AC cord.....1

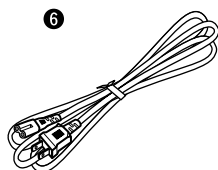
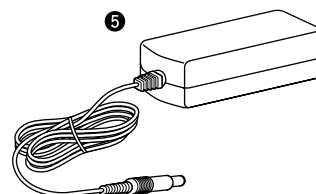
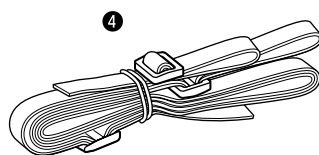
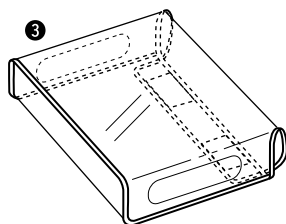

(North America and Canada models)

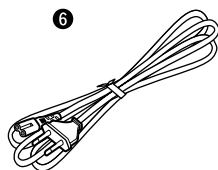

(Europe and Asia models)

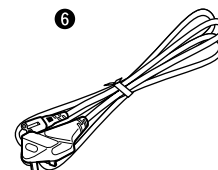

(U.K. model)

1 FEATURES

1. The DN-F20R uses IC memory cards as the recording medium, achieving a highly reliable design with no moving mechanisms.
 2. The set uses the MPEG format, an international standard for high compression and high sound quality.
 3. The DN-F20R is also compatible with linear PCM recording (WAVE file recording).
 4. The set is equipped with XLR microphone input terminals.
 5. Despite being equipped with XLR terminals, the DN-F20R is a small A5 size, so it is easy to carry around.
 6. IC memory cards containing recorded sources are recorded in DOS (16 bit FAT) file format, so they can be edited on PC systems (*1).
- (*1) Using an ATA adaptor for insertion into PCMCIA slots.
7. The audio quality (recording bit rate) can be selected according to the application so that cards can be used efficiently.
 8. The DN-F20R uses LR6 (AA size) alkaline batteries that can easily be found when traveling.

2 POWER SUPPLY

■ The DN-F20R can be powered using commercially available batteries or the included AC adaptor.

About batteries

[1] Battery type

Use LR6 (AA size) alkaline batteries in the DN-F20R.
Do not use manganese batteries, as they may generate heat.

Battery usage time

- The set will operate approximately 4 hours on new batteries with one memory card and in the normal recording mode.
- When the battery power gets low, the battery mark  appears on the display window.
Once the battery mark appears, the set can be used for about 10 more minutes. Replace the batteries with new ones soon.
- ※ The usage times are rough guides, and may be longer or shorter depending on the temperature and the type of battery.
- ※ Be sure to turn off the set's power and unplug the AC adaptor before replacing the batteries.
- ※ If the set detects that the battery power is low within several minutes after the power is turned on, the power may turn off immediately.

Cautions on batteries

- Use LR6 (AA size) alkaline batteries in the DN-F20R.
- Be sure to insert the batteries in the proper direction, following the ⊕ and ⊖ marks indicated in the battery compartment.
- To avoid damage or leakage of fluid:
 - Do not use new batteries together with used batteries or use different types of batteries together.
 - Do not short-circuit, take apart, heat or dispose of batteries in flames.
- Remove the batteries when you do not plan to use the set for long periods of time.
- Remove spent batteries from the set immediately.
- Should the batteries leak, carefully wipe off the fluid from inside the battery compartment, then insert new batteries.
- If a battery's alkaline fluid should leak and get in your eyes or on your skin or clothes, this could cause blindness or injury. If this should happen, rinse thoroughly with clean water and consult a physician immediately.

[2] Inserting the batteries

- 1 Open the lid of the battery compartment.
 - Slide the lever on the set's bottom panel in the direction of arrow ①, then remove the battery compartment lid in the direction of arrow ②.

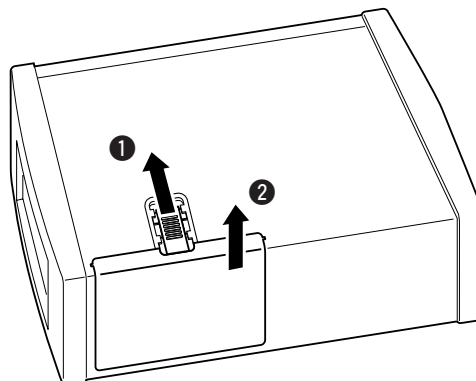

- 2 Insert the batteries.
 - Insert the LR6 (AA size) alkaline batteries (6 batteries) in the directions indicated by the marks in the battery compartment.

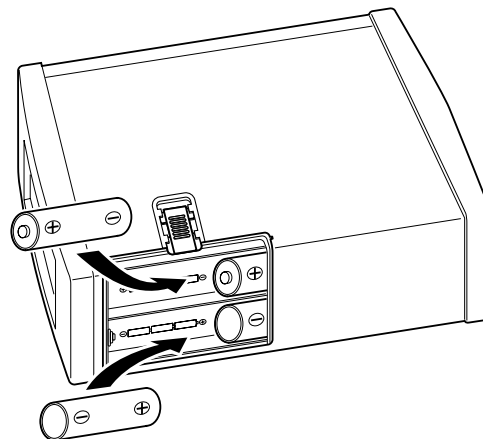

- 3 Close the lid.
 - Slide the lever in the direction of arrow ①, then set the battery compartment lid back in its original position.

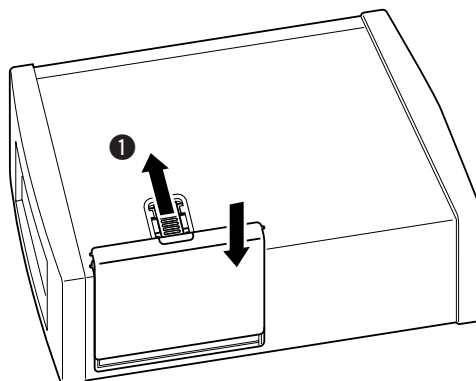

AC adaptor

Connecting the AC adaptor

- 1** Turn the set's power switch off.

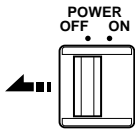

※ Check that the display is off.

- 2** Plug the AC cord's FEMALE PLUG into the AC input side of the AC adaptor.

Example: North America model

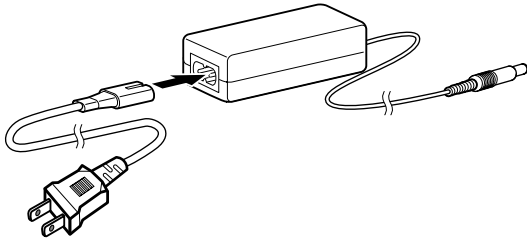

- 3** Plug the AC adaptor's DC plug into the set's DC jack.

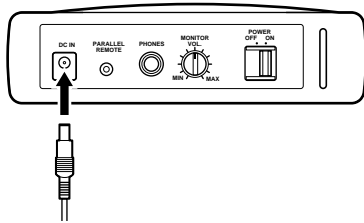

- 4** Plug the AC cord into a power outlet.

Example: North America model

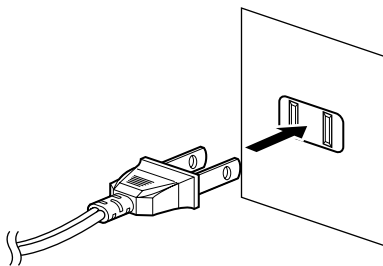

Cautions on using the AC adaptor

- Only use the included AC adaptor.
- Be sure to turn the set's power switch off when connecting or disconnecting the AC adaptor.
- The set or the IC memory card could be damaged if the set's power is turned on when the AC adaptor is connected or disconnected.

※ AUTO POWER OFF function is not available when the set is operated with the AC adaptor.

3 IC MEMORY CARDS

Cards to be used (recording media)

- The DN-F20R uses IC memory cards as the recording medium. Denon IC memory cards are sold separately.
- In addition to Denon IC memory cards, we also recommend the following SanDisk Compact Flash™ (*1) cards:

SanDisk	
Model	Capacity
SDCFB-32	32MB
SDCFB-40	40MB
SDCFB-48	48MB
SDCFB-64	64MB
SDCFB-80	80MB

(*1) Compact Flash™ is a registered trademark of SanDisk.

- ※ The above table is valid as of February, 2000. Some cards may no longer be produced or sold.

Note

- The DN-F20R accesses (reads and writes) large amounts of audio data on the IC memory card in real time. In order to process this data, the IC memory card itself must offer sufficiently high access speed. If cards other than Denon IC memory cards or the recommended Compact Flash cards are used, it may happen that the IC memory card's access speed is too slow, in which case recordings may randomly stop or normal recording may not be possible. Also, the set may not be able to properly identify cards other than the recommended Compact Flash cards.

Recording time

The recordable time on the DN-F20R depends on the card capacity and recording bit rate. A formula for roughly calculating the recording time and examples are provided below.

- Calculating the recording time (approximate)
 - Card capacity (MB) × 1024 (kByte) × 8 (bit) = Card capacity (kbit)
 - Card capacity (kbit) ÷ Recording bit rate (kbps) ÷ Number of channels = Recording time (sec)
 - Recording time (sec) ÷ 60 = Recording time (min)

Example: With a 32 MB card

Recording mode	Recording bit rate	Approx. recording time	Formula
LINEAR PCM	768 kbps, STEREO (=2ch)	2.8 min	$32 \times 1024 \times 8 \div 768 \div 2 \div 60 = 2.8$
	768 kbps, MONO (=1ch)	5.6 min	$32 \times 1024 \times 8 \div 768 \div 1 \div 60 = 5.6$
MPEG1*1	128 kbps, STEREO (=2ch)	17 min	$32 \times 1024 \times 8 \div 128 \div 2 \div 60 = 17$
	128 kbps, MONO (=1ch)	34 min	$32 \times 1024 \times 8 \div 128 \div 1 \div 60 = 34$
MPEG2*2	64 kbps, STEREO (=2ch)	34 min	$32 \times 1024 \times 8 \div 64 \div 2 \div 60 = 34$
	64 kbps, MONO (=1ch)	68 min	$32 \times 1024 \times 8 \div 64 \div 1 \div 60 = 68$

*1 ISO/IEC 11172-3 MPEG1 Layer2 16bit Fs = 48kHz

*2 ISO/IEC 13813-3 MPEG2 Layer2 16bit Fs = 24kHz

- ※ The recording time may decrease if small files of about 10 kB or less in size are created.

Formatting

■ Format type

The DN-F20R is only compatible with the 16-bit FAT format. Attempting to use cards formatted in the 12-bit FAT format will result in card errors. If this happens, format the card on the DN-F20R (note that when this is done any data on the card is deleted). The set automatically formats cards in the 16-bit FAT format. Also note that when 12-bit FAT cards are formatted in 16-bit FAT format on the DN-F20R, some PC applications may no longer be able to recognize them.

■ Cluster size

The cluster size is the smallest unit of data when writing on IC memory cards.

The cluster size may change when cards are formatted on PCs or any devices other than the DN-F20R.

To ensure proper recording, the set carefully checks not only the card's own access speed but also the cluster size. Changing the cluster size may result in card errors, even when using a recommended card. If this happens, format the card on the DN-F20R.

■ Double recording (1 & 2 REC card mode)

Even higher speed is required for double recording, so be sure to use recommended IC memory cards of the same maker, the same model (capacity) and the same cluster size for double recording.

As long as the cards' manufacturer and cluster size are the same, recording may be possible even if the models (capacities) are different. If recording is not possible, either the recording will stop or an error message will be displayed when recording starts.

Directories and file organization

- When the set's power is turned on or a card is inserted, the set checks the card. If the standard directories listed below are not in the IC memory card's root directory at this time, they are created automatically.
- The default directory is "MPGLANG1". Use the "▲" and "▼" buttons to select the directory. When recording, the files are automatically given names consisting of the last digit of the directory name and a number from 001 to 999.

Standard directory names	This unit's display	Automatically given audio file names
MPGLANG0	DIR0	0001.mpg (or 0001.wav) ~ 0999.mpg (or 0999.wav)
MPGLANG1	DIR1	1001.mpg (or 1001.wav) ~ 1999.mpg (or 1999.wav)
MPGLANG2	DIR2	2001.mpg (or 2001.wav) ~ 2999.mpg (or 2999.wav)
MPGLANG3	DIR3	3001.mpg (or 3001.wav) ~ 3999.mpg (or 3999.wav)
MPGLANG4	DIR4	4001.mpg (or 4001.wav) ~ 4999.mpg (or 4999.wav)
MPGLANG5	DIR5	5001.mpg (or 5001.wav) ~ 5999.mpg (or 5999.wav)
MPGLANG6	DIR6	6001.mpg (or 6001.wav) ~ 6999.mpg (or 6999.wav)
MPGLANG7	DIR7	7001.mpg (or 7001.wav) ~ 7999.mpg (or 7999.wav)
MPGLANG8	DIR8	8001.mpg (or 8001.wav) ~ 8999.mpg (or 8999.wav)
MPGLANG9	DIR9	9001.mpg (or 9001.wav) ~ 9999.mpg (or 9999.wav)

- ※ If there are over 999 files or a file named "x999.mpg" (or "x999.wav") in a directory, it is no longer possible to record in that directory.
- ※ Audio files in directories other than the ones listed above are not recognized by the set.
- ※ Audio file names are given the extension "mpg" for MPEG files, "wav" for linear PCM files.
- ※ The automatically given audio file names can be changed. (See page 24.)
- ※ A maximum of 255 directories and files can be created in the root directory. An error results if the above directories cannot be created in the root directory.

Loading memory cards

- 1 Open the card slot cover.
 - Press on the upper left corner of the cover to unlock and open it.

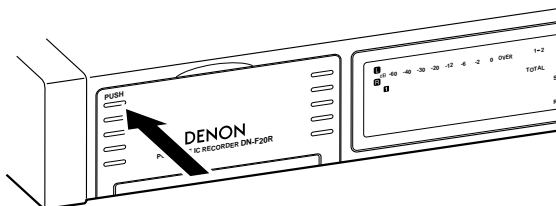

- 2 Insert the memory card.
 - The upper card slot is slot 1, the lower card slot is slot 2.
 - ※ Be sure to insert the cards in the proper direction.

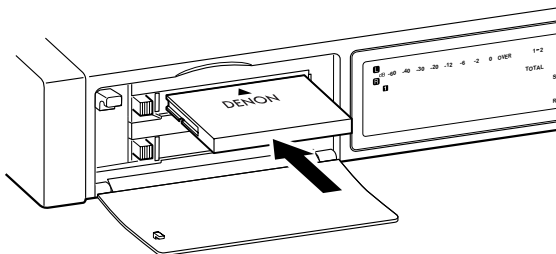

- 3 Lower the eject lever by pushing it to the left.
 - When pressed, the card is pushed out. Grasp the card and remove it.

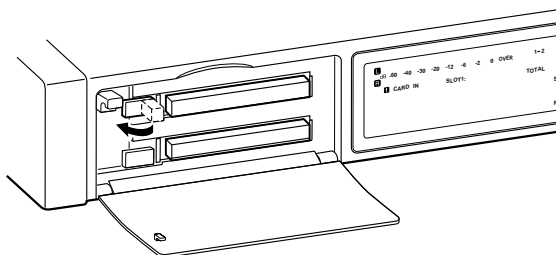

- 4 Close the card slot cover.
 - The cover locks when it is pushed in.

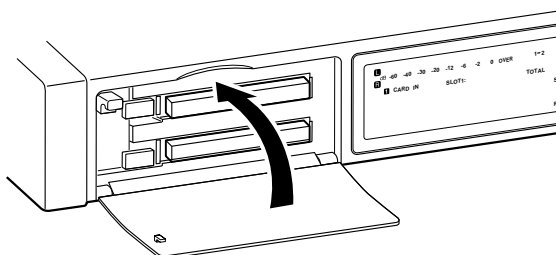

Cautions on handling IC memory cards

- Do not disassemble or modify cards.
- Do not touch the terminals with your fingers or with metal objects.
- Do not bend, drop or subject to shock.
- Avoid heat and moisture.
- Do not use misshapen cards. Doing so may damage the card slot.

Removing memory cards

- 1 Open the card slot cover.
 - Press on the upper left corner of the cover to unlock and open it.

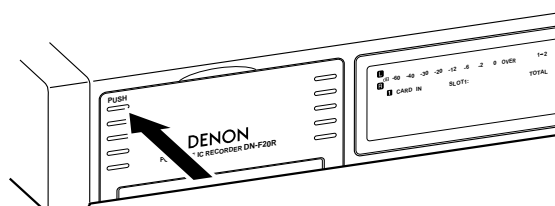

- 2 Lift the eject lever.
 - Lift the eject lever on the left side of the card slot to be removed.

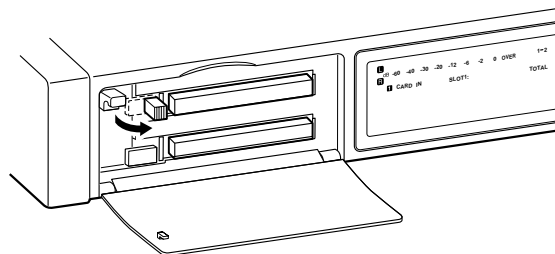

- 3 Press the eject lever.
 - When pressed, the card is pushed out. Grasp the card and remove it.

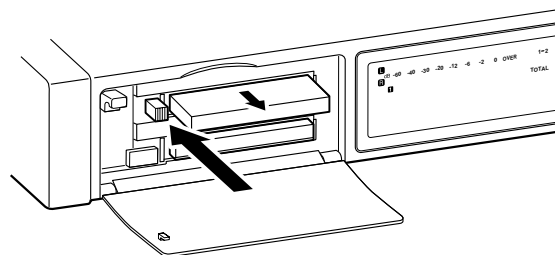

Cautions on loading and ejecting cards

- Never remove a card from a slot while the slot's access mark "▲" is lit on the display window. Removing the card while the mark is lit may damage the set or the card.
- Do not load or eject cards while "HELLO" is displayed on the display window after the power is turned on.
- It is not possible to close the card slot cover when the eject lever is raised. Trying to force it will result in damage. Be sure to lower the eject lever by pushing it to the left before closing the card slot cover.
- Be sure to load cards securely so that they do not fall out due to vibrations, etc.
- If possible, only load or eject cards when the power is off.
- If you must eject a card while the power on, check that the slot is not in use before doing so.
- Even after turning the power off, wait until the display turns completely off before loading or ejecting cards.

4 PRESET MODE

- Before using the set, preset the various options according to the intended usage.
The preset settings are stored in the memory even when the power is turned off.

Preset items

- REC FORM:** Recording mode (compression/decompression and stereo/mono) settings
LINEAR 48kHz STEREO / LINEAR 48kHz MONO / *MPEG 48kHz (Hi) STEREO / MPEG 48kHz (Hi) MONO / MPEG 24kHz (Lo) STEREO / MPEG 24kHz (Lo) MONO
- REC BIT RATE:** Bit rate setting for file recording
24kHz = 16k / 24k / 32k / 40k / 48k / *64k
48kHz = 64k / *128k
- FILE SORT:** File sorting order (file name/date recorded, ascending or descending) setting
*FILE NAME <UP> / FILE NAME <DOWN> / FILE DATE <UP> / FILE DATE <DOWN>
- DATE/TIME ADJ:** Internal clock date and time setting
1999/01/01 ~ *2000/01/01 ~ 2098/12/31
- REC CARD MODE:** Card recording method (relay recording or double recording) setting
*1→2 or 2→1 REC / 1&2 REC
- PLAY MODE:** Play mode setting
*CONTINUOUS PLAY / SINGLE PLAY
- AUTO POWER OFF:** Auto power off time setting (Valid only in battery operation.)
OFF / 1min / *5min / 10min
- BACK LIGHT TIMER:** Back light time setting
CONTINUOUS / 5sec / *10sec
- MODE LOCK:** Mode setting lock or unlock
LOCK / *UNLOCK

(*) Default setting

Preset operations

- The preset options can only be set in the stop mode.
Use the following buttons for preset operations:

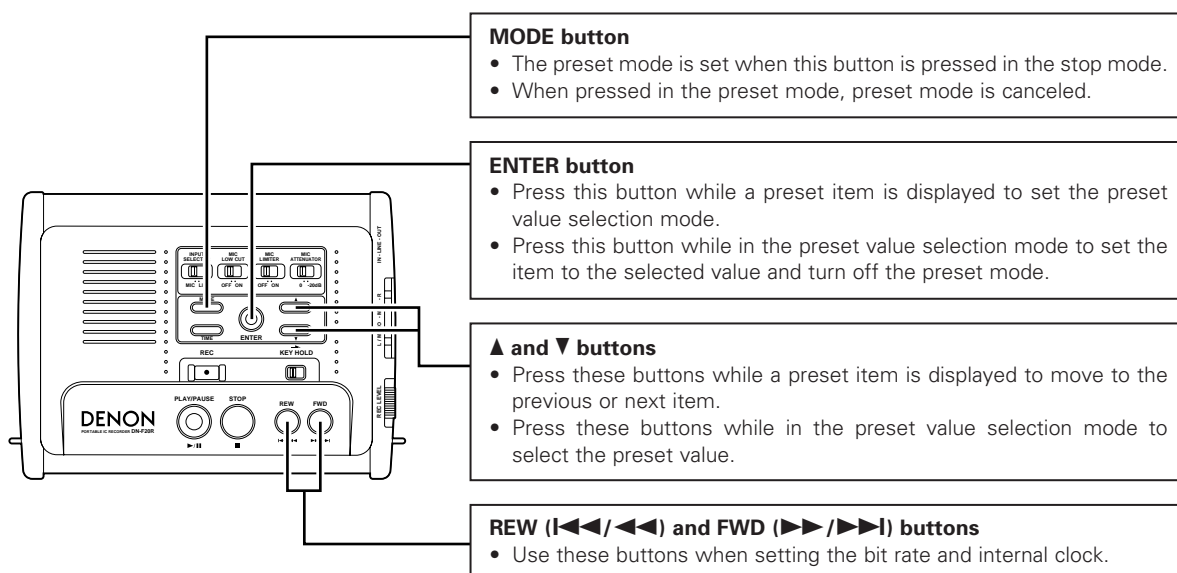

- Set the preset items according to your usage purpose using the button operational flow chart described below.
- ※ Press the MODE button to cancel the preset mode.

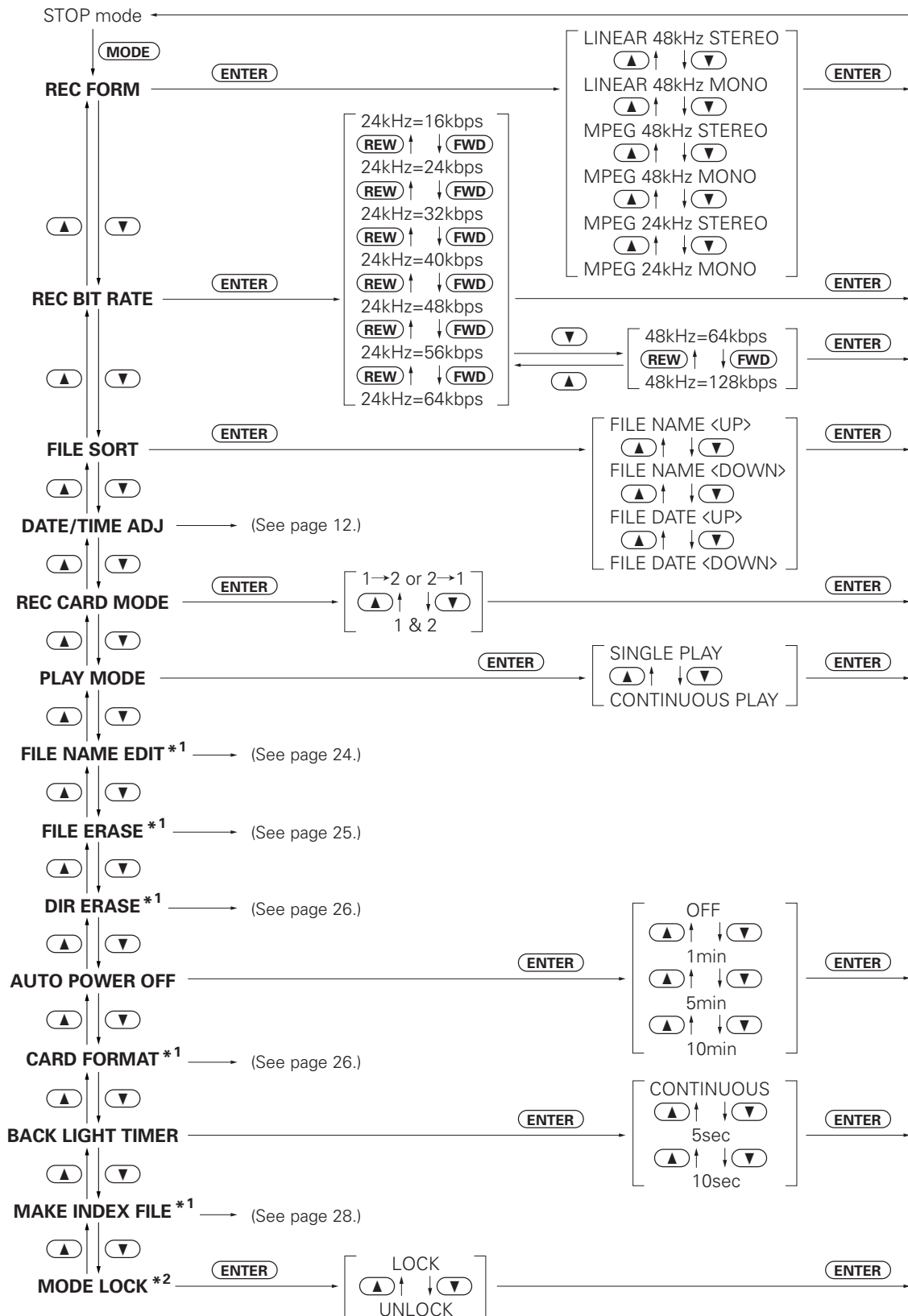

*1 Some selections may not be possible depending on whether cards are loaded, whether files are present, and other conditions.

*2 The "MODE LOCK" setting is provided so that modes cannot be changed accidentally. When "LOCK" is set for "MODE LOCK", it is not possible to set other modes by pressing the MODE button unless "MODE LOCK" is set back to "UNLOCK".

5 SETTING THE INTERNAL CLOCK

- The DN-F20R is equipped with an internal clock function for managing the dates and times at which files are recorded. Be sure to set the clock before using the set for the first time.
- The DN-F20R is equipped with a battery for backing up the internal clock. If the date and time display flashes every time the power is turned on, the internal battery is worn down. Have it replaced by your store authorized DENON servicing agent.

Setting the internal clock

- 1** In the stop mode, press the MODE button.
- The preset mode is set.

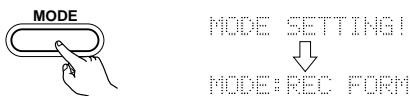

- 2** Select the data setting mode.
- Press the ▼ button 3 times to display "MODE:DATE/TIME ADJ".

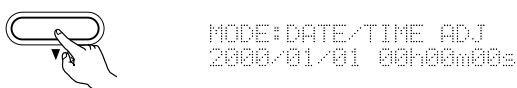

- 3** Press the ENTER button.
- The year display (4 digits) flashes, and the setting change mode is set.



- 4** Set the year.
- Press the FWD button to move one year forward. (*1)
 - Press the REW button to move one year backward. (*1)

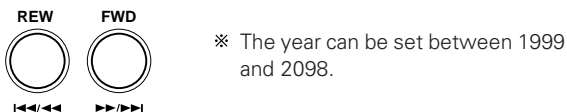

- 5** Press the ▼ button.
- The month display (2 digits) starts flashing.



- 6** Set the month.
- Press the FWD button to move one month forward. (*1)
 - Press the REW button to move one month backward. (*1)

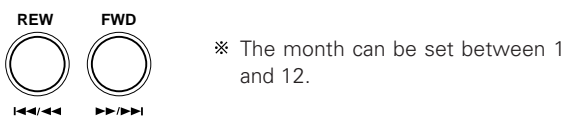

- 7** Press the ▼ button.
- The day display (2 digits) starts flashing.

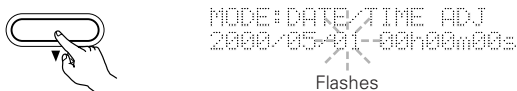

- 8** Set the day.
- Press the FWD button to move one day forward. (*1)
 - Press the REW button to move one day backward. (*1)

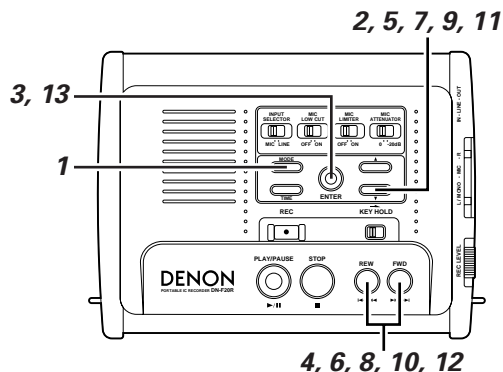
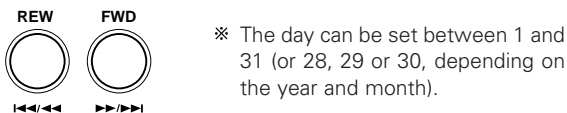

- 9** Press the ▼ button.
- The hour display (2 digits) starts flashing.

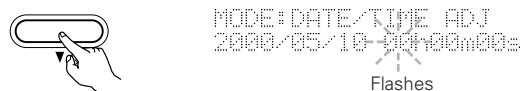

- 10** Set the hours.
- Press the FWD button to move one hour forward. (*1)
 - Press the REW button to move one hour backward. (*1)

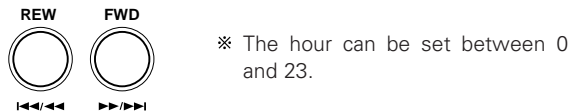

- 11** Press the ▼ button.
- The minute display (2 digits) starts flashing.

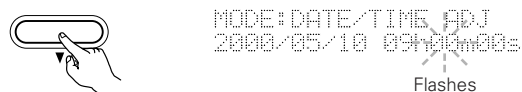

- 12** Set the minutes.
- Press the FWD button to move one minute forward. (*1)
 - Press the REW button to move one minute backward. (*1)

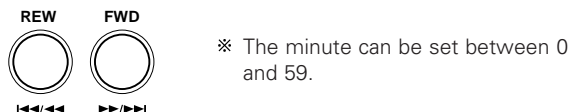

- 13** Press the ENTER button.
- The set date and hour are entered and the stop mode is set.



* When the ENTER button is pressed, the seconds are reset to 00.

(*1) The value changes continuously when the button is held down.

6 PART NAMES AND FUNCTIONS

Front panel

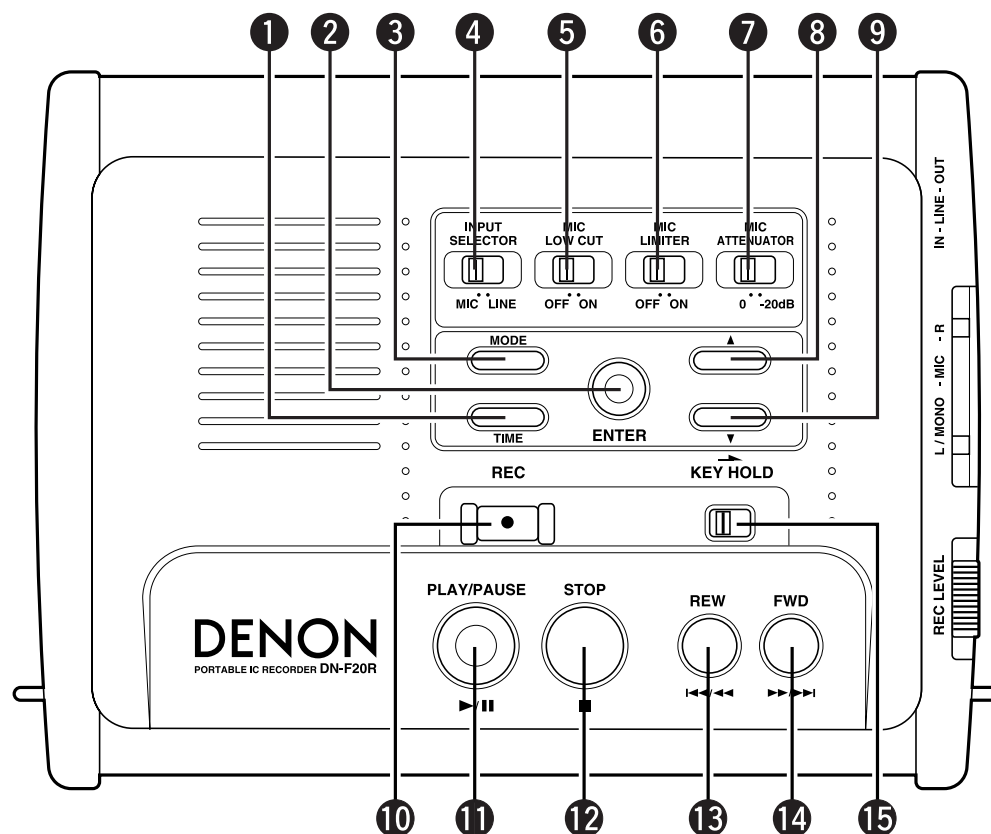

- 1 TIME button**
Use this to switch the TOTAL time/REMAIN time display.
- 2 ENTER button**
Use this to enter mode settings.
- 3 MODE button**
Use this to set the preset mode. When pressed while in the preset mode, the preset mode is canceled.
- 4 INPUT SELECTOR switch**
Use this to set the recording input signal source to the microphone input (MIC) **26** or line input (LINE) **27**.
- 5 MIC LOW CUT switch**
When this is turned on, the low frequency portion of the microphone input signal is cut.
- 6 MIC LIMITER switch**
When this is turned on, distortion due to excessive microphone input is reduced.
- 7 MIC ATTENUATOR switch**
Use this to set the microphone gain according to the microphone being used.
- 8 ▲ (up) button**
- In the stop mode, press this to move to the previous directory.
 - In the preset mode, use this to move to the previous preset item.
- 9 ▼ (down) button**
- In the stop mode, press this to move to the next directory.
 - In the preset mode, use this to move to the next preset item.
- 10 REC (●) button**
- When pressed in the stop mode, the record pause mode is set.
 - When pressed during recording or record pause mode, the file number is incremented.
- 11 PLAY/PAUSE (▶/||) button**
- When pressed in the stop or play pause mode, playback starts.
 - When pressed in the play mode, the play pause mode is set.
 - When pressed in the record pause mode, the recording mode is set.
- 12 STOP (■) button**
- When pressed, play or record (play pause or record pause) mode is canceled and the stop mode is set.
 - When pressed in the stop mode, the current date and time and the file sorting order are displayed.
 - When pressed in the file name change mode, the character is erased.
- 13 REW (◀◀/◀) button**
- When pressed in the play or play pause mode, the card is played (paused) from the beginning of the current file or the beginning of the previous file according to the sorting order. When held in, the manual search mode is set in the reverse direction.
 - When pressed in the stop mode, the position moves back to the previous file according to the sorting order. When held in, the position moves back 10 files at a time.
- 14 FWD (▶▶/▶) button**
- When pressed in the play or play pause mode, the card is played (paused) from the beginning of the next file according to the sorting order. When held in, the manual search mode is set in the forward direction.
 - When pressed in the stop mode, the position moves forward to the next file according to the sorting order. When held in, the position moves forward 10 files at a time.
- 15 KEY HOLD switch**
When set to the HOLD side, the operating buttons are locked. Switches **4** to **7**, and **19** are not locked.

Front side

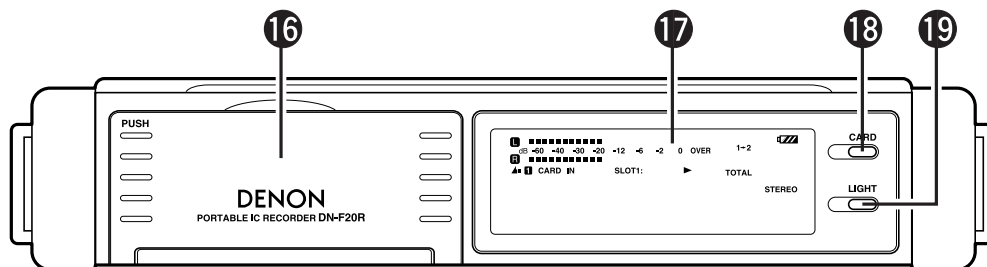

Left side

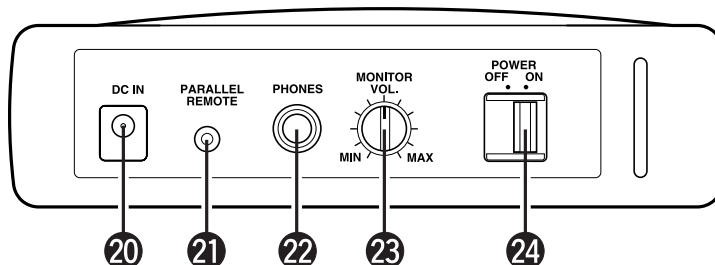

Right side

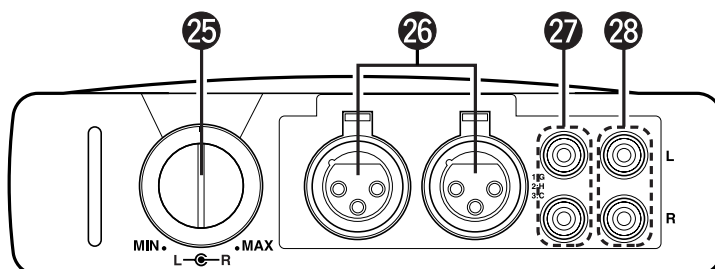

- 16 Card slot cover**
Press the upper left corner of the cover (marked "PUSH") to open it.
- 17 LCD display**
- 18 CARD button**
Use this to select the current card.
- 19 LIGHT button**
Use this to turn the LCD's back light on (or off).
- 20 DC IN terminal**
This is the DC input terminal for using the included AC adaptor.

Only use the included AC adaptor. Using other adaptors may result in fire or electric shock.

- 21 PARALLEL REMOTE input terminal**
Use this input terminal to connect external control signals.
- 22 PHONES output terminal**
When headphones are plugged in, the set's monitor speaker turns off.
- 23 MONITOR VOL. control**
Use this to adjust the volume of the monitor speaker and headphones.
- 24 POWER ON/OFF switch**
Use this switch to turn on the set's power.
- 25 REC LEVEL control**
Use this to adjust the recording level.
The outer control is for the left channel, the inner control for the right channel.

- 26 MIC input connector**
These are XLR type connectors for microphone signal input.
Pin layout: 1 – Ground (G)
2 – Hot (H)
3 – Cold (C)

* Use less than 600Ω/ohms impedance microphone.
- 27 LINE IN terminals**
These are input terminals for connecting line signals.
- 28 LINE OUT terminals**
These are output terminals for connecting line signals.

Turn the power switch "OFF" state before connecting or disconnecting the each terminal.

Cautions on using the POWER OFF/ON switch

- "HELLO" appears on the display window after the power is turned on. The set is being initialized while this is displayed. Doing not load or eject cards or perform any operations at this time.
- When the set's power is turned off, final processing is performed on the card. Do not eject cards, disconnect the AC adaptor or remove the batteries at this time. If the final processing is not performed, the data will not be properly written on the card and the card may be damaged.
- Even when the power switch is OFF, a very small current will flow inside the unit.
When the unit will not be in use for a long period, be sure to remove the batteries and disconnect the AC cord from the outlet.

Display

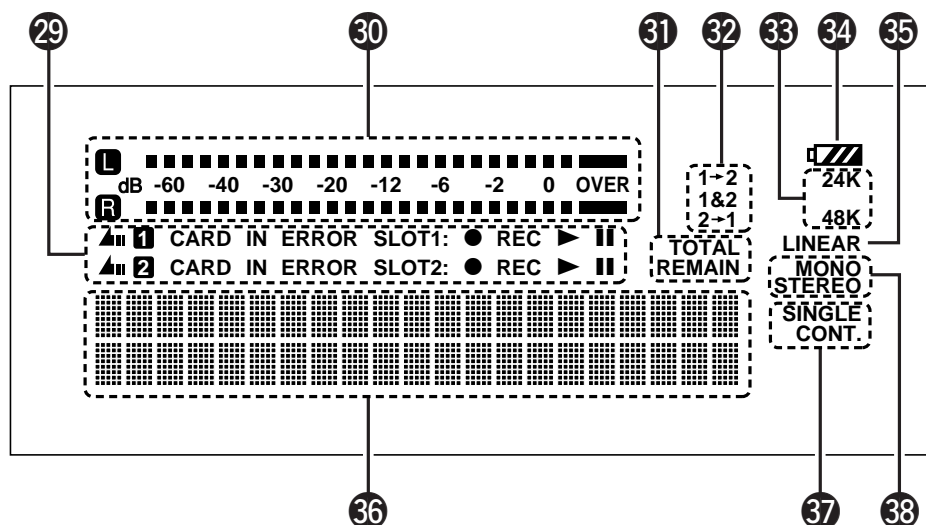
**29 Card slot indicators**

"▲" lights when the card slot is being accessed.

※ Never remove cards while the "▲" mark is lit.

When a card is loaded, "CARD IN" lights.

"CARD ERROR" lights if there is an error with the loaded card.

"SLOT1" or "SLOT2" lights to indicate the current slot (the slot for which operations are currently being performed).

"● REC ►" lights when the current slot is set to the recording mode, "● REC |||" lights when it is set to the record pause mode, "►" lights when it is in the play mode, and "|||" lights when it is in the play pause mode.

30 Level meter display

This indicates the recording input or playback output level. The peak level is held.

31 TOTAL/REMAIN indicators

"TOTAL" lights when the total (elapsed) time is displayed.

"REMAIN" lights when the remaining time is displayed.

32 Recording mode indicators

1→2 : Continuous recording from slot 1 to 2

1&2 : Double recording to slots 1 and 2

2→1 : Continuous recording from slot 2 to 1

33 24K/48K indicators

These indicate the current recording or playback sampling frequency.

In the stop mode, they indicate the preset sampling frequency.

※ In the linear PCM mode, "48K" is lit.

34 Battery mark

The battery mark  lights when the battery power gets low.

35 LINEAR indicator

This lights when in the linear PCM (non-compression) mode.

36 Character display

Directory names, file names, the card status, time information, messages, etc., are displayed here.

37 SINGLE and CONT. indicators

SINGLE : Single file play mode

CONT. : Continuous play mode

38 MONO and STEREO indicators

MONO : Monaural recording (play) mode

STEREO : Stereo recording (play) mode

Current

- With this set, the slot, directory and file for which the various operations are currently being performed are referred to as the current slot, current directory and current file.

7 PLAYBACK

Starting playback

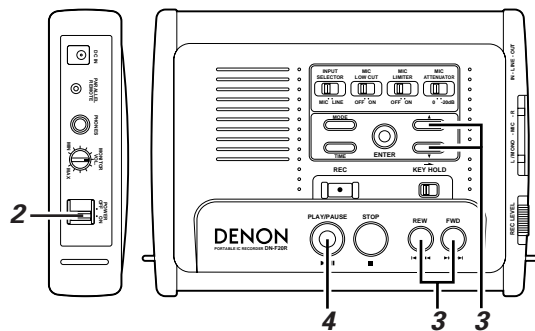

1 Insert a card in a card slot.
 • Be sure to insert the card in the proper direction. (See page 9.)

2 Turn on the power.
 • Set the POWER switch on the left side to "ON" to turn on the set's power.

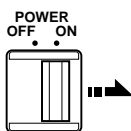

※ If the power was turned off with the auto power off function, first set the POWER switch to the "OFF" side, then set it back to "ON".

• The card is checked automatically and the current file is displayed.

```

Directory name/file name          Bit rate
DIR1\1001                        128k
00h15m47s 03/03 15:03
Total file time                  Current date and time
    
```

3 Select the file to be played.
 • If you wish to play a file other than the one that is currently displayed, select the directory containing the file, then select the file.

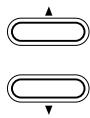

• Press the ▲ button to move to the previous directory.
 • Press the ▼ button to move to the next directory.

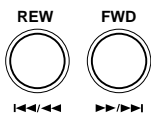

• Press the FWD button to move to the next file.
 • Press the REW button to move to the previous file.

4 Press the PLAY/PAUSE button.
 • Playback starts.



Stopping playback

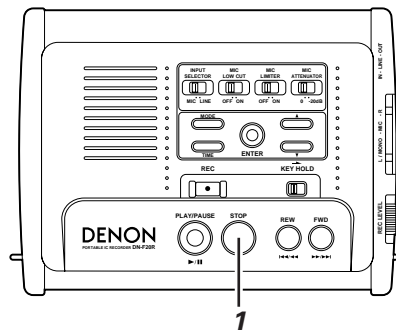

1 During playback, press the STOP button.
 • Playback stops.

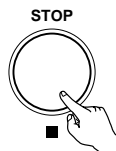

※ The stop mode is set automatically once file playback has ended (in the continuous play mode, once all the files have been played).

Adjusting the volume of the headphones or monitor speaker

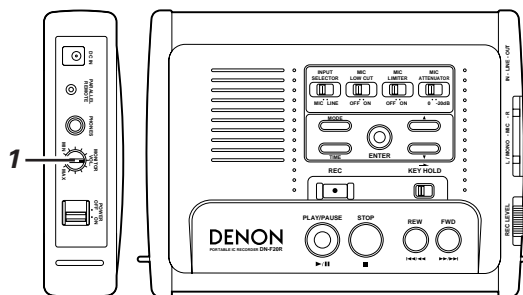

1 Turn the MONITOR VOL. control on the left side to adjust the volume.
 • Turning the control in the clockwise direction increases the volume and turning it in the counterclockwise direction decreases the volume.

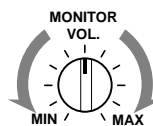

※ The monitor speaker is turned off when headphones are plugged into the PHONES jack.

When using headphones, be careful not to turn the volume up too high. Listening over headphones for extended periods of time at high volumes can have adverse effects on your hearing.



Stopping playback temporarily **[Pause]**

- 1 During playback, press the PLAY/PAUSE button.
 - Playback is paused.



- ※ To resume playback from the position at which it was paused, press the PLAY/PAUSE button again.
- ※ If the time set for the auto power off function is reached while in the pause mode, the pause mode is canceled and the power turns off.

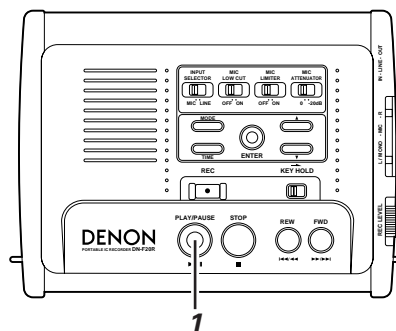

Searching for a specific position within a file **[Manual search]**

- Use this function to skip forward (or backward) through a file to find the desired position. This function comes in handy for finding the desired position within long files.

[1] Forward search

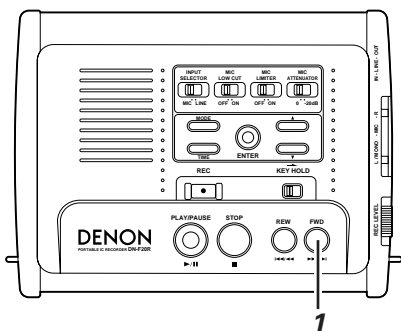

- 1 During playback, press and hold in the FWD (▶▶/▶▶▶) button.

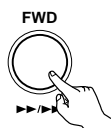

- Normal playback resumes from the point at which the button is released.

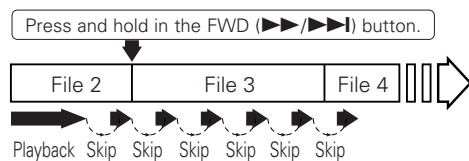

- ※ In the single mode, searching stops automatically when the end of the current file is reached. In the continuous mode, searching stops automatically when the end of the last searchable file is reached.

- ※ To search forward without listening to the sound, press and hold in the FWD (▶▶/▶▶▶) button while in the pause mode. Manual searching in the pause mode is faster than manual searching in the play mode. The pause mode is set at the position at which the button is released. In the single mode, the pause mode is set when the end of the current file is reached. In the continuous mode, the pause mode is set when the end of the last searchable file is reached.

[2] Reverse search

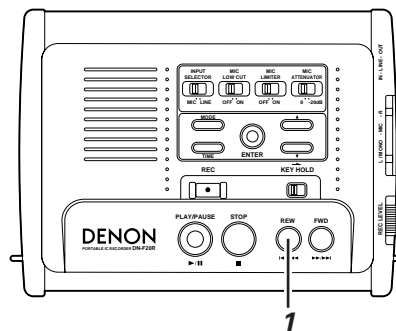

- 1 During playback, press and hold in the REW (◀◀/◀◀◀) button.

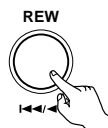

- Normal playback resumes from the point at which the button is released.

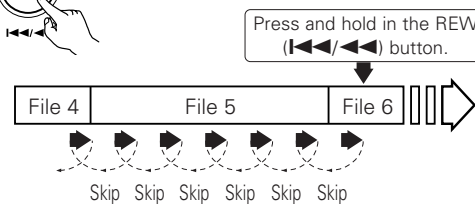

- ※ In the single mode, normal playback begins when the button is released at the beginning of the current file. In the continuous mode, normal playback begins when the button is released at the beginning of the first searchable file.

- ※ To search backward without listening to the sound, press and hold in the REW (◀◀/◀◀◀) button while in the pause mode. Manual searching in the pause mode is faster than manual searching in the play mode. The pause mode is set at the position at which the button is released. In the single mode, the pause mode is set when the button is released at the beginning of the current file. In the continuous mode, the pause mode is set when the button is released at the beginning of the first searchable file.

8 RECORDING

- Pay attention to the remaining time when recording on a partially recorded card. We recommend backing up the partially recorded card beforehand using a PC system (not included), etc.
- If you wish to record on an already recorded card from which you will erase unnecessary files, erase the unnecessary files first. (See pages 25 and 26.)

Starting recording

The DN-F20R offers two types of recording onto IC memory cards: normal (relay: 1→2 or 2→1) recording and double (1 & 2) recording. Set the card recording mode beforehand in the preset mode.

■ Normal (relay: 1→2 or 2→1) recording

This is the normal recording mode. The sound is recorded onto either the card in slot 1 or the one in slot 2. When the end of the recordable time on the card in slot 1 is reached during recording and a card is loaded in slot 2, recording continues (relays) on the card in slot 2.

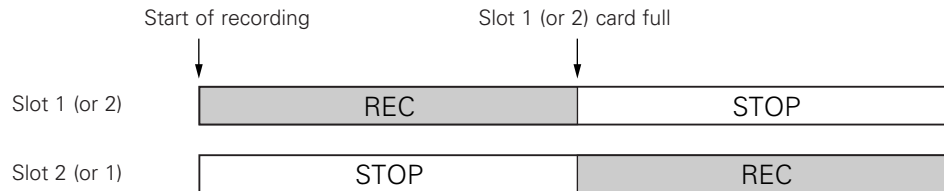

- ※ For relay recording, load the card in the other slot at least 30 seconds before the recordable time on the card currently being recorded is up. If the next card is loaded when there is little recordable time remaining on the card currently being recorded, the set may not have enough time to check the card, in which case recording will not be relayed and the stop mode will be set.
- ※ If recording is not possible on the card in the next slot, recording stops once the recordable time on the card currently being recorded is up. Recording is not possible if there is no remaining recordable time on the card or if the card already contains the maximum number of files. A message is displayed in the dot matrix section if recording is not possible.
- ※ Relay recording is only possible in the same directories on the cards in slots 1 and 2. Relay recording is not possible if that directory on the card in the next slot already contains the maximum number of files.

■ Double (1 & 2) recording

In this mode, the cards in slots 1 and 2 are recorded simultaneously. Use this mode to make backups of audio files as you record. If audio files are already recorded on one of the cards, recording stops once that card is full.

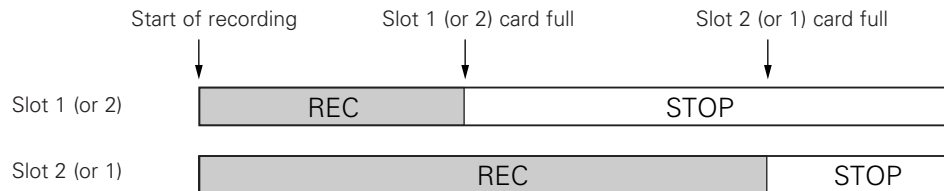

- ※ When the recording mode is set to double (1 & 2) recording, recording is performed with the same file names in the same directories of the cards in slots 1 and 2. Recording will not start unless recordable cards are loaded in both slots. To record on one card only, preset the recording mode to normal recording.
- ※ With double recording, the cards are accessed at high speed, so be sure to use recommended IC memory cards of the same make, the same model (capacity) and the same cluster size (even when the cluster size has been changed on a PC, etc.). As long as the cards' manufacturer and cluster size are the same, recording may be possible even if the models (capacities) are different. If recording is not possible, either recording will stop or an error message will be displayed when recording starts.

■ Setting the card recording mode

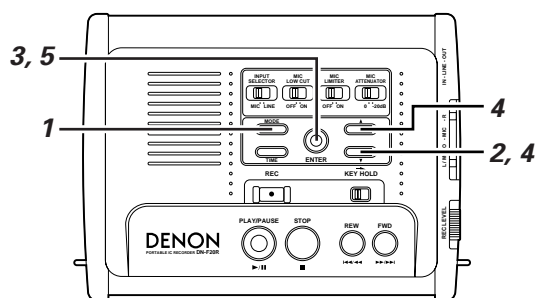

- 1** In the stop mode, press the MODE button.
- The preset mode is set.

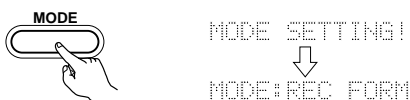

- 2** Select the card recording mode.
- Press the ▼ button to display “REC CARD MODE”.



- 3** Press the ENTER button.
- The card recording mode menu is set.



- 4** Select the card recording mode.
- Use the ▲ and ▼ buttons to select normal or double recording.

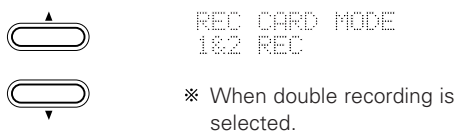

- 5** Press the ENTER button.
- The setting is entered and the stop mode is set.



※ If “MODE LOCK” is set to “LOCK”, set it to “UNLOCK” before setting the card recording mode.

Recording formats (compression/decompression and stereo/mono)

The DN-F20R offers a choice of three recording compression/decompression formats (linear PCM, MPEG1 Layer 2, and MPEG2 Layer 2 LSF – see below) and the choice of stereo or monaural recording.

■ Linear PCM

Recording is performed without compression, with a sampling frequency of 48 kHz and a quantization bit number of 16 bits.

This recording format offers the maximum sound quality possible on the DN-F20R, but the quantity of data per unit time is large, so it uses up much card space.

※ Because the quantity of data per unit time is large, the card access speed must be high. Recording in linear PCM may not be possible on IC memory cards with small cluster sizes and capacities of 16 MB or less. If recording is not possible, either recording will stop or an error message will be displayed when recording starts.

■ MPEG1 Layer 2

Recording is performed with a sampling frequency of 48 kHz and a quantization bit number of 16 bits, but with compression, so that the quantity of data is about 1/6 to 1/12 that of linear PCM recordings.

With this mode, the card space can be used efficiently.

■ MPEG2 Layer 2 LSF (Low Sampling Frequency)

Recording is performed with a sampling frequency of 24 kHz, a quantization bit number of 16 bits, and compression achieving a data quantity of between about 1/12 to 1/48 that of linear PCM recordings.

Because the quantity of data per unit time is small, the frequency response is set to about 11 kHz, reducing the frequency band of the compressed data to maintain sound quality. With this mode, the card space can be used at its highest efficiency.

■ Stereo/monaural

Stereo or monaural recording can be selected for all three compression/decompression formats. With monaural recording, the file size is half that of stereo recordings.

■ Setting the recording format (compression/decompression and stereo/mono)

- 1** In the stop mode, press the MODE button.
- The preset mode is set.



- 2** Press the ENTER button.
- The recording format mode is set.



- 3** Select the recording format.
- Use the ▲ and ▼ buttons to select the recording format.

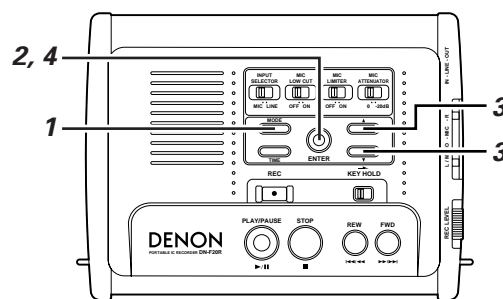

- 4** Press the ENTER button.
- The selection is stored and the stop mode is set.



※ If "MODE LOCK" is set to "LOCK", set it to "UNLOCK" before setting the card recording mode.

Recording bit rates

With the DN-F20R, the bit rate can be selected as described below for the different recording compression/decompression formats.

■ Linear PCM

The bit rate is fixed to 768 kbps per channel.

■ MPEG1 Layer 2

The bit rate can be set to either 128 kbps or 64 kbps per channel.

Lowering the bit rate lowers the sound quality, but also reduces the file size.

■ MPEG2 Layer 2 LSF (Low Sampling Frequency)

The bit rate can be set to either 64 kbps, 56 kbps, 48 kbps, 40 kbps, 32 kbps, 24 kbps or 16 kbps per channel.

Lowering the bit rate lowers the sound quality, but also reduces the file size.

■ Setting the recording bit rate

- 1** In the stop mode, press the MODE button.
- The preset mode is set.

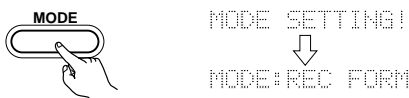

- 2** Select the recording bit rate setting mode.
- Press the ▼ button to display "RECORDING BIT RATE". The currently set recording bit rate is displayed.



- 3** Press the ENTER button.
- The 24 kHz mode is set.



- 4** Select the 24 kHz recording bit rate.
- Use the REW and FWD buttons to select the bit rate.

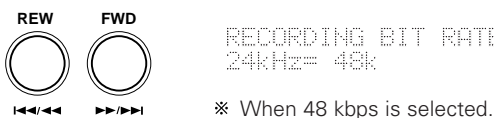

- 5** Set the 48 kHz mode.
- Use the ▲ and ▼ buttons.

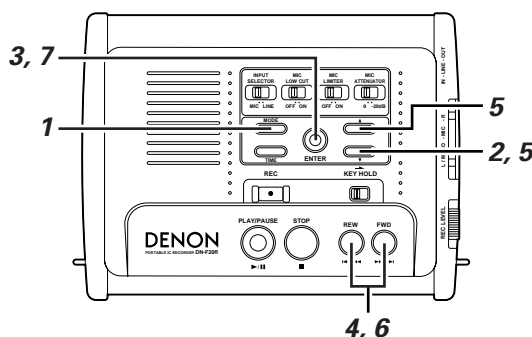

- 6** Select the 48 kHz recording bit rate.
- Use the REW and FWD buttons to select the bit rate.

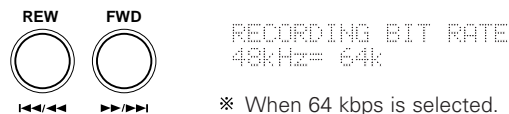

- 7** Press the ENTER button.
- The selections are stored and the stop mode is set.



* If "MODE LOCK" is set to "LOCK", set it to "UNLOCK" before setting the card recording mode.

Starting recording

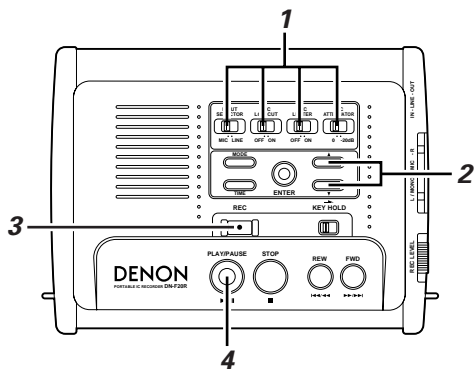

- 1** Select the input source.
- Use the INPUT SELECTOR switch to select "MIC" or "LINE".

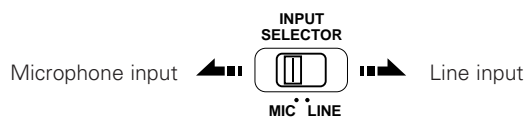

- When "MIC" is selected, set the MIC LOW CUT, MIC LIMITER and MIC ATTENUATOR switches according to the source signal and the type of microphone being used.

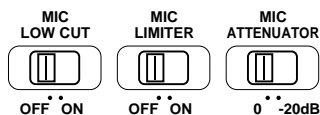

- If there is much low frequency noise in the background due to wind, etc., set the MIC LOW CUT switch to "ON" to cut out the low frequency portion.
- When the MIC LIMITER is set to "ON", distortion due to excessive microphone input is reduced.
- If the microphone sensitivity is high and the sound is hard to adjust using the REC LEVEL control, set the MIC ATTENUATOR switch to "-20dB".
- When you use only one microphone, plug the microphone to the L/MONO input terminal and set to "MONO" in the "REC FORM" preset mode.

- 2** Select the directory into which you want to record.
- To record in a directory other than the one currently displayed, select the desired directory as follows:

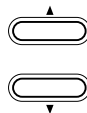

- Press the ▲ button to move to the previous directory.
- Press the ▼ button to move to the next directory.

- 3** Press the REC button.
- The file name is incremented and the recording pause mode is set.

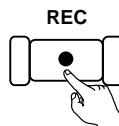

Directory number/file name Recording time Bit rate

```
3\3001 00h00m00s 128k
SLOT2:NO CARD! 128k
```

※ Set the time display to "REMAIN" to display the remaining recordable time. (See page 27.)

- 4** Press the PLAY/PAUSE button.
- Recording starts.



- When the REC button is pressed during recording, the file name is incremented and recording continues.
- The input signal can be monitored by headphones or LINE OUT while in the record or record pause modes.

Adjusting the recording level

- 1** Watching the level meter display, turn the REC LEVEL control on the right side to adjust the recording level.
- Turning the control in the clockwise direction increases the recording level and turning it in the counterclockwise direction decreases the recording level.

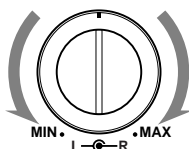

※ The outer control is for the left channel, the inner control for the right channel.

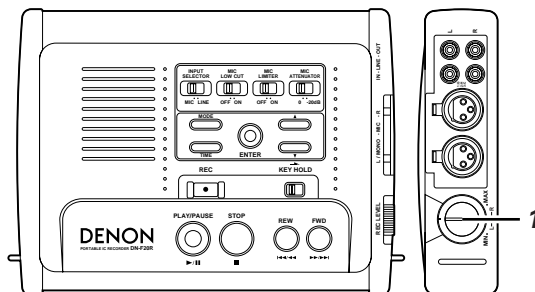

Stopping recording

- 1** In the recording mode, press the STOP button.
- Recording stops.

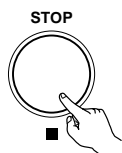

※ Recording cannot be stopped within 0.5 seconds after it was started.

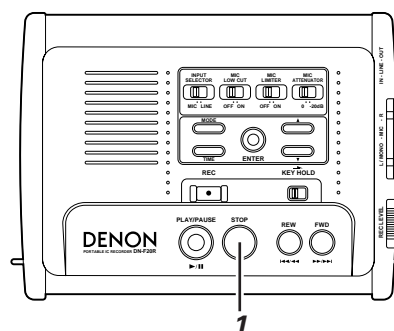

Stopping recording temporarily

- 1** During recording, press the PLAY/PAUSE button.
- Recording is paused.



[Recording pause]

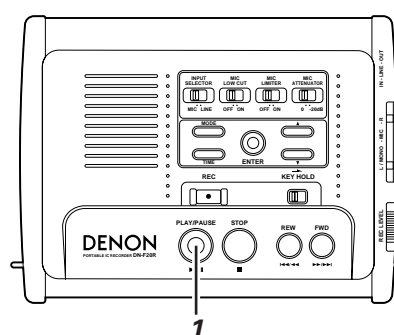

- ※ **To resume recording from the position at which it was paused**, press the PLAY/PAUSE button again.
- ※ **When the REC button is pressed while in the recording pause mode**, the file name is incremented and recording resumes.

Cautions on recording

- The maximum number of files that can be recorded in a single directory is 999.
- The files are automatically given names (numbers) one number above the highest file number in the current directory. Because of this, it is no longer possible to record in a directory if there is a file named "x999.mpg" (or "x999.wav") in that directory, even if there are fewer than 999 files in the directory. If this happens, either change the file name or move to a different directory.
- When the REC button is pressed, the file name (number) is incremented to one number above the current file's name. File names above x999 are not incremented.
- With relay recording, the relay operation is given priority when switching slots, so buttons may not work temporarily while switching slots.
- The auto power off function does not work in the recording or recording pause mode. Be careful with the batteries. Recording consumes much battery power. We recommend stopping or turning off the power whenever possible.
- The monitor speaker is turned off in the record and record pause modes. (The input signal can be monitored over the headphones or LINE OUT.)
- If "REC FORM" is set to "MONO" in the preset mode, only the input from L channel is effective.

9 EDITING AND ERASING FILES

- Recorded file names can be changed, and files can be divided.
- Recorded files you do not need can be erased.
- Memory cards can be formatted for use on the DN-F20R.

Changing file names

- 1** Select the file to be edited.
- Select the file. (See page 16.)

- 2** In the stop mode, press the MODE button.
- The preset mode is set.

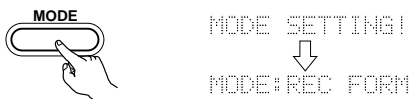

- 3** Select the file name editing mode.
- Press the ▼ button to display "MODE:FILE NAME EDIT".



- 4** Press the ENTER button.
- The file name change mode is set.

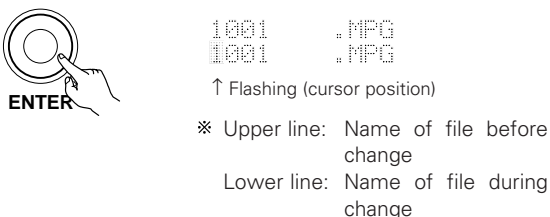

- 5** Input the new file name.
- Use the FWD and REW buttons to select the character (letter or symbol) to be input.

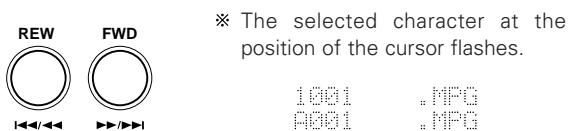

- The characters (letters and symbols) shown below can be used for file names. The displayed character changes in order each time the FWD or REW button is pressed.

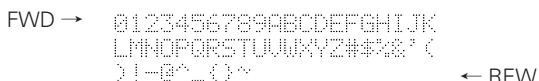

- 6** Move the cursor to the next position.
- When the button is pressed, the cursor moves to the right.

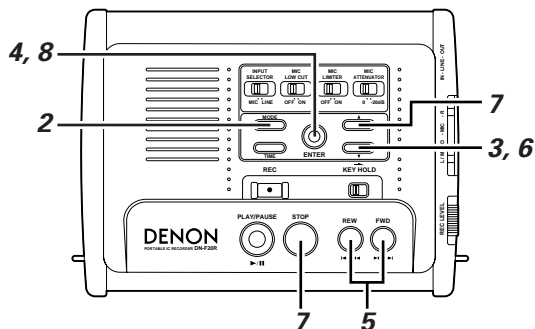
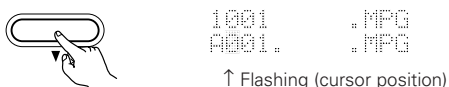

- 7** Repeat steps 5 and 6 to input the new file name.
- The file name can contain up to 8 characters.
 - Press the ▲ button to move the cursor back to the left.

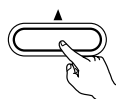

- When the STOP button is pressed, the character at the cursor position is cleared.

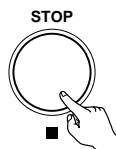

- When the STOP button pressed while selecting characters, the character currently being selected is cleared and the character that was set before a new character was selected reappears.

- 8** Press the ENTER button.
- The changed file name is entered and the preset mode is canceled.



- If the file name has been cleared or if there is already another file with that name in that directory, "CAN'T NAME CHANGE" is displayed for 2 seconds and the file name change mode is canceled.

Dividing files

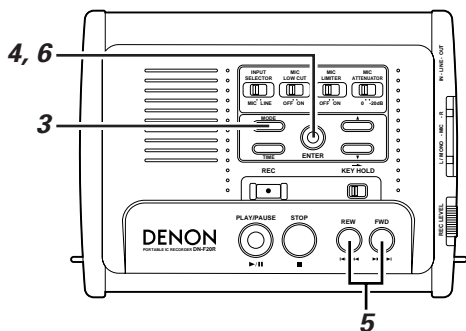

- 1** Select the file to be divided.
 - Select the file. (See page 16.)
- 2** Find the position at which you want to divide the file.
 - Use the manual search function (see page 17) to find the position at which you want to divide the file, then set the pause mode at that position.

```
DIR1\1001
00h15m47s 03/03 15:03
```

- 3** In the pause mode, press the MODE button.
 - The file dividing mode is set.

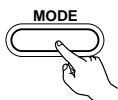

```
MODE
DIVIDE?
```

- 4** Press the ENTER button.
 - A 4-second section of the file starting from the position at which the pause mode is set is played repeatedly.



```
Flashing
DIVIDE          ±0
00h15m47s01
```

- 5** If you want to change the file divide position:
 - Use the FWD and REW buttons to move the position. The 4-second section is played repeatedly.

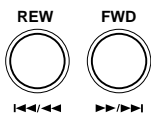

※ The divide position moves forward when the FWD button is pressed, backward when the REW button is pressed.

- When the button is pressed, the position moves forward or backward by 0.048 seconds (for a sampling frequency of 24 kHz).
 - ※ When the sampling frequency is set to 48 kHz, the position moves by 0.024 seconds.
- The position can be moved ±255 steps.

- 6** Press the ENTER button.
 - The divide position is entered.



※ The set returns to the pause mode after dividing is completed.

Erasing files

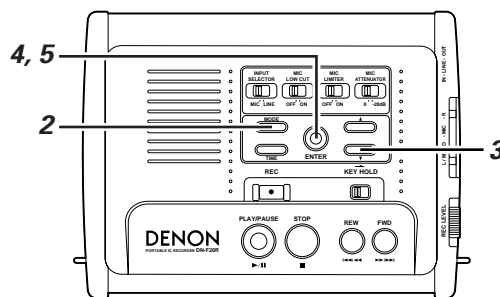

- 1** Select the file to be erased.
 - Select the file. (See page 16.)
- 2** In the stop mode, press the MODE button.
 - The preset mode is set.

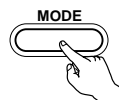

```
MODE SETTING!
MODE:REC FORM
```

- 3** Select the file erase mode.
 - Press the ▼ button to display "MODE:FILE ERASE".

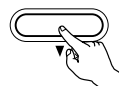

```
MODE:FILE ERASE
1001.MPG
Name of file to be erased
```

- 4** Press the ENTER button.
 - The file erase mode is set.



```
MODE:FILE ERASE
1001.MPG ERASE?
```

- 5** Press the ENTER button.
 - The file is erased and the preset mode is canceled.



※ Press the MODE button if you do not want to erase the file.

Precautions concerning file division

- When a file is divided, the first file keeps the current file name, and the second file is given a name (number) one number above the highest file number in the current directory.
- If the MODE button is pressed before pressing the ENTER button to divide the file, the divide mode is canceled and the stop mode is set.
- When the STOP button is pressed while the 4-second section is being played repeatedly, the divide mode is canceled.
- It may not be possible to divide a file if the size of the divided file is too small or if there is not enough space left on the card.

Erasing all the files in a directory

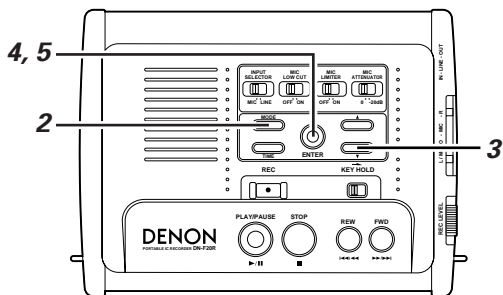

- 1** Select the directory whose files you want to erase.
- Select the directory. (See page 16.)

- 2** In the stop mode, press the MODE button.
- The preset mode is set.



- 3** Select the directory erase mode.
- Press the ▼ button to display "MODE:DIR ERASE".

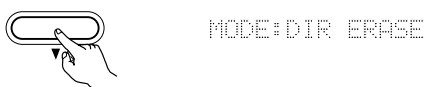

- 4** Press the ENTER button.
- The file erase mode is set.



- 5** Press the ENTER button.
- All the files in the directory are erased and the preset mode is canceled.

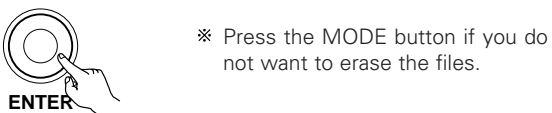

Cautions on file editing operations

- The DN-F20R stores files in DOS format. Because of this, files cannot be given the following names, which are reserved for DOS: CON, AUX, COM1, COM2, COM3, COM4, LPT1, LPT2, LPT3, PRN, NUL.
- The DN-F20R is compatible with DOS 8.3 formats (file names of up to 8 capital letters, period, extensions of up to 3 capital letters). It does not support small letters or the long file names available for Windows 95™ (*1) or later. When creating files or changing file names on a Windows 95™ (*1) system, do not use small letters in the file names or extensions or use files names consisting of more than 8 letters or extensions with more than 3 letters.

(*1) Windows 95™ is a registered trademark of the Microsoft Corporation.

Reformatting memory cards

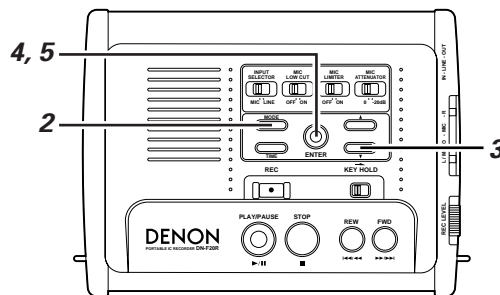

- 1** Insert the card to be formatted in the card slot.
- Be sure to insert the card in the proper direction. (See page 9.)
 - When 2 cards have been inserted, use the CARD button to select the card that is to be formatted. (See page 27.)

- 2** In the stop mode, press the MODE button.
- The preset mode is set.



- 3** Select the card format mode.
- Press the ▼ button to display "MODE:CARD FORMAT".



- 4** Press the ENTER button.
- The card format mode is set.



- 5** Press the ENTER button.
- The card is reformatted and the preset mode is canceled.

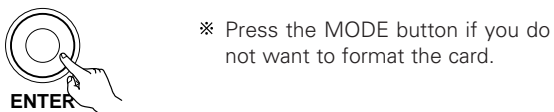

10 OTHER OPERATIONS

Checking the date and time

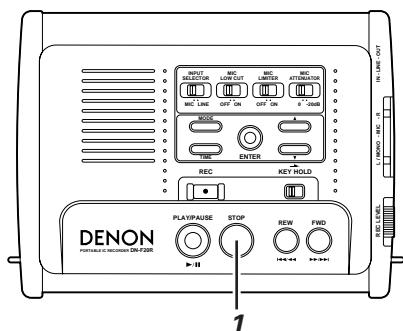

- 1** In the stop mode, press the STOP button.
- The current date and time are displayed for 5 seconds.

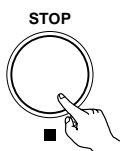

※ A simultaneous display of the FILE SORT order, which was set with the preset mode setting, is provided.

Switching the time display

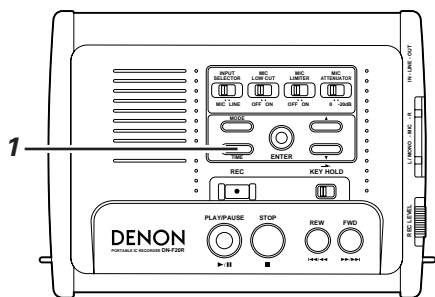

- 1** Press the TIME button.
- The time display switches between the elapsed time ("TOTAL") and remaining time ("REMAIN") each time the button is pressed.

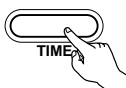

※ Please see "Audio file time displays" below for details of the display contents.

Switching the current card



- 1** Press the CARD button.
- The current card switches between "SLOT1" and "SLOT2" each time the button is pressed.

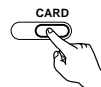

※ It is not possible to switch the current card unless cards are loaded in both slots.

Turning on the back light



- 1** Press the LIGHT button.
- The display's back light turns on. The back light turns off automatically once the preset time is up.

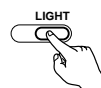

※ The back light also lights when buttons are operated.

- If "BACK LIGHT TIMER" is set to "CONTINUOUS" in the preset mode (see page 10), press the LIGHT button again to turn off the back light.

Audio file time displays

	TOTAL time display	REMAIN time display
Stop mode (STOP)	Total time of current file ※ Not displayed if there is no file	Remaining time on card calculated according to the currently set recording mode and recording bit rate
Play and pause modes (PLAY/PAUSE)	Elapsed time of current file	Remaining time of current file
Recording and recording pause modes (REC and REC PAUSE)	Elapsed time of file currently being recorded	Remaining time on card calculated according to the currently set recording mode and recording bit rate

Creating index files

The DN-F20R is equipped with a function for creating and storing separate files, listing the audio files on the IC memory card. This function comes in handy for creating tables of the audio files recorded on IC memory cards using spreadsheet programs on PC systems, etc.

With the DN-F20R, these files are called "index files".

Index files are stored in CVS format. They include the directory names, file names, file recording dates, file sizes, etc.

- 1** In the stop mode, press the MODE button.
- The preset mode is set.

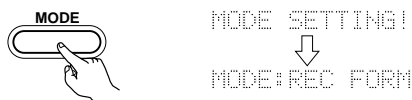

- 2** Select the index file create mode.
- Press the ▼ button to display "INDEX FILE MAKE".

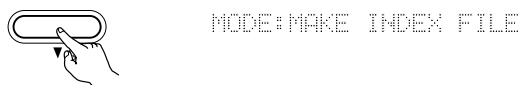

- 3** Press the ENTER button.
- A message for confirming that you want to make an index file for the card in the current slot appears.



- 4** Press the ENTER button.
- The index file is created and the stop mode is set.

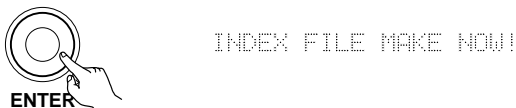

- * Press the MODE button if you do not want to make the index file.

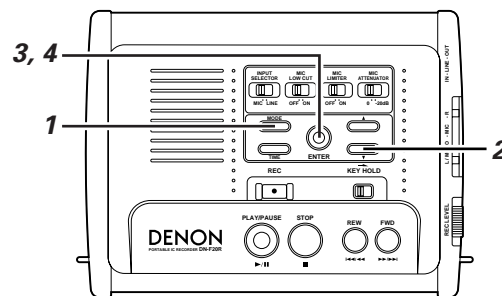

Notes

- It is not possible to view the index file or its contents on the DN-F20R.
- Files recorded or deleted after creating the index file are not reflected in the index. If you wish to reflect these files, create a new index file.
- Index files can only be created for audio files located within the standard DN-F20R IC memory card directories.
- The index file is only created for the card in the current slot. To create index files for the cards in both slots, first create an index file for one card, then use the CARD button to switch the current slot and create an index file for the other card.
- It may not be possible to create index files if there is not enough space left on the card or if there is a card error.
- If there are many audio files, it may take 30 seconds or more to create the index file. Never turn the power off or remove the card while the index file is being created.

11 TROUBLESHOOTING

Messages

The following lists and describes the main messages shown on the character display during various operations.

Warning message (n*1 = 1, 2, 1&2)	Description
OFF PLEASE WAIT!	This is displayed while the power is being turned off, then clears once the power turns off. ※ Never unplug the AC adaptor or remove the batteries while this message is displayed.
SLOTn*1: CARD CHECK NOW!	This is displayed while the card is being checked. ※ Never eject the card while this message is displayed.
CAN'T NAME CHANGE!	The file name cannot be changed to the file name you have set. ※ This is displayed when a file with the same name already exists.
DOS RESERVED NAME!	The file name cannot be changed to the file name you have set. ※ This is displayed when a name reserved for DOS or an otherwise improper name is set.
CAN'T REC PAUSE!	The recording pause mode cannot be set. ※ This is displayed when the recording pause mode cannot be set, for example during the relay operation or directly after recording starts.
DIR END!	End of directories (there are no more directories in the direction in which you are trying to move).
DIRn*2 \NO FILE! (n*2 = 0 ~ 9)	There are no files in the current directory (one of directories 0 to 9).
FILE END!	End or beginning of files. ※ This is displayed when there are no more files in the direction in which you are trying to move during file searching, etc.
INDEX FILE MAKE NOW!	This is displayed while an index for the card in the current slot is being created. ※ Never eject the card while this message is displayed.
SLOTn*1: NO CARD!	There is no card in that slot.
SLOTn*1: FILE FULL!	The current directory on the card in that slot already contains the maximum number of files.
SLOTn*1: CARD FULL!	The card in that slot is already full to capacity.
SLOTn*1: DIR CHANGE!	Change the directory for that slot.
UNDIVIDED POINT!	Due to system restrictions, it is not possible to divide the file at that point.
DIFFERENT CARD CAN'T 1&2 REC!	Double recording is not possible because the cards are of different types or formats or have different cluster sizes.

Error messages

If there is an error while using the set, an error message consisting of a number (ERROR = (error number)) appears on the display. This number indicates the type of error.

The error numbers are 4-digit numbers. Their meanings are described below.

If an error arises, it is necessary to take some sort of action, such as turning the power off then back on, formatting the card (note that this will erase any data on the card), replacing the card, etc.

Sometimes the error can be resolved by ejecting the card.

※ The message may differ according to the situation.

Description of errors			
2 left digits		2 right digits	
Error no.	Description	Error no.	Description
01 to 09	Card-related errors	01 to 03, 30 to 59, A0 to B9	Card access errors
10 to 79	Errors arising during operation	04	Directory already contains the maximum number of files
80 to 99	System errors	05	File type error
		06	Card full error
		07	Decoding error
		08 and 09	Data errors
		10 and 70 to 99	Microprocessor errors
		11 and 12	File over errors
		60 to 69	Memory card errors
		C0 to E9	Memory card format errors
Specific 4-digit errors			
Error no.	Description		
0304	Standard DN-F20R directories cannot be created. If many files and directories (a total of over 255) are stored in the root directory using a PC, etc., the DN-F20R cannot create the directories it requires. If this happens, reduce the number of files using a PC, etc.		
0411 and 0412	An error is generated when: <ul style="list-style-type: none"> • there are 1000 or more audio files in the current directory of that card. • there are a total of over 1023 files, including non-audio files. If this happens, reduce the number of files using a PC, etc.		
xx05	File type error. (xx = any numbers) The FAT or specific files on the card are damaged. Either erase the files or reformat the card.		
2506	The index file cannot be created due to insufficient card space. Make extra space by erasing some files, etc.		
8810	The card has been ejected while it was being accessed. If this message appears each time the power is turned on, the card is damaged. Reformat the card. Note that in some cases the card becomes unusable when this error is generated.		

Before assuming there is a malfunction

Check the following before assuming there is a malfunction with the set.

When a pertinent item cannot be found in this table, the problem may be due to a fault with this unit. Switch off the power, disconnect the power plug from the outlet, remove the batteries, and contact your store of purchase.

Symptom	Possible cause/things to check	Solution
Power does not turn on.	• Batteries are worn.	• Replace the batteries.
	• AC adaptor is not securely connected.	• Check the connection.
	• Power has been turned off with the auto power off	• Press the power switch again.
Buttons do not operate.	• Power is off.	• Turn the power back on.
	• KEY HOLD switch is turned on.	• Turn the KEY HOLD switch off.
	• Card has been ejected while it was being accessed.	• Turn the power off then back on.
Card error message is displayed.	• Card is not of the recommended type.	• Use a card of the recommended type.
	• Format is not compatible. • Card data is damaged.	• Format the card on the DN-F20R.
	• File is damaged.	• Either format the card on the DN-F20R (note that this will erase any data on the card) or erase the file using a PC, etc.
Current file cannot be played.	• File format is not compatible with the DN-F20R. ※ Files with bit rates or compression/decompression formats other than the ones usable on the DN-F20R cannot be played, even if they have the extension "MPG" or "WAV".	_____
	• File is too small. ※ It may not be possible to play short files.	_____
Recording is not possible.	• Card is not of the recommended type.	• Use a card of the recommended type.
	• Other cause.	• Check the notes in the "Recording" section once again.
Linear PCM recording is not possible.	• In some cases Linear PCM recording is not possible due insufficient speed of the card itself.	• Change the presetting to "MPEG". • Use a different card.
Power turns off during recording.	• Batteries are worn. ※ The power turns off automatically several minutes after the battery warning mark appears.	• Replace the batteries.
Sound of microphone cannot be recorded.	• INPUT SELECTOR switch is set to "LINE".	• Set the INPUT SELECTOR switch to "MIC".
	• REC LEVEL control is set to the minimum.	• Raise the recording level.
	• The microphone is not properly connected.	• Connect the microphone properly.
No sound is produced from speaker.	• Recording or recording pause mode is set. ※ The speaker is turned off while in record and record pause modes.	_____
	• MONITOR VOL. control is set to the minimum.	• Raise the monitor volume.

12 PARALLEL REMOTE JACK

The DN-F20R is equipped with a parallel remote jack.

Denon does not offer any optional products for use with this parallel remote jack.

Below is a circuit diagram for reference purposes.

NOTES:

- Denon accepts no responsibility whatsoever for any damages or infringements of patents or other rights resulting from the use of the circuit below. This does not sanction patents or other rights of Denon or third parties.
- It is strictly forbidden to reprint or reproduce the following circuit diagram in part or in whole.

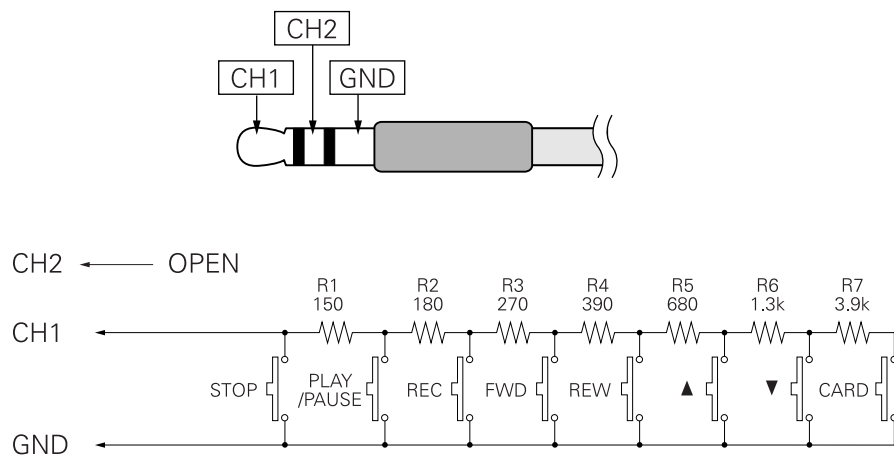

As shown above, it is possible to create the same functions as the buttons on the DN-F20R by using a $\phi 2.5$ plug and external circuit.

- ※ Resistance error – Within 5%.
- ※ Be sure to leave channel 2 open.
- ※ Never apply external voltage. Doing so will result in malfunction.
- ※ Normal operation is not possible when transistors, etc., are used instead of switches due to the circuit resistance.
- ※ Insulate the circuit so that it cannot be touched directly. Use a structure that protects the circuit from static electricity, which will cause malfunction.
- ※ Do not operate the switches at the same time as the buttons on the set.

13 SPECIFICATIONS

Memory cards used	Compact Flash Memory Card (CF Card)/Type 1 (t = 3.3mm)
Audio recording formats	ISO/IEC 11172-3 MPEG1 layer 2 (fs = 48 kHz, 64, 128 kbps/ch) ISO/IEC 13813-3 MPEG2 layer 2 (fs = 24 kHz, 16~64 kbps/ch) Linear (no compression)
Quantization bits	16 bits
Sampling frequencies	48 kHz/24 kHz
Distortion	Below 0.1% (1 kHz, 0dB sine wave playback, using LPF)
S/N ratio	80 dB or more (using LPF and IHF-A filter)
Channel separation	70 dB or more (stereo, 1 kHz, 0dB sine wave playback, using LPF)
Frequency response	20 to 20 kHz : 0 ±3 dB (fs = 48 kHz) 20 to 10 kHz : 0 ±3 dB (fs = 24 kHz)
Inputs	Microphone input : -68 dBm (0.3 mV) Line input : -13 dBm (180 mV)
Outputs	Line output : 1.4 Vrms (10 kΩ/ohms : 1 kHz, 0 dB) Headphones output : 1.0 Vrms (33 Ω/ohms : 1 kHz, -6 dB)
Continuous recording time	Approx. 4 hours (using alkaline batteries, normal recording with one CF card)
External dimensions	210 mm (width) x 45 mm (height) x 161 mm (depth) (8-17/64" x 1-49/64" x 6-11/32")
Mass	800 g (main unit only) (not including IC memory cards or batteries) (1 lbs 12 oz)
Power supply	Batteries : LR6 (AA size) alkaline battery x 6 AC adaptor (AA-24) : Input AC 120V, 60 Hz (North America model) Input AC 230V, 50 Hz (Europe and Asia model) Input AC 240V, 50Hz (U.K. model)
Current consumption	DC 7V 400 mA : During recording (back light off) with AC adaptor AA-24
Environmental conditions	Surrounding temperature during operation : 5 to 35°C Surrounding humidity during operation : 40 to 80% (no condensation) Surrounding temperature during storage : -20 to 60°C Surrounding humidity during operation : 20 to 90% (no condensation)

* For purposes of improvement, specifications and design are subject to change without notice.

DENON SERVICE NETWORK/ 服務網絡

- Please contact one of our overseas service centers, listed below, for follow-up service consultation.
- Wenden Sie sich für anfallende Wartungs- bzw. Reparaturarbeiten bitte an eine der folgenden aufgeführten Kundendienststellen.
- Adressez-vous à nos centres de service d'outre-mer indiqués ci-dessous, pour le service après-vente.
- Per il servizio dopo vendita rivolgete Vi al nostro centro di servizio estero appropriato della lista seguente.
- Para consultas de servicio por favor diríjase a cualquiera de nuestros centros de servicio en el extranjero, enlistados abajo.
- Neem kontakt op met één van onze reparatie-inrichtingen in het buitenland, waarvan hier een lijst volgt, voor na-service.
- Ta kontakt med nedan angivna servicecentraler för rådfrågning om servicearbeten efter försäljningen.
- Favor contactar um de nossos centros de serviços internacionais, abaixo listados, para consulta de serviços de acompanhamento.
- 請據下表所列本公司海外服務中心查詢售後服務事宜。

Australia	AWA Audio Products Pty Ltd. 67 O'Riordan Street, Alexandria NSW 2015, Australia Tel: (02) 9669-3477 Fax: (02) 9578-0140
Austria	Digital-Professional-Audio Vertriebsges.m.b.H., 1170 Wien, Rupertusplatz 3 Tel: 0222-4501006~9, Fax: 0222-457679
Belgium	Transtel-Sabima P.V.B.A. Harmoniestraat 13, 2018 Antwerpen 1, België Tel: 03-237-3607
Canada	Denon Canada Inc. 17 Denison Street, Markham Ontario, Canada L3R 1B5 Tel: 905-475-4085 Fax: 905-475-4159
China	Shanghai Denon Products Service Co., Ltd. Room 1504, A Building 527 Huaihai Zhong Road, Shanghai 200020, P.R.C. Tel: 86-21-5306-2078 Fax: 86-21-5306-0620 中國遠望機電技術發展中心(北京天龍特約維修中心)北京東直門內大街92號 郵編: 100007 電話: (10) 64015151/64023798 傳真: (10) 64034229 天龍音響上海特約技術維修服務中心 上海金沙江路253號 郵編: 200062 電話: 86-21-6257-9958 傳真: 86-21-6260-5645
Czecho	EUROSTAR OSTORAVA s.r.o. areal Vodni stavby Praha a.s., budova A2 Dobronicka 635, 148 00 Praha 4 Czech Rep. Tel: 02-6111-2901 Fax: 02-6111-2904
Denmark	Hifi Klubben A/S Dali Alle 1, 9610 Noerager, Denmark Tel: 45-96 72 10 00 Fax: 45-96 72 10 14
Finland	Suomen Hi-Fi Klubi OY Nylandsgatan 4-6, Helsingfors Tel: 0644401
France	Denon France S.A. 3 Boulevard Ney, 75018 Paris Tel: 44-89-68-69
F.R. Germany	Denon Electronic GmbH An der Landwehr 19, 41334 Nettetal Tel: +49 2157 12 08 78 Fax: +49 2157 12 08 13
Greece	KINOTECHNIKI LTD. 14, PYRGOU STR. 166 75, GLYFADA ATHENS Tel: 01-96-01-071 Fax: 01-96-01-72
Hong Kong	DENON ASIA COMPANY LTD. 18/F No.79 Chatham Road South, Tsimshatsui Kowloon, Hong Kong Tel: 852-2516-6862, Fax: 852-2516-5940 天龍音響(亞洲)有限公司 香港九龍尖沙咀漆咸道南七十九號十八樓 電話: 852-2516-6862 傳真: 852-2516-5940
Hungary	InfoVox Ltd. Terez krt. 31, 1067 Budapest Hungary Tel / Fax: 01-302-2515
Iceland	Japis Ltd. Brautarholt 2, P.O.Box 396, 121 Reykjavik, Iceland Tel: 354-58009-800 Fax: 354-5800-888
Indonesia	PT Autoaccindo Jaya. Cideng Barat No. 7 Jakarta, Indonesia Tel: 633-2730
Italy	Audiodelta S.r.l. 19 Via Pietro Calvi 20129 Milan Italy Tel: 39-02-5411-6008 / 39-02-5412-8253 Fax: 39-02-5518-1961
Korea	DAIYOUNG Industrial Co., Ltd. 1027-5, Bangbae-dong, Seocho-gu, Seoul 137-060 Korea Tel: 82-2-588-3960 Fax: 82-2-586-3721
Malaysia	HWEE SENG (ELECTRONICS) SDN BHD. 13-1, Jalan Raja Laut, 50350 Kuala Lumpur Malaysia Tel: 60-3443-1193 Fax: 60-3441-0563
Mexico	Labrador, S.A. de C.V. Zamora No. 154 Col. Condesa 06140 Mexico, D.F. Tel: 286 55 09 Fax: 286 34 62
Netherlands	Penhold B.V. Poppenbouwing 58, NL-4191 NZ Geldermalsen, Netherland Tel: 31-345-588 080 Fax: 31-345-588 085
New Zealand	Avalon Audio Corpn. Limited 630B Great South Road Ellerslie Auckland, New Zealand Tel: 64-9-579-1280 Fax: 64-9-579-3350
Norway	Hi-Fi Klubben AS Sandakerveien 64 0483 Oslo Tel: 47 22 79 66 66 Fax: 47 22 79 66 67
Poland	HORN DISTRIBUTION S.A. Ulica Kurantow 34, 02-873 Warszawa Poland Tel: +48 22 649 30 71 Fax: +48 22 649 31 99
Portugal	Videocustica Qta. Do Paizinho-Armazém 5-Estrada De Circunvalação-Apart. 3127 1303 Lisboa Codex Tel: (01)417-00-04/00-96 Fax: (01)418-80-93
Singapore	Hwee Seng (Electronics) Pte Ltd. 81 Genting Lane #02-02, Everich Industrial Building Singapore 349566 Tel: 65-746-3355 Fax: 65-743-1704
South Africa	TELEMEDIA (PTY) LTD 17 Ninth Avenue, Rivonia Sandton 2146, P.O.BOX 783515 Republic of South Africa Tel: (011)803 3353/4 Fax: (011)803-2534
Spain	Gaplasa S.A.AV. Ing. Conde de Torroja, 25, 28022 Madrid Tel: 91-329-29-60 Fax: 91-329-16-75
Sweden	Sveriges Hi-Fi Klubb Box 5116, S-402 23 Göteborg Tel: 031-200040
Switzerland	Diethelm & Co., AG. Grindelstrasse 5, 8303 Bassersdorf Tel: 01-306-1611 Fax: 01-306-1690
Taiwan R.O.C.	Taiwan Kolin Co., Ltd. 10th Fl., 86, Sec. 1, Chung-king S. Rd., Taipei, Taiwan R.O.C. Tel: 886-2-2314-1459 Fax: 886-2-2314-8521
進口廠商	KOLIN歌林股份有限公司 台北市重慶南路一段86號10樓 電話: 886-2-2314-1459 傳真: 886-2-2314-8521
Thailand	Mahajak Development Co., Ltd. 46 Mahajak Building, Sukhumvit Soi 3 (Nana-Nua) Klongtoey, Bangkok Thailand. 10110 Tel: 66-2-256-0020 Fax: 66-2-253-1696
United Kingdom & Eire	Hayden Laboratories Ltd. Hayden House, Chiltern Hill, Chalfont St Peter, Gerrards Cross, Bucks, SL9 9UG Tel: 01753-888447 Fax: 01753-880109
U.S.A.	DENON ELECTRONICS, a Division of Denon Corporation (U.S.A.) 222 New Road Parsippany, NJ07054, U.S.A., Tel: 973-396-7499, Fax: 888-544-8434

- * If there is no service center in your local area, consult the outlet where the equipment was purchased.
- * Falls sich in Ihrer Nähe keine Kundendienststelle befindet, wenden Sie sich an das Geschäft, wo das Gerät gekauft wurde.
- * S'il n'y a aucun centre de service dans votre région, consultez votre revendeur.
- * Se nella Vostra zona non c'è il centro di servizio, rivolgete Vi al negozio dove avete acquistato l'apparecchio.
- * Si no hay centros de servicio en su área local, consulte en donde haya comprado su equipo.
- * Als er in uw streek geen reparatie-inrichting is, neemt u contact op met de vestiging waar u de apparatuur gekocht heeft.
- * Saknas servicecentral i närheten där du bor, bör kontakt tas med återförsäljaren för apparaten.
- * Se não existir um centro de serviços em sua área local, consulte o estabelecimento onde o equipamento foi adquirido.
- * 若當地無服務中心, 可向你購入本機的商號查詢。

NIPPON COLUMBIA CO., LTD.

14-14, AKASAKA 4-CHOME, MINATO-KU, TOKYO 107-8011, JAPAN
Telephone: (03) 3584-8111
Cable: NIPPON COLUMBIA TOKYO Telex: JAPANOLA J22591