

JVC

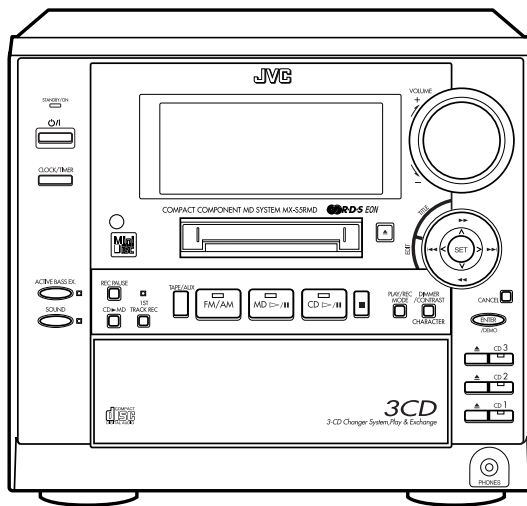

COMPACT COMPONENT MD SYSTEM

CA-MXS5RMD

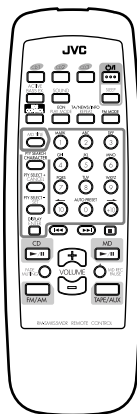

R-D-S EON



**COMPACT
disc**
DIGITAL AUDIO

INSTRUCTIONS

For Customer Use:

Enter below the Model No. and Serial No. which are located either on the rear, bottom or side of the cabinet. Retain this information for future reference.

Model No. _____

Serial No. _____

LVT0354-001A

[B]

Warnings, Cautions and Others

IMPORTANT for the U.K.

DO NOT cut off the mains plug from this equipment. If the plug fitted is not suitable for the power points in your home or the cable is too short to reach a power point, then obtain an appropriate safety approved extension lead or consult your dealer.

BE SURE to replace the fuse only with an identical approved type, as originally fitted.

If nonetheless the mains plug is cut off ensure to remove the fuse and dispose of the plug immediately, to avoid a possible shock hazard by inadvertent connection to the mains supply.

If this product is not supplied fitted with a mains plug then follow the instructions given below:

IMPORTANT:

DO NOT make any connection to the terminal which is marked with the letter E or by the safety earth symbol or coloured green or green-and-yellow.

The wires in the mains lead on this product are coloured in accordance with the following code:

Blue : Neutral
Brown : Live

As these colours may not correspond with the coloured markings identifying the terminals in your plug proceed as follows:

The wire which is coloured blue must be connected to the terminal which is marked with the letter N or coloured black.

The wire which is coloured brown must be connected to the terminal which is marked with the letter L or coloured red.

IF IN DOUBT - CONSULT A COMPETENT ELECTRICIAN.

Caution — switch!

Disconnect the mains plug to shut the power off completely (the STANDBY/ON lamp goes off).

The  switch in any position does not disconnect the mains line.

- When the unit is on standby, the STANDBY/ON lamp lights red.
- When the unit is turned on, the STANDBY/ON lamp lights green.

The power can be remote controlled.

CAUTION

To reduce the risk of electrical shocks, fire, etc.:

1. Do not remove screws, covers or cabinet.
2. Do not expose this appliance to rain or moisture.

REPRODUCTION OF LABELS

① CLASSIFICATION LABEL, PLACED ON REAR ENCLOSURE

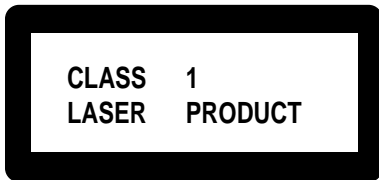

② WARNING LABEL, PLACED INSIDE THE UNIT

DANGER: Invisible laser radiation when open and interlock failed or defeated. AVOID DIRECT EXPOSURE TO BEAM. (e)	WARNING: Osynlig laserstrålning när denna del är öppnad och spärren är urkopplad. Betrakta ej strålen. (s)	ADVARSEL: Usynlig laserstrålning ved åbning, når sikkerhedsafbrydere er ude af funktion. Undgå udsættelse for stråling (d)	VARO: Avattaessa ja suo- jalukitus ohitettaessa olet alttiina näkymättömälle lasersäteilylle. Älä katso säteeseen. (f)
---	---	---	---

1. CLASS 1 LASER PRODUCT
2. **DANGER:** Invisible laser radiation when open and interlock failed or defeated. Avoid direct exposure to beam.
3. **CAUTION:** Do not open the top cover. There are no user serviceable parts inside the Unit; leave all servicing to qualified service personnel.

Caution: Proper Ventilation

To avoid risk of electric shock and fire, and to prevent damage, locate the apparatus as follows:

- 1 Front:
No obstructions and open spacing.
- 2 Sides/ Top/ Back:
No obstructions should be placed in the areas shown by the dimensions below.
- 3 Bottom:
Place on the level surface. Maintain an adequate air path for ventilation by placing on a stand with a height of 10 cm or more.

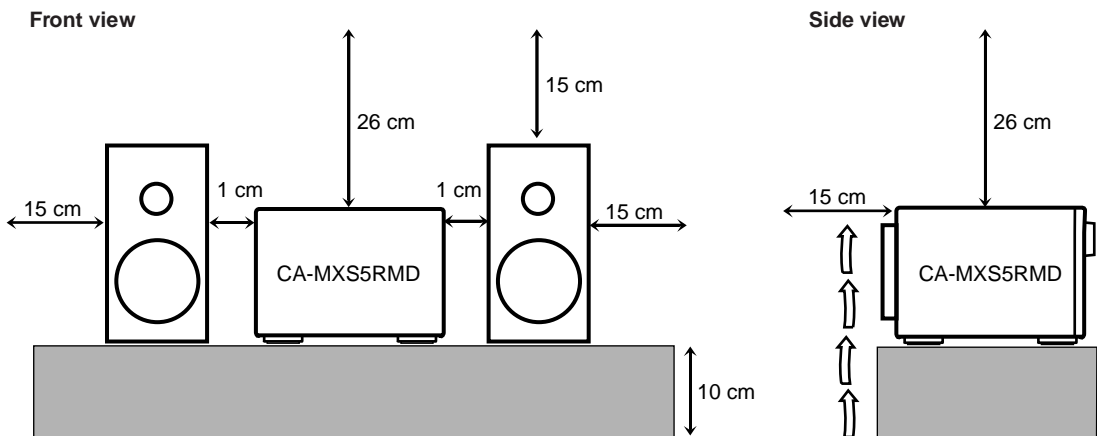

Introduction

We would like to thank you for purchasing one of our JVC products. Before operating this unit, read this manual carefully and thoroughly to obtain the best possible performance from your unit, and retain this manual for future reference.

About This Manual

This manual is organized as follows:

- **The manual mainly explains operations using the buttons and controls on the unit. You can also use the buttons on the remote control if they have the same or similar names (or marks) as those on the unit. If operation using the remote control is different from that using the unit, it is then explained.**
- Basic and common information that is the same for many functions is grouped in one place, and is not repeated in each procedure. For instance, we do not repeat the information about turning on/off the unit, setting the volume, changing the sound effects, and others, which are explained in the section “Basic and Common Operations” on pages 14 – 16.
- The following marks are used in this manual:



Gives you warnings and cautions to prevent from damage or risk of fire/electric shock. Furthermore, gives you information which is not good for obtaining the best possible performance from the unit.



Gives you information and hints you had better know.

Precautions

Installation

- Install in a place which is level, dry and neither too hot nor too cold — between 5°C (41°F) and 35°C (95°F).
- Install the unit in a location with adequate ventilation to prevent internal heat buildup in the unit.
- Leave sufficient distance between the unit and the TV.
- Keep the speakers away from the TV to avoid interference with TV.



DO NOT install the unit in a location near heat sources, or in a place subject to direct sunlight, excessive dust or vibration.

Power sources

- When unplugging the unit from the wall outlet, always pull the plug, not the AC power cord.



DO NOT handle the AC power cord with wet hands.

Moisture condensation

Moisture may condense on the lens inside the unit in the following cases:

- After starting heating in the room
- In a damp room
- If the unit is brought directly from a cold to a warm place

Should this occur, the unit may malfunction. In this case, leave the unit turned on for a few hours until the moisture evaporates, unplug the AC power cord, then plug it in again.

Others

- Should any metallic object or liquid fall into the unit, unplug the unit and consult your dealer before operating any further.
- If you are not going to operate the unit for an extended period of time, unplug the AC power cord from the wall outlet.



DO NOT disassemble the unit since there are no user serviceable parts inside.

If anything goes wrong, unplug the AC power cord and consult your dealer.

Contents

Location of the Buttons and Controls	3	Playing at Random — Random Play	31
Front Panel	4	Repeating Tracks — Repeat Play	31
Remote Control	5	Prohibiting Disc Ejection — Disc Lock	31
Getting Started.....	6	Recording on MDs	32
Unpacking	6	Before You Start Recording	33
Connecting Antennas	6	Recording Any Sound Source	
Connecting Speakers	7	— Standard Recording	34
Connecting Other Equipment	8	Recording CDs	35
Putting the Batteries into the Remote Control	9	Recording FM/AM (LW/MW) Broadcasts	
Basic Settings	10	— Monaural Recording and Stereo	
Turning On the Power	11	Recording	36
Setting the Clock	11	Recording the External Equipment	
Changing the Main Display Screen	12	— Sound Synchronized Recording and Stereo	
Changing the display Brightness and Contrast	13	Recording	36
Basic and Common Operations	14	Editing MDs	38
Selecting the Sources and Starting Play	15	Introducing MD Editing Functions	39
Adjusting the Volume	15	DIVIDE Function	40
Reinforcing the Bass Sound	15	JOIN Function	41
Selecting the Sound Modes	16	MOVE Function	41
Creating Your Own Sound Mode		ERASE Function	42
— MANUAL Mode	16	ALL ERASE Function	43
Listening to FM and AM (MW/LW)		Making Your Own Titles and Screens.....	44
Broadcasts	17	Assigning Titles to an MD	45
Tuning in a Station	18	Creating Your Own Opening and Ending Screens	49
Presetting Stations	18	Using the Timers	50
Tuning in a Preset Station	19	Using Recording Timer	51
Receiving FM Stations with RDS	19	Using Daily Timer	52
Changing the RDS Information	20	Using Sleep Timer	54
Searching for Programs by PTY Codes		Timer Priority	54
(PTY Search)	20	Maintenance	55
Switching to a Program Type of Your Choice		Additional Information	56
Temporarily	21	MD Disc Types	56
Playing Back CDs	24	ATRAC (Adaptive TRansform Acoustic Coding) ..	56
Loading CDs	25	UTO (User Table Of Contents)	56
Playing Back the Entire Discs		SCMS (Serial Copy Management System)	56
— Continuous Play	25	Sound Skip Guard Memory	57
Basic CD Operations	25	MD Messages	58
Programming the Playing Order of the Tracks		Troubleshooting	59
— Program Play	26	Specifications	60
Playing at Random — Random Play	27		
Repeating Tracks or CDs — Repeat Play	27		
Playing Back an MD	28		
Playing Back the Entire MD — Normal Play	29		
Basic MD Operations	29		
Programming the Playing Order of the Tracks —			
Program Play	30		

Location of the Buttons and Controls

Become familiar with the buttons and controls on your unit.

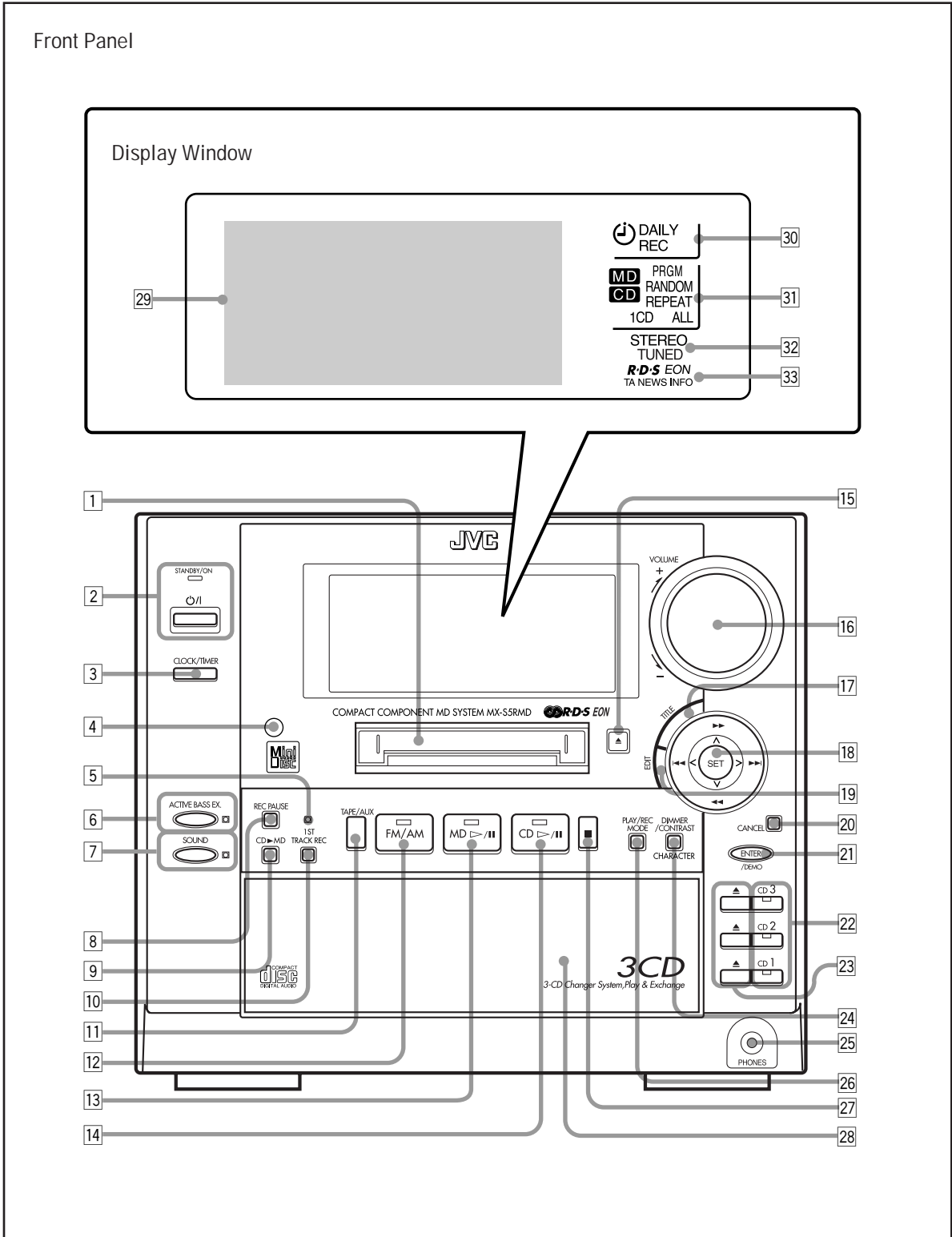

See pages in the parentheses for details.

Front Panel

- 1 MD loading slot
- 2 \odot/I (Standby/On) button and STANDBY/ON lamp (11)
- 3 CLOCK/TIMER button (11, 51)
- 4 Remote sensor
- 5 Recording lamp (34)
- 6 ACTIVE BASS EX. (extension) button and lamp (15)
- 7 SOUND button and lamp (16)
- 8 REC PAUSE button (34)
- 9 CD \blacktriangleright MD button (35)
- 10 1ST TRACK REC button (35)
- 11 TAPE/AUX button (15, 34)
 - Pressing this button also turns on the unit.
- 12 FM/AM button and lamp (15, 18)
 - Pressing this button also turns on the unit.
- 13 MD \triangleright / II (play/pause) button and lamp (15, 29)
 - Pressing this button also turns on the unit.
- 14 CD \triangleright / II (play/pause) button and lamp (15, 25)
 - Pressing this button also turns on the unit.
- 15 MD \blacktriangle (eject) button (29)
 - Pressing this button also turns on the unit.
- 16 VOLUME control (15)
- 17 TITLE button (45, 49)
- 18 Joy control
 - \blacktriangleleft ∇ / \blacktriangleright \wedge / \blacktriangleleft \triangleleft / \blacktriangleright \triangleright , and SET
 - Pressing SET also turns on the unit.
- 19 EDIT button (40)
- 20 CANCEL button (11, 27, 30, 40, 46)
- 21 ENTER/DEMO button (12, 40, 46)
- 22 Disc number buttons and lamps (25)
 - CD 1, CD 2, and CD 3
 - Pressing one of these buttons also turns on the unit.
- 23 CD \blacktriangle (open/close) buttons (25)
 - Pressing one of these buttons also turns on the unit.

- 24 DIMMER/CONTRAST button (13)
- CHARACTER button (45)
- 25 PHONES jack (15)
- 26 PLAY/REC MODE button (26, 30, 36, 37)
- 27 \blacksquare (stop) button (25, 29, 34)
- 28 Disc trays (25)

Display window

- 29 Main display
 - Shows the source name, track number, and other information.
- 30 Timer mode indicators
 - \odot , DAILY (Daily Timer) and REC (Recording Timer)
- 31 MD/CD play mode indicators
 - MD, CD, PRGM (Program), RANDOM, and REPEAT (1/CD/ALL)
- 32 Tuner mode indicators
 - STEREO and TUNED
- 33 RDS operation indicators
 - RDS, EON, and TA/NEWS/INFO

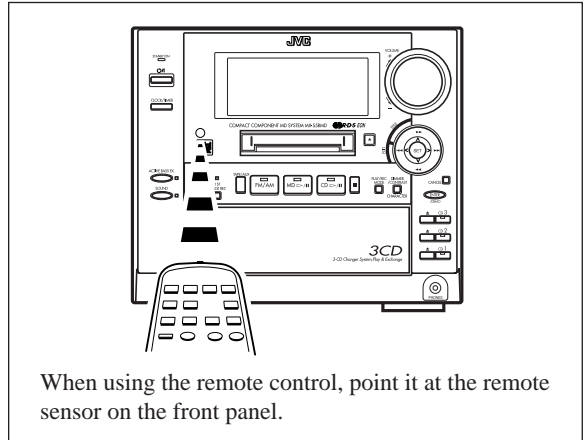

When using the remote control, point it at the remote sensor on the front panel.

About the indications in the main display

When using some functions with the remote control, the indications in the main display appear differently at first from those when using the same functions with the buttons on the unit.

Ex. When selecting a CD track using the remote control

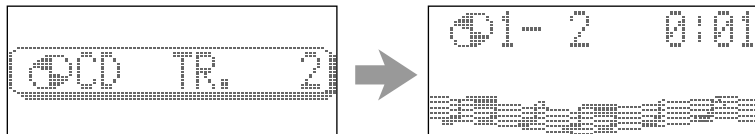

This indication does not appear when using the buttons on the unit except the TAPE/AUX, FM/AM, MD \triangleright / II , CD \triangleright / II , TITLE, and EDIT buttons.

Remote Control

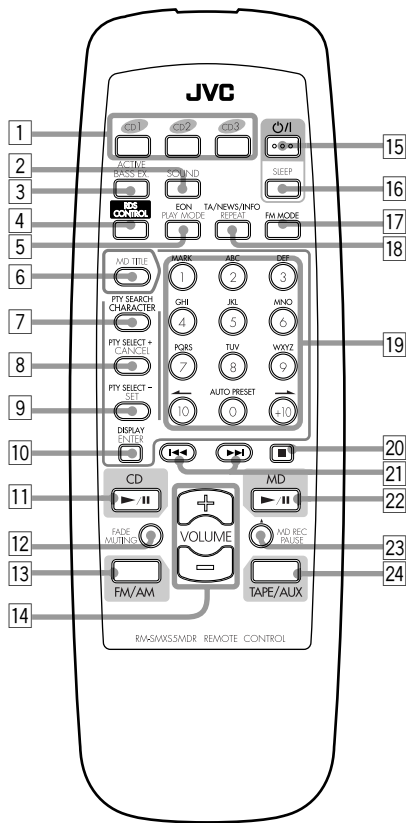

Remote Control

- 1 Disc number buttons (25)
 - CD 1, CD 2, and CD 3

Pressing one of these buttons also turns on the unit.
- 2 SOUND button (16)
- 3 ACTIVE BASS EX. (extension) button (15)
- 4 RDS CONTROL button (20)
- 5* PLAY MODE button (26, 30)
EON button (21)
- 6 MD TITLE button (47)
- 7* CHARACTER button (48)
PTY SEARCH button (20)
- 8* CANCEL button (27, 30, 48)
PTY SELECT + button (20)
- 9* SET button (48)
PTY SELECT – button (20)
- 10* ENTER button (48)
DISPLAY button (20)
- 11 CD ► / || (play/pause) button (15, 25)
 - Pressing this button also turns on the unit.
- 12 FADE MUTING button (15)
- 13 FM/AM button (15, 18)
 - Pressing this button also turns on the unit.
- 14 VOLUME + / – button (15)
- 15 ⏻ / ⏻ (Standby/On) button (11)
- 16 SLEEP button (54)
- 17 FM MODE button (18)
- 18* REPEAT button (27, 31)
TA/NEWS/INFO button (21)
- 19* Number buttons
 - 1 – 10, +10 buttons (19, 26, 29)
 - Character entry buttons (A – Z, 0 – 9) (48)
 - ◀ / ▶ buttons (48)
 - AUTO PRESET button (18)
- 20 ■ (stop) button (25, 29, 34)
- 21 ◀◀ / ▶▶ (reverse search/forward search) button
(18, 26, 27, 29)
- 22 MD ► / || (play/pause) button (15, 29)
 - Pressing this button also turns on the unit.
- 23 MD REC PAUSE button (34)
- 24 TAPE/AUX button (15, 34)
 - Pressing this button also turns on the unit.

* When using the remote control:

For RDS operations, press RDS CONTROL on the remote control first when using the buttons (5), (7), (8), (9), (10) and (18).

For entering MD titles, press MD TITLE on the remote control first when using the buttons (7), (8), (9), (10), (19).

- After entering titles, make sure to change the operation mode of the remote control to the one you want to use by pressing CD ► / || (11), FM/AM (13), MD ► / || (22), or TAPE/AUX (24).

Unpacking

After unpacking, check to be sure that you have all the following items.

The number in the parentheses indicates the quantity of the pieces supplied.

- AM loop antenna (1)
- FM antenna (1)
- Remote control (1)
- Batteries (2)

If any is missing, consult your dealer immediately.

Connecting Antennas

FM antenna

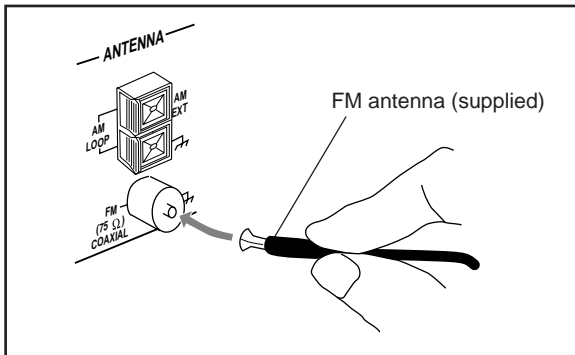

- 1 Attach the FM antenna to the FM (75 Ω) COAXIAL terminal.**
- 2 Extend the FM antenna.**
- 3 Fasten it up in the position which gives you the best reception.**



About the supplied FM antenna

The FM antenna supplied with this unit can be used as temporary measure. If reception is poor, you can connect an outdoor FM antenna.

To connect an outdoor FM antenna

Before connecting it, disconnect the supplied FM antenna.

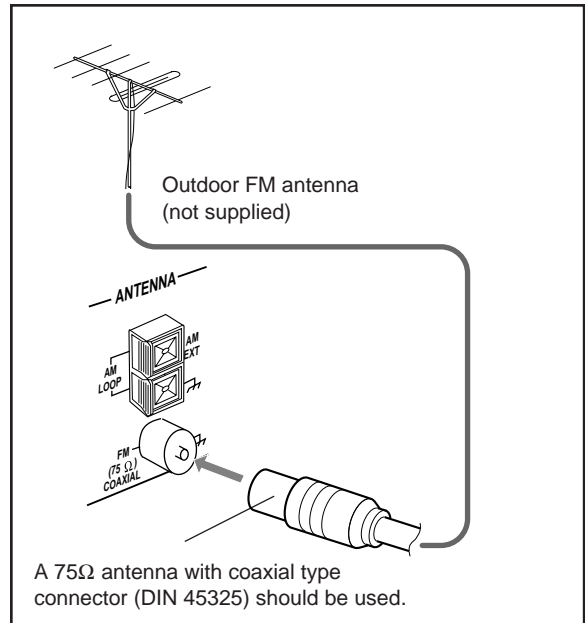

AM antenna

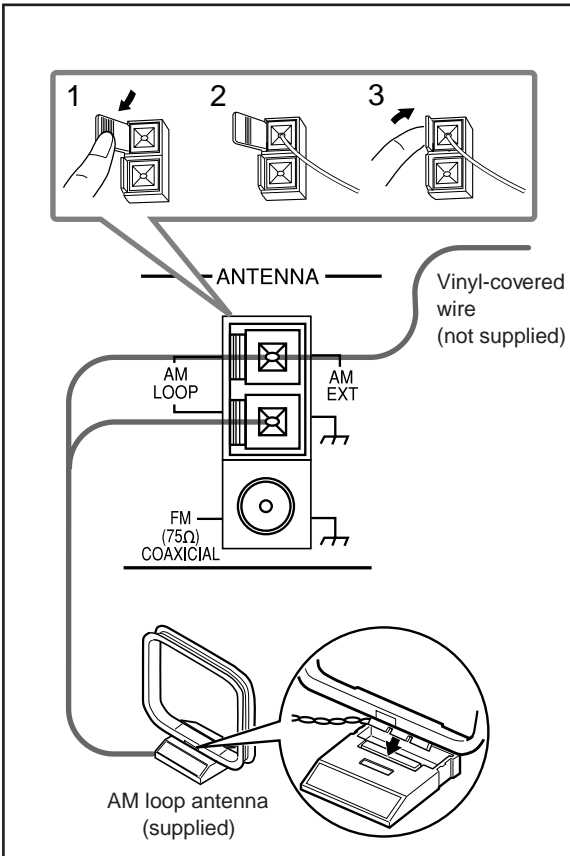

- 1 Connect the AM loop antenna to the AM LOOP terminals as illustrated.
- 2 Turn the AM loop antenna until you have the best reception.

To connect an outdoor AM antenna

When reception is poor, connect a single vinyl-covered wire to the AM EXT terminal and extend it horizontally. (The AM loop antenna must remain connected.)



For better reception of both FM and AM (MW/LW)

- Make sure the antenna conductors do not touch any other terminals and connecting cords.
- Keep the antennas away from metallic parts of the unit, connecting cords, and the AC power cord.

Connecting Speakers

You can connect the speakers using the speaker cords.

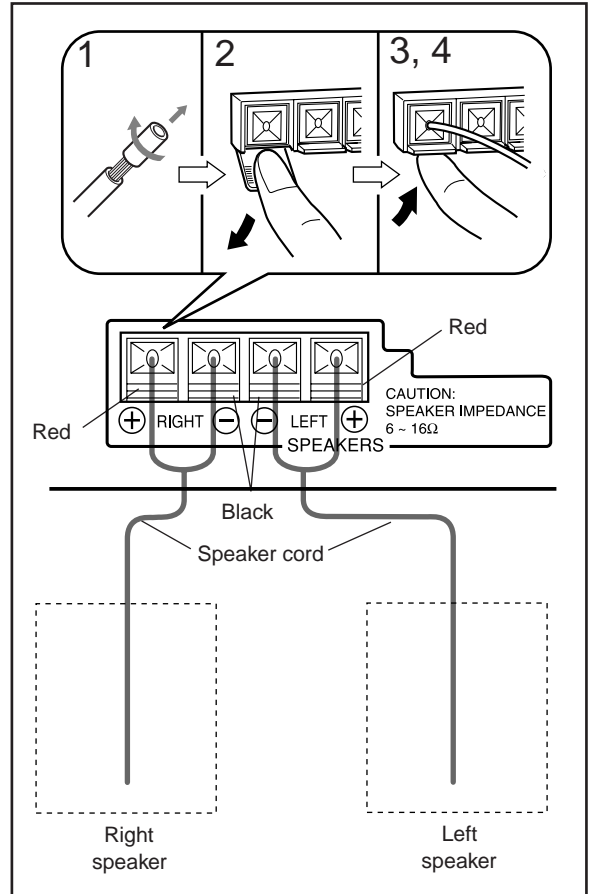

- 1 Twist the core of the cord at the end of each cord, then remove the insulation.
- 2 Open the speaker terminal.
- 3 Insert the end of the speaker cord to the terminal. Match the polarity of the speaker terminals: Red (+) to red (+) and black (-) to black (-).
- 4 Close the speaker terminal on the rear of the unit.

Use only speakers with the same speaker impedance as indicated by the speaker terminals on the rear of the unit.

Connecting Other Equipment

You can connect the following equipment to this unit:

- **Cassette deck** — used as a playback and recording device. By using the cassette deck, you can record any source played back on this unit.
- **Audio equipment with an optical digital output terminal** — used only as a digital playback device.

When you connect and use these equipment, refer also to the manuals supplied with them.

Be sure that the plugs of the audio cords and the jacks on the rear of the unit are color coded: White plugs and jacks are for left audio signals, and red ones for right audio signals.



- **DO NOT** connect other equipment while the power is on.
- **DO NOT** plug in any equipment until all connections are complete.

To connect a cassette deck

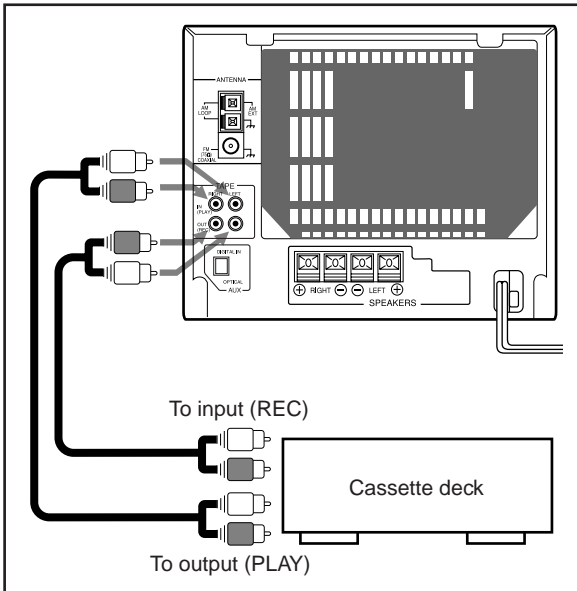

By using audio cords (not supplied), connect:

- Between the audio input jacks on the cassette deck and the TAPE OUT (REC) jacks — For recording on the cassette deck.
- Between the audio output jacks on the cassette deck and the TAPE IN (PLAY) jacks — For playing a tape.

To connect audio equipment with an optical digital output terminal

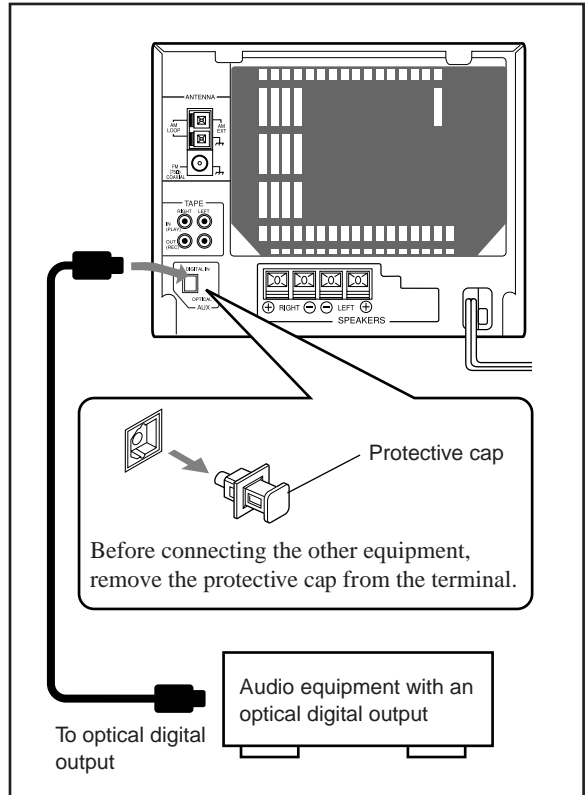

Connect between the optical digital output terminal on the other equipment and the AUX terminal.

NOW, you can plug in the unit and other connected equipment FINALLY!

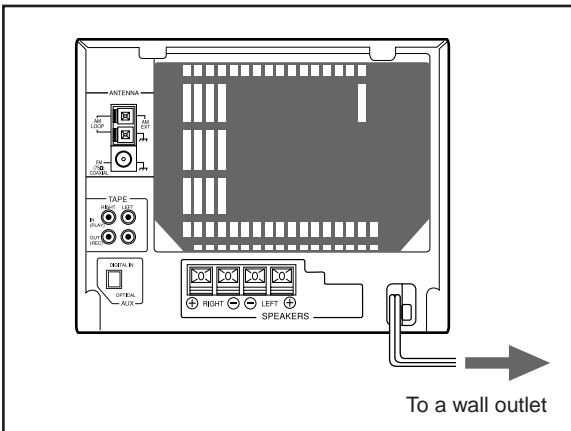

When connecting the AC power cord into a wall outlet, the unit automatically starts display demonstration.

- Pressing TITLE on the unit while the unit is turned on, shows the title entry screen (if there is no MD in the MD loading slot). You can experience how to select a character on this screen.

To stop and cancel the display demonstration, press ENTER/DEMO during display demonstration. “MODE OFF!” appears in the main display, the unit is turned off, then the display dims and “POWER SAVING” appears in the dimmed main display. After canceling the display demonstration, it will start only when the AC power cord is reconnected or when a power failure is recovered.

- Pressing any button on the unit or the remote control stops the demonstration temporarily.

To start the display demonstration manually
See “Changing the Main Display Screen” on page 12.



If you do not cancel the display demonstration, it will start automatically in the following cases

- 2 minutes after the unit is turned off.
- When no operation is done for more than 2 minutes after the unit is turned on.



If you do not want to start the display demonstration when the AC power cord is reconnected or when a power failure is recovered

See “To store the selected main display screen in backup memory” on page 13.

Putting the Batteries into the Remote Control

Insert the batteries — R6P(SUM-3)/AA(15F) — into the remote control, by matching the polarity (+ and –) on the batteries with the + and – markings on the battery compartment.

When the remote control can no longer operate the unit, replace both batteries at the same time.

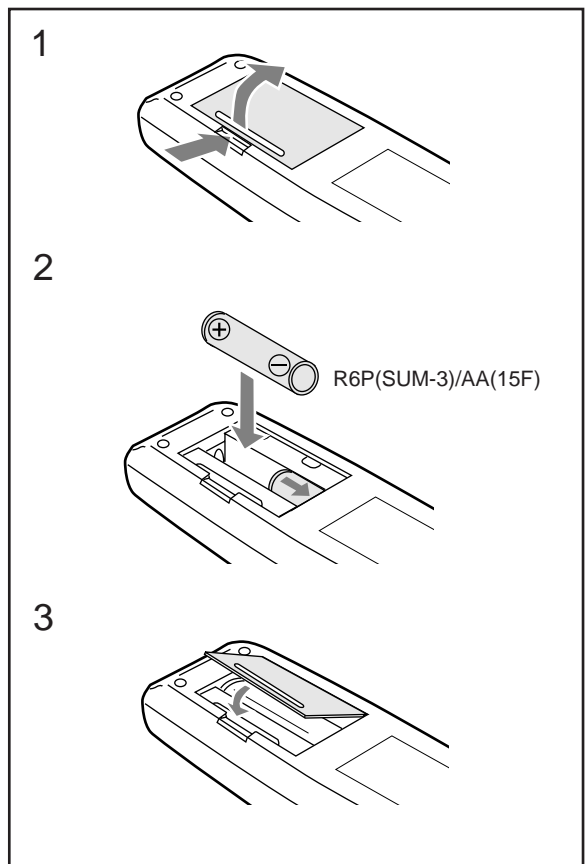

- DO NOT use an old battery together with a new one.
- DO NOT use different types of batteries together.
- DO NOT expose batteries to heat or flame.
- DO NOT leave the batteries in the battery compartment when you are not going to use the remote control for an extended period of time. Otherwise, it will be damaged from battery leakage.

The buttons and controls enlarged in the illustration below are used and explained in this section (pages 11 to 13).

Front panel

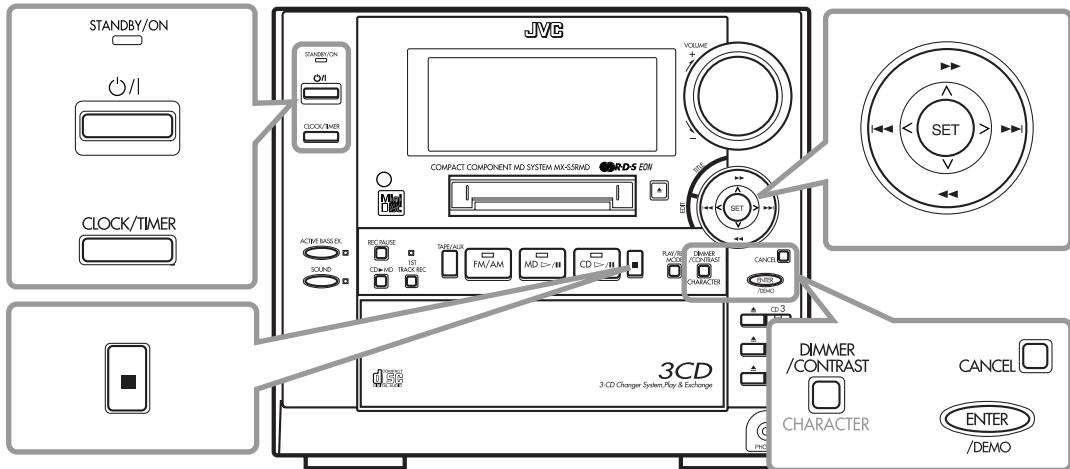

Remote control

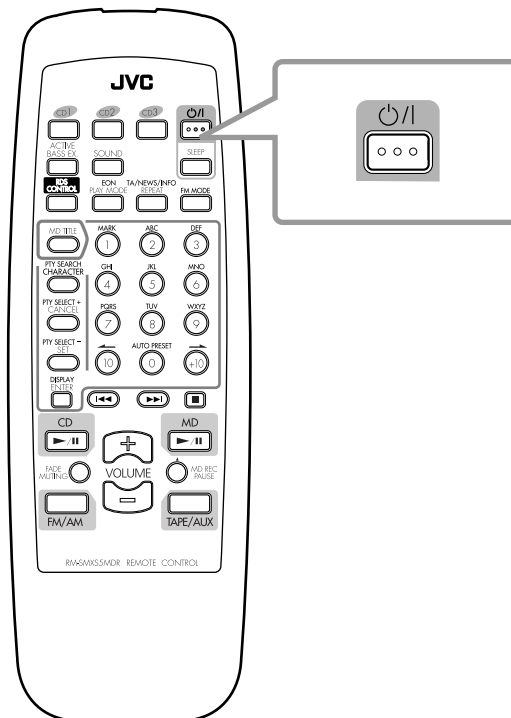

Before operating the unit any further, first set the clock built in this unit, then some other basic settings.

Turning On the Power

When you press the play button (▶/⏪) for a particular source or the source selecting buttons such as FM/AM and TAPE/AUX, the unit automatically turns on (and starts playback if the source is ready).

- Pressing SET on the unit also turns on the unit.

To turn on the unit without playing, press ⏻/I so that the STANDBY/ON lamp on the unit lights green.

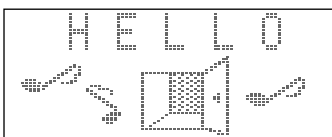

To turn off the unit (on standby), press ⏻/I again so that the STANDBY/ON lamp lights red.

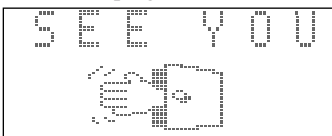

A little power is always consumed even while the unit is in standby mode.

To switch off the power supply completely, unplug the AC power cord from the AC outlet.



You can change the opening or ending screen illustrated above

Instead of showing the above opening or ending screen, you can make your original screens. To make and store your original screens, see "Creating Your Own Opening and Ending Screens" on page 49.



When you unplug the AC power cord or if a power failure occurs

The clock is reset to "0:00" right away, while the tuner preset stations and other settings will be erased in a few days.

Setting the Clock

You can set the clock whether the unit is turned on or in standby mode.

On the unit ONLY:

1 Press CLOCK/TIMER.

The hour digit in the main display starts flashing.

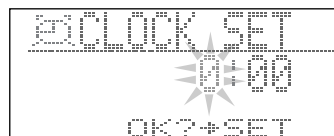

2 Push and hold the joy control rightward (▶▶|>) or leftward (◀◀|<) to adjust the hour, then press SET.



- If you want to correct the hour after pressing SET, press CANCEL. The hour digit starts flashing again.

3 Push and hold the joy control rightward (▶▶|>) or leftward (◀◀|<) to adjust the minute, then press SET.

"ADJUST OK!" appears in the main display, and the built-in clock starts.

To adjust the clock again

Once you have adjusted the clock, you need to press CLOCK/TIMER repeatedly until the CLOCK SET screen appears in the main display (the hour digit starts flashing).



If there is a power failure

The clock loses the setting and is reset to "0:00." You need to set the clock again.

Changing the Main Display Screen

You can change the screen pattern which appears in the main display.

On the unit ONLY:

You can do the following procedure while the unit is turned on or in standby mode.

1 Press ENTER/DEMO.

The DISPLAY MODE screen appears.

- If “MODE OFF” appears, press ENTER/DEMO again.

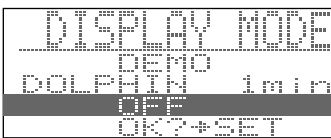

2 Push the joy control upward (▶▶ ^) or downward (◀◀ v) to select the screen pattern you want.

DEMO: To show the display demonstration in the main display.

When the AC power is unplugged, this setting is automatically restored unless you have stored another setting in backup memory. See “To store the selected main display screen in backup memory” on page 13.

DOLPHIN: To make dolphins swim in the main display. You can also select the starting-time (no operation period) when to start the dolphin screen.

OFF: To cancel the display demonstration and the dolphin screen.

3 When selecting “DOLPHIN” in the above step:

Push the joy control repeatedly rightward (▶▶▶ >) or leftward (◀◀◀ <) to select the starting-time (no operation period).

- You can select the starting-time from among 1, 3, and 5 minutes.

4 Press SET to finish the setting.

How these settings work

• When selecting “DEMO”:

Display demonstration starts.



If you do not cancel the display demonstration by pressing ENTER/DEMO, display demonstration automatically starts in the following cases:

- 2 minutes after the unit is turned off.
- When no operation is done for more than 2 minutes.

• When selecting “DOLPHIN”:

– If the unit is turned on: Dolphins start swimming in the lower portion of the main display.



If you press any button while dolphins are swimming in the main display, normal screen (see illustration below) resumes. However, dolphin starts swimming again if no operation is done for your specified starting-time (1, 3 and 5 minutes).

- If the unit is turned off (on standby): “DOLPHIN ON!” appears in the main display, and the unit is turned off again.

• When selecting “OFF”:

Both display demonstration and dolphin screen are canceled, and one of the following screens (normal screens) appears in the lower portion of the main display.



While recording or editing an MD

Display demonstration and dolphin screen will not appear.

Normal screens

Playback screen: while playing any source or receiving a station



Stop screen: while pausing or receiving no station:



- If the source is “TAPE” or “AUX DIGIT.,” only the playback screen will appear.

To store the selected main display screen in backup memory

You can store the selected main display screen in back up memory. So, even though the AC power is unplugged or a power failure occurs, the setting is kept in memory and will not be reset to the display demonstration.

On the unit ONLY:

- 1 Unplug the AC power cord.
- 2 Plug the AC power cord again while holding **■** and **ENTER/DEMO** at the same time.

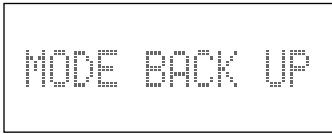

- 3 Select the main display screen setting (**DEMO**, **DOLPHIN**, or **OFF**) by following steps 1 to 4 on page 12.

To erase backup memory

Repeat steps 1 and 2 of the above procedure.

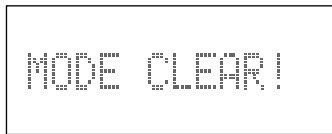

Backup memory is cleared.

- When the AC power plug is reconnected or a power failure is recovered, display demonstration automatically starts.

Changing the Display Brightness and Contrast

To change the brightness

You can change the display brightness whether the unit is turned on or in standby mode.

You can set and memorize the display brightness setting each for power-on time and for power-off (standby) time.

On the unit ONLY:

Press **DIMMER/CONTRAST**.

Each time you press the button, the display brightness changes as follows:

- When the unit is turned off (on standby):
Dark (POWER SAVING mode*) ←→ Dimmer**
- When the unit is turned on:
Bright ←→ Dimmer***

* During POWER SAVING mode:

- Much less electric power (1.6 watt) is consumed. If not selected, 14 watts of electric power are consumed even while the unit is turned off (on standby).
- “POWER SAVING” appears in the main display.
- You cannot insert an MD in the MD loading slot. To insert an MD, turn on the unit first.

** You can turn on the unit by inserting an MD in the MD loading slot.

*** When using some functions, the display window brightens for a while. For examples, when selecting the source either using the buttons on the unit or on the remote control, selecting the CD or MD track using the buttons on the remote control, etc.



During display demonstration

The display always brightens regardless of the dimmer setting.

To change the contrast

You can change the display contrast only when the unit is turned on.

On the unit ONLY:

- 1 Press and hold **DIMMER/CONTRAST** for more than 2 seconds.
The **CONTRAST ADJ.** screen appears.

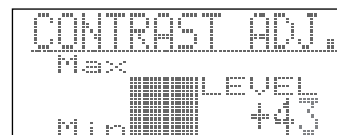

- 2 Push and hold the joy control upward (▶▶ ^) or downward (◀◀ v) to adjust the contrast.
 - You adjust the contrast within the range of 0 to +64.

- 3 Press **SET** to finish the adjustment.

Basic and Common Operations

Continued 

The buttons and controls enlarged in the illustration below are used and explained in this section (pages 15 to 16).

Front panel

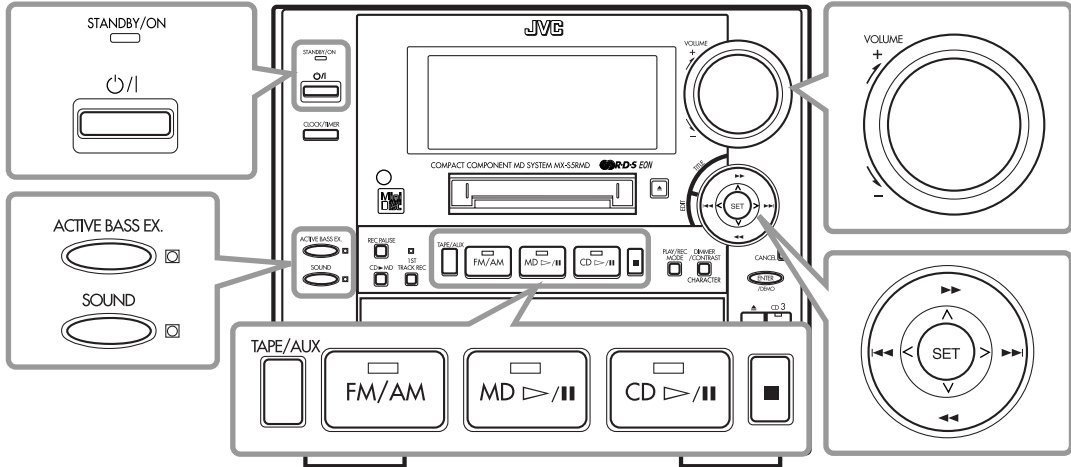

Remote control

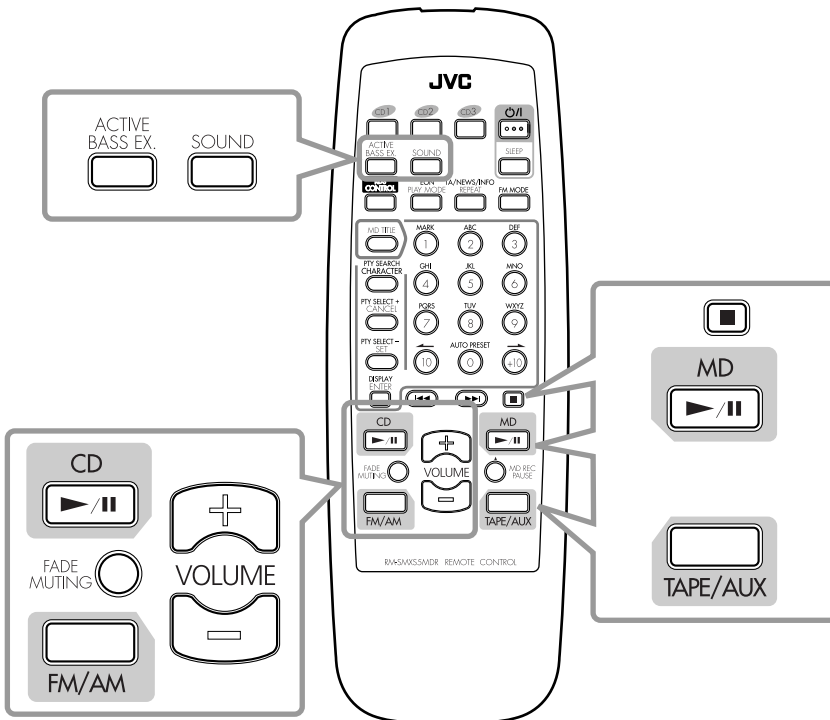

Selecting the Sources and Starting Play

To select the tuner as the source, press FM/AM. The unit automatically turns on, the lamp on the FM/AM button lights, and the last received station is tuned in.

- For more detailed operations, see pages 17 to 23.

To select the CD player as the source, press CD ▷/||. The unit automatically turns on, and the lamp on the CD ▷/|| button lights. (Play starts if a CD is on one of the CD trays.)

To stop play, press ■.

- For more detailed operations, see pages 24 to 27.

To select the MD player as the source, press MD ▷/||.

The unit automatically turns on and the lamp on the MD ▷/|| button lights. (Play starts if an MD is in the MD loading slot).

To stop play, press ■.

- For more detailed operations, see pages 28 to 31.

To select the external equipment as the source, press TAPE/AUX. The unit automatically turns on.

- Each time you press the button, the source alternate between “TAPE” and “AUX DIGIT.”

TAPE: To use the equipment connected to the TAPE jacks.

When selecting “TAPE,” the sound input level appears for a while. (See page 34 for the sound input level.)

AUX DIGIT. (DIGITAL): To use the digital equipment connected to the AUX terminal.

- For operating the external equipment, see the manuals supplied with them.



While selecting the digital equipment (“AUX DIGITAL”) as the source

The sampling frequency of the connected digital equipment is shown in the main display. (If no equipment is connected to the AUX terminal, “UNLOCK” appears.)



Ex. When the sampling frequency is 44.1 kHz

Adjusting the Volume

You can adjust the volume level only while the unit is turned on.

Turn VOLUME clockwise to increase the volume or counterclockwise to decrease it.

When using the remote control, press VOLUME + to increase the volume or press VOLUME – to decrease it.



For private listening

Connect a pair of headphones to the PHONES jack. No sound comes out of the speakers. Be sure to turn down the volume before connecting or putting on the headphones.



DO NOT turn off (on standby) the unit with the volume set to an extremely high level; otherwise, the sudden blast of sound can damage your hearing, speakers and/or headphones when you turn on the unit or start playing any source.

REMEMBER you cannot adjust the volume level while the unit is in standby mode.

To turn down the volume level temporarily

Press FADE MUTING on the remote control.

To restore the sound, press the button again.

Reinforcing the Bass Sound

The richness and fullness of the bass sound is maintained regardless of how low you set the volume.

You can use this effect only for playback.

To get the effect, press ACTIVE BASS EX. (extension) so that the ACTIVE BASS EX. on the unit lamp lights up.



To cancel the effect, press the button again so that the lamp goes off.



Selecting the Sound Modes

You can select one of the 6 preset sound modes (3 surround modes and 3 SEA – Sound Effect Amplifier – modes) and 1 manual mode. The sound modes can be applied only to playback sounds, and cannot be used for recording.

To select the sound modes, press SOUND until the sound mode you want appears on the display. The SOUND lamp also lights.

- Each time you press the button, the sound modes change as follows:

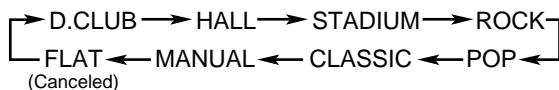

Surround modes*:

D. (Dance) CLUB: Increases resonance and bass.

HALL: Adds depth and brilliance to the sound.

STADIUM: Adds clarity and spreads the sound, like in an outdoor stadium.

SEA modes:

ROCK: Boosts low and high frequency. Good for acoustic music.

POP: Good for vocal music.

CLASSIC: Good for classical music.

Manual mode:

MANUAL: Your individual mode stored in memory. See “Creating Your Own Sound Mode — MANUAL Mode.”

FLAT: Cancels the sound mode.

* Surround elements are added to the sound modes to create a being-there feeling in your room.

To check the sound mode currently selected, press SOUND once while the SOUND lamp on the unit is lit. The currently selected sound mode screen will appear in the main display.

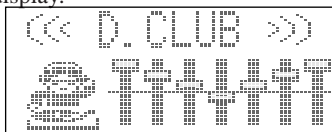

Ex. when “D.CLUB” is currently selected.

Creating Your Own Sound Mode — MANUAL Mode

You can create and store your own sound mode.

- There is a time limit in doing the following steps. If the setting is canceled before you finish, start from step 1 again.

On the unit ONLY:

- Press SOUND repeatedly until “MANUAL” appears in the main display.

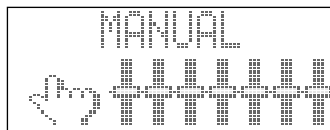

- Press SET.

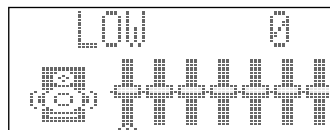

- Adjust the equalizer pattern.

- Push the joy control rightward (▶▶ >) or leftward (◀◀ <) to select the frequency range to adjust (LOW, MID, HIGH).
- Push the joy control upward (▶▶ ^) or downward (◀◀ v) to adjust the level (-3 to +3) of the selected frequency range.

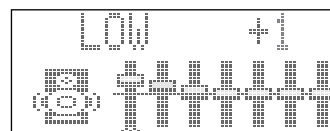

- Repeat steps 1) and 2) to adjust the level of the other frequency ranges.

- Press SET again (or wait until the above indication disappears).

The equalizer pattern you have created is stored in memory.

To use your own sound mode

Select “MANUAL” when using the sound modes. See “Selecting the Sound Modes.”

Listening to FM and AM (MW/LW) Broadcasts

The buttons and controls enlarged in the illustration below are used and explained in this section (pages 18 to 23).

Front panel

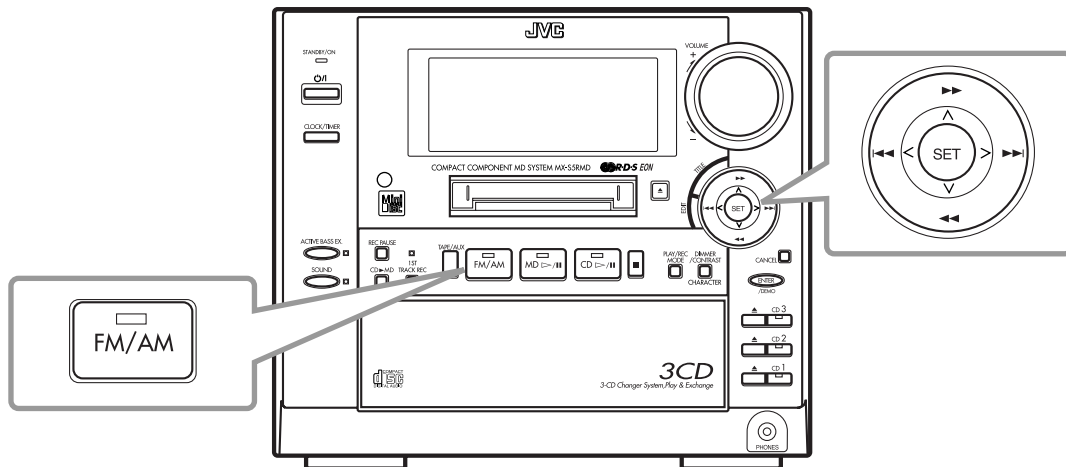

Remote control

You cannot use the buttons on the front panel to operate the RDS functions. Use only buttons on the remote control.

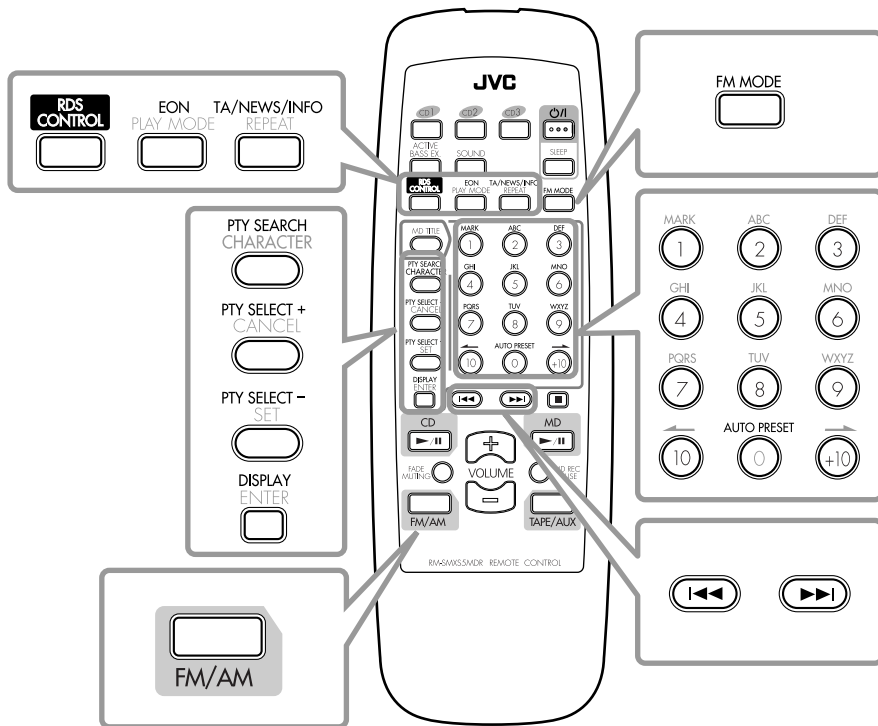

Tuning in a Station

On the unit:

1 Press FM/AM.

The unit automatically turns on and tunes in the previously tuned station (either FM or AM–MW/LW).

- Each time you press the button, the band alternates between FM and AM.

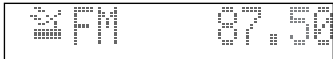

2 Tune into a station.

On the unit:

Push and hold the joy control upward (▶▶ ^) or downward (◀◀ ∨) until the station frequencies start changing in the main display.

- Upward (▶▶ ^): to increase the frequencies.
- Downward (◀◀ ∨): to decrease the frequencies.

On the remote control:

Press and hold ▶▶| or |◀◀ until the station frequencies start changing in the main display.

- ▶▶|: to increase the frequencies.
- |◀◀: to decrease the frequencies.

The unit starts searching stations and stops when a station of sufficient signal strength is tuned in (the TUNED indicator lights).

- If an FM program is broadcast in stereo, the STEREO indicator also lights.

To stop during searching, press SET (or |◀◀/▶▶| on the remote control).



When you repeatedly push the joy control upward or downward (or |◀◀/▶▶| on the remote control)

The frequency changes step by step.

To change the FM reception mode

When an FM stereo broadcast is hard to receive or noisy, press FM MODE on the remote control so that “MONO” appears in the main display. Reception improves.

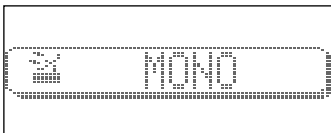

To restore the stereo effect, press FM MODE again so that “AUTO” appears in the main display.

In this stereo mode, you can hear stereo sounds when a program is broadcast in stereo.

Presetting Stations

You can preset 30 FM and 15 AM (MW/LW) stations — using either automatic presetting method or manual presetting method.

In some cases, test frequencies have been already memorized for the tuner since the factory examined the tuner preset function before shipment. This is not a malfunction. You can preset the stations you want into memory by following the presetting method.

- There is a time limit in doing the following steps. If the setting is canceled before you finish, start from step 1 again.

To preset stations automatically — Automatic Presetting

On the remote control ONLY:

You need to preset stations separately for the FM and AM bands.

1 Press FM/AM to select the band.

2 Press and hold AUTO PRESET until “A. PRESET” appears in the main display for about 2 seconds.

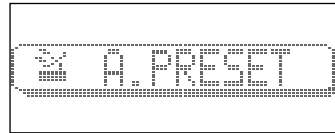

Local stations with strong signals are searched and stored in memory automatically.

When automatic preset is over, the station stored in preset number 1 is received.

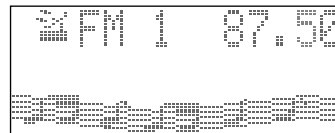

3 Repeat steps 1 and 2 to store stations of the other band.



When you cannot store stations you want automatically

Stations with weak signals cannot be detected with this automatic presetting method. To store such a station, use the manual presetting method on page 19.

To preset stations manually — Manual Presetting

- 1 **Tune in the station you want to preset.**
 - See “Tuning in a Station” on page 18.



- 2 **Press SET.**

The current preset number starts flashing.

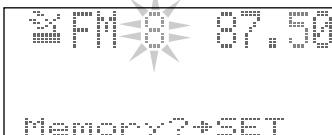

- 3 **Select a preset number.**

On the unit:
Push the joy control rightward (▶▶| >) or leftward (|◀◀ <).

 - Rightward (▶▶| >): to increase the preset numbers.
 - Leftward (|◀◀ <): to decrease the preset numbers.

On the remote control:

Press the number buttons.

- Ex. For preset number 5, press 5.
For preset number 15, press +10, then 5.
For preset number 20, press +10, then 10.

- 4 **Press SET again.**

The tuned station in step 1 is stored in the preset number selected in step 3.



- Storing a new station on a used number erases the previously stored one.



When you unplug the AC power cord or if a power failure occurs

The preset stations will be erased in a few days. If this happens, preset the stations again.

Tuning in a Preset Station

- 1 **Press FM/AM.**

The unit automatically turns on and tunes in the previously tuned station (either FM or AM–MW/LW).

 - Each time you press the button, the band alternates between FM and AM (MW/LW).

- 2 **Select a preset number.**

On the unit:
Push the joy control rightward (▶▶| >) or leftward (|◀◀ <).

 - Rightward (▶▶| >): to increase the preset numbers.
 - Leftward (|◀◀ <): to decrease the preset numbers.

On the remote control:

Press the number buttons.

- Ex. For preset number 5, press 5.
For preset number 15, press +10, then 5.
For preset number 20, press +10, then 10.

Receiving FM Stations with RDS

RDS allows FM stations to send an additional signal along with their regular program signals. For example, the stations send their station names, as well as information about what type of program they broadcast, such as sports or music, etc.

When tuned to an FM station which provides the RDS service, the RDS indicator lights on the display.

With the unit, you can receive the following types of RDS signals.

PS (Program Service):

Shows commonly known station names.

PTY (Program Type):

Shows types of broadcast programs.

RT (Radio Text):

Shows text messages the station sends.

EON (Enhanced Other Networks):

Provides the information about the types of the programs sent by other RDS stations than the one being received.

RDS operations are possible only using the remote control. You can use the buttons printed in orange on the remote control.

**More about RDS**

- Not all FM stations provide RDS signals, nor do all RDS stations provide the same services. If in doubt, check with local radio stations for details on RDS in your area.
- RDS may not work correctly if the received station is not transmitting the signals properly or if the signal strength is weak.

Changing the RDS Information

You can see RDS information on the display while listening to an FM station.

1 Press RDS CONTROL while listening to an FM station.

2 Press DISPLAY.

- Each time you press the button, the display changes to show the following information:

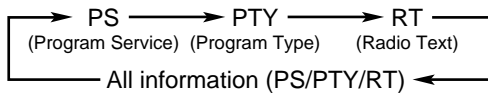

If No PS, PTY, or RT signals are sent by a station
“NO PS,” “NO PTY” or “NO RT” appears in the main display.



If the unit takes time to show the RDS information received from a station

“WAIT PS”, “WAIT PTY”, or “WAIT RT” may appear on the display.

Searching for Programs by PTY Codes (PTY Search)

One of the advantages of RDS is that you can locate a particular kind of program by specifying the PTY codes.

- The PTY Search is applicable only to the preset stations.
- There is a time limit in doing the following steps. If the setting is canceled before you finish, start from step 1 again.

To search for a program using the PTY codes, use the remote control:

1 Press RDS CONTROL while listening to an FM station.

2 Press PTY SEARCH.

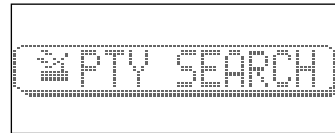

3 Press PTY SELECT +/- to select a PTY code while “PTY SELECT” is flashing.

- Each time you press the button, the PTY codes change as follows (refer also to the list on page 23):

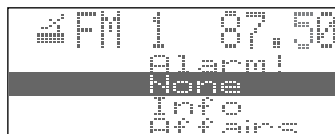

None ⇄ News ⇄ Affairs ⇄ Info ⇄
 Sport ⇄ Educate ⇄ Drama ⇄ Culture ⇄
 Science ⇄ Varied ⇄ Pop M ⇄ Rock M ⇄
 Easy M ⇄ Light M ⇄ Classics ⇄
 Other M ⇄ Weather ⇄ Finance ⇄ Children ⇄
 Social ⇄ Religion ⇄ Phone In ⇄ Travel ⇄
 Leisure ⇄ Jazz ⇄ Country ⇄ Nation M ⇄
 Oldies ⇄ Folk M ⇄ Document ⇄ TEST ⇄
 Alarm! ⇄ (back to the beginning)

4 Press PTY SEARCH again.

While searching, the selected PTY code appears and “SEARCH” flashes in the main display.

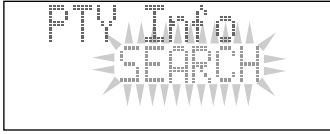

The unit searches 30 preset FM stations, stops when it finds the one you have selected, and tunes in that station.

To continue searching after the first stop:

Press PTY SEARCH again while the indications on the display are flashing.

If no program is found, “NOT FOUND” appears on the display and the unit returns to the last received station.

To stop searching any time during the process:

Press PTY SEARCH while searching.

Switching to a Program Type of Your Choice Temporarily

The EON function allows the unit to switch temporarily to a broadcast program of your choice (TA, NEWS, and/or INFO) from a different station except when you are listening to a non-RDS stations — some FM stations and AM (MW/LW) stations.

- The EON indicator lights while receiving a station with the EON code.
- EON function is applicable only to preset stations.

To activate the EON function, use the remote control:

1 Press RDS CONTROL while listening to an FM station.

2 Press EON.

“EON ON” appears in the main display, and the last EON data type selected — TA/NEWS/INFO — lights on the display window.

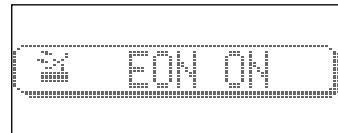

3 Press TA/NEWS/INFO repeatedly until the EON data type you want is selected.

- Each time you press the button, the EON data types change as follows:

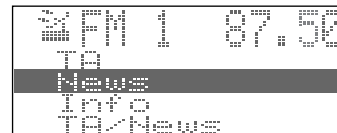

TA → News → Info → TA/News →
News /Info → TA/Info → TA/News/Info →
(back to the beginning)

TA: Traffic announcement

News: News

Info: Programs the purpose of which is to impart advice in the widest sense.

To cancel the EON function, press EON again so that the TA/NEWS/INFO indicator goes off. “EON OFF” also appears in the main display for a while.

- If you cancel the EON function while receiving a program selected by the EON function, the unit goes back to the previously tuned station.

How the EON function actually works:**CASE 1****If there is no station broadcasting the program you have selected**

The unit continues tuning in the current station.



When a station starts broadcasting the program you have selected, the unit automatically switches to the station. The indicator of received PTY code starts flashing.



When the program is over, “EON END” appears in the main display, and the unit goes back to the previously tuned station, but the EON function still remains activated.

CASE 2**If there is a station broadcasting the program you have selected**

The unit tunes in the program. The indicator of received PTY code starts flashing.



When the program is over, “EON END” appears in the main display, and the unit goes back to the previously tuned station, but the EON function still remains activated.

CASE 3**If the FM station you are listening to is broadcasting the program you have selected**

The unit continues to receive the station but the indicator of received PTY code starts flashing.



When the program is over, the indicator of received PTY code stops flashing and remains lit, but the EON function still remains activated.

Alarm function

If an “Alarm!” (Emergency) signal is received from a station while listening to the radio, the unit automatically switches to the station broadcasting the “Alarm!” signal, except when you are listening to non-RDS stations (all AM – MW/LW and some FM stations).

Test function

The TEST signal is used for testing the “Alarm!” signal. Therefore, it makes the unit work in the same way as the “Alarm!” signal does.

If a TEST signal is received from a station while listening to the radio, the unit automatically switches to the station broadcasting the TEST signal, except when you are listening to non-RDS stations (all AM – MW/LW and some FM stations).

**More about the EON function**

- EON data sent from some stations may not be compatible with this unit.
- While listening to a program tuned in by the EON function, the station does not change even if another network station starts broadcasting a program of the same EON data.
- While listening to a program tuned in by the EON function, you can only use the EON and DISPLAY buttons as the tuner operation buttons. If you press any other tuner operation button, “EON LOCKED!” appears in the main display.
- If the stations alternate intermittently between the station tuned by the EON function and the currently tuned station (“WAITING” flashes in the main display), press EON to cancel the EON function.

If you do not press the button, the currently tuned station is received finally (“NOT FOUND” appears this time), and the indication of the EON data type flashing on the display disappears.

Description of the PTY codes:

None:	Undefined.	Finance:	Stock Market reports, commerce, trading etc.
News:	News.	Children:	Programs targeted at a young audience.
Affairs:	Topical program expanding or enlarging upon the news — debate, or analysis.	Social:	Programs about sociology, history, geography, psychology and society.
Info:	Programs the purpose of which is to impart advice in the widest sense.	Religion:	Religious programs.
Sport:	Programs concerned with any aspect of sports.	Phone In:	Involving members of the public expressing their views either by phone or at a public forum.
Educate:	Educational programs.	Travel:	Travel information.
Drama:	All radio plays and serials.	Leisure:	Programs about recreational activities.
Culture:	Programs concerning any aspect of national or regional culture, including language, theater, etc.	Jazz:	Jazz music.
Science:	Programs about natural sciences and technology.	Country:	Songs which originate from, or continue the musical tradition of the American Southern States.
Varied:	Used for mainly speech-based programs such as quizzes, panel games and personality interviews.	Nation M:	Current popular music of the nation or region in that country's language.
Pop M:	Commercial music of current popular appeal.	Oldies:	Music from the so-called "golden age" of popular music.
Rock M:	Rock music.	Folk M:	Music which has its roots in the musical culture of a particular nation.
Easy M:	Current contemporary music considered to be "easy-listening."	Document:	Programs concerning factual matters, presented in an investigative style.
Light M:	Instrumental music, and vocal or choral works.	TEST:	Broadcasts for testing emergency broadcast equipment or receiver.
Classics:	Performances of major orchestral works, symphonies, chamber music, etc.	Alarm!:	Emergency announcement.
Other M:	Music not fitting into any of the other categories.	Classification of the PTY codes for some FM stations may be different from the above list.	
Weather:	Weather reports and forecasts.		

Playing Back CDs

Continued 

The buttons and controls enlarged in the illustration below are used and explained in this section (pages 25 to 27).

Front panel

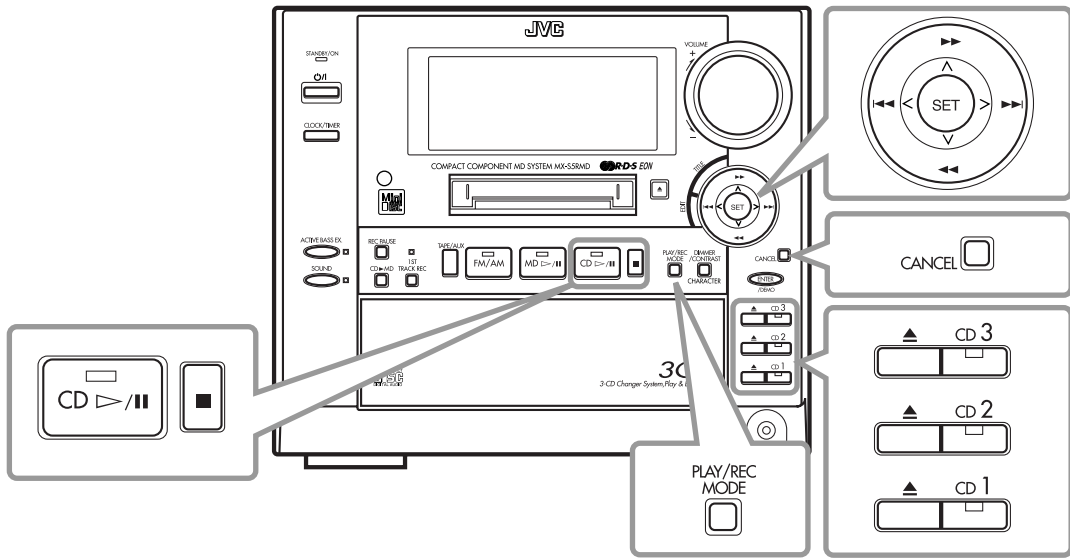

Remote control

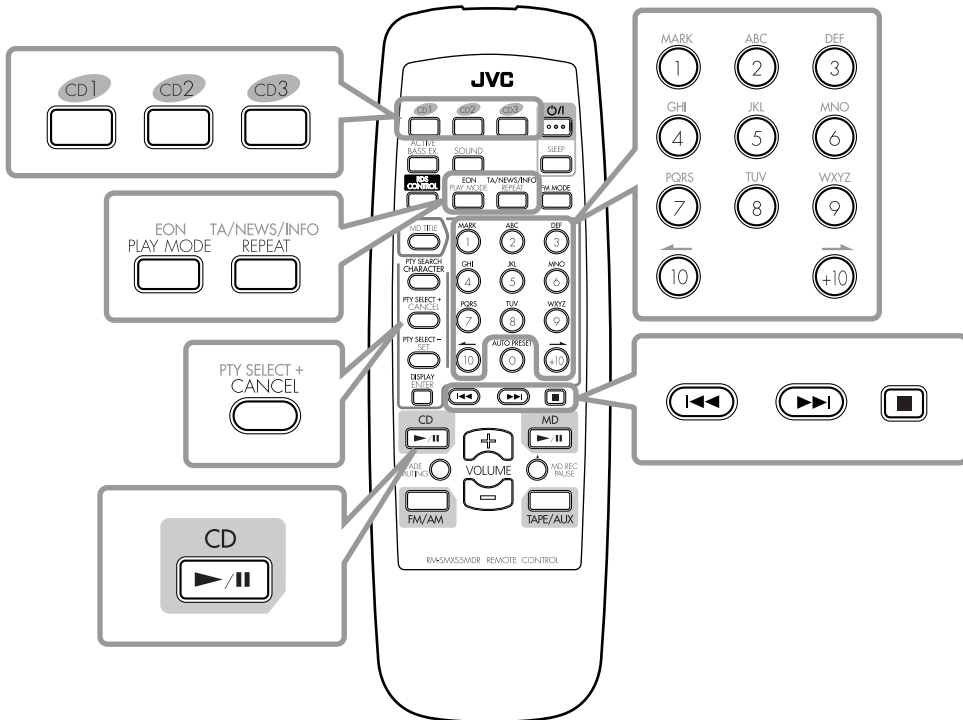

Loading CDs

1 Press one of the open/close buttons (▲) for the disc tray (CD 1 to CD 3) you want to load a CD onto. The unit automatically turns on and the selected disc tray comes out. The corresponding CD number lamp (CD 1 to CD 3) lights.

2 Place a disc correctly on the circle of the disc tray, with its label side up.

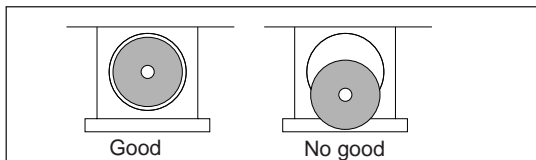
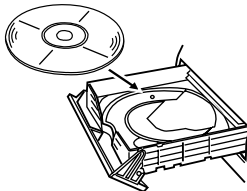

- When using a CD single (8 cm), place it on the inner circle of the disc tray.

3 Press the same open/close button (▲) you have pressed in step 1. The disc tray closes.

4 Repeat steps 1 to 3 to place other CDs.



When loading more than one CD continuously

Press the open/close button (▲) for the next tray you want to place a CD onto. The first disc tray automatically closes and the next disc tray comes out.



About the disc number lamps (CD 1 to CD 3 buttons)

Each disc number lamp corresponds to the disc tray of the same number.

- It lights orange when you press ▲ and when the unit has recognized that there is a CD on the corresponding disc tray.
- It lights green when a disc on the corresponding disc tray is currently selected.
- It flashes orange and green alternately, then goes off when the unit has recognized that there is no CD on the corresponding disc tray.

Playing Back the Entire Discs — Continuous Play

You can play CDs continuously.

1 Load CDs.

2 Press one of the disc number buttons (CD 1, CD 2 and CD 3) for the disc you want to play. CD playback starts from the first track of the selected disc.

This shows the currently selected disc.

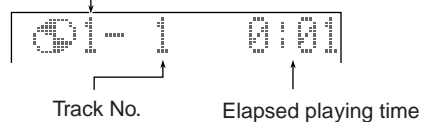

- Pressing CD ▷ / || instead of the CD number buttons starts playing back the currently selected CD.

To stop during play, press ■.

To remove the disc, press the corresponding open/close buttons (▲).



CD playback sequence

When 3 CDs are loaded on the disc trays, they are played in one of the following sequences.

- When CD 1 is pressed : CD 1 ⇒ CD 2 ⇒ CD 3 (then stops)
- When CD 2 is pressed : CD 2 ⇒ CD 3 ⇒ CD 1 (then stops)
- When CD 3 is pressed : CD 3 ⇒ CD 1 ⇒ CD 2 (then stops)
- * If no CD is on the disc trays, CD player skips such an empty tray.

Basic CD Operations

While playing a CD, you can do the following operations.

To exchange CDs during playback of another Press the open/close button (▲) corresponding to a disc number not currently being played to eject that disc tray and exchange the CD.

If CDs are exchanged during playback, playback will stop after playing all newly inserted CDs.

To stop playback for a moment

Press CD ▷ / ■.

To resume play, press CD ▷ / ■ again.

To locate a particular point in a track during play

On the unit:

Push the joy control upward (▶▶ ^) or downward (◀◀ v).

- Upward (▶▶ ^): Fast-forwards the tracks.
- Downward (◀◀ v): Fast-reverses the tracks.

On the remote control:

Press and hold ▶▶| or |◀◀.

- ▶▶|: Fast-forwards the tracks.
- |◀◀: Fast-reverses the tracks.

To go to another track

On the unit:

Push repeatedly (or hold) the joy control rightward (▶▶| >) or leftward (|◀◀ <).

- Rightward (▶▶| >): Skips to the beginning of the next or succeeding tracks.
- Leftward (|◀◀ <): Goes back to the beginning of the current or previous tracks.

On the remote control:

Press ▶▶| or |◀◀ repeatedly.

- ▶▶|: Skips to the beginning of the next or succeeding tracks.
- |◀◀: Goes back to the beginning of the current or previous tracks.

To go to another track directly using the number buttons

Pressing the number button(s) allows you to start playing the track number you want.

Ex.: For track number 5, press 5.

For track number 15, press +10, then 5.

For track number 20, press +10, then 10.

For track number 32, press +10, +10, +10, then 2.

Programming the Playing Order of the Tracks — Program Play

You can arrange the order in which the tracks play before you start playing. You can program up to 32 tracks.

1 Load CDs.

- If the current playing source is not the CD player, press CD ▷ / ■, then ■ before going to the next step.

2 Press PLAY/REC MODE (or PLAY MODE on the remote control) so that “CD PROGRAM” appears in the main display.

The PRGM indicator also lights.

- Each time you press the button, play mode changes as follows:

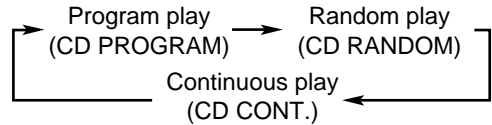

3 Press one of the disc number buttons (CD 1, CD 2, and CD 3) to select the disc number you want to play.

- When using the buttons on the unit, you can use the joy control to select the CD number by pushing it upward (▶▶ ^) or downward (◀◀ v).

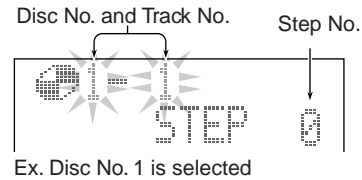

4 Select the track from the disc selected in the above step.

On the unit:

Push the joy control rightward (▶▶| >) or leftward (|◀◀ <) to select the track number, then press SET.

On the remote control:

Press the number buttons.

- For how to use the number buttons, see “To go to another track directly using the number buttons” to the left.

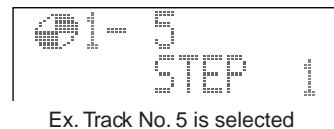

5 Program other tracks you want.

- To program tracks from the same disc, repeat step 4.
- To program tracks from a different disc, repeat steps 3 and 4.

6 Press CD ▷ / ■.

- The tracks are played in the order you have programmed.

To stop during play, press ■.

To exit from Program play mode, press PLAY/REC MODE (or PLAY MODE on the remote control) once or twice, before or after play, so that the unit enters another playback mode (Random play or Continuous play mode).

To check the program contents

Before playing, you can check the program contents by pressing ►►| or |◄◄ on the remote control.

- ►►| : Shows the programmed tracks in the programmed order.
- |◄◄ : Shows them in the reverse order.

To modify the program

Before playing, you can erase the last programmed track by pressing CANCEL. Each time you press the button, the last programmed track is erased from the program.

- When you eject a disc, the tracks selected from that ejected disc are erased from the program.

To add tracks in the program before you start play, simply select track numbers you want to add.

To erase the entire program, before or after play, press and hold CANCEL on the unit until “CD PROGRAM ALL CLEAR” appears in the main display.

- Turning off the unit also erases the entire program.



If you try to program a 33rd step

“CD PROGRAM FULL” will appear in the main display.



If your entry is ignored

You have tried to program a track from an empty tray, or a track number that does not exist on the CD (for example, selecting track 14 on a CD that only has 12 tracks). Such entries are ignored.

Playing at Random — Random Play

The tracks of all loaded CDs will play at random.

1 Load CDs.

- If the current playing source is not the CD player, press CD ▷ / II, then ■ before going to the next step.

2 Press PLAY/REC MODE (or PLAY MODE on the remote control) repeatedly until “CD RANDOM” appears in the main display.

The RANDOM indicator also lights.

- Each time you press the button, play mode changes as follows:

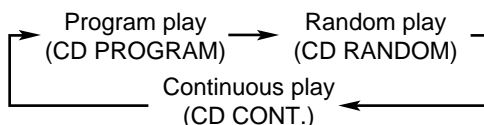

3 Press CD ▷ / II.

The tracks are played at random.

Random play stops when all the tracks are played once.

To skip the playing track, push the joy control rightward (►►| >) or press ►►| on the remote control.

- You cannot go back to the previous tracks by pushing the joy control leftward (|◄◄ <) or pressing |◄◄ on the remote control.

To stop during play, press ■.

- Random play also stops when you open a disc tray.

To exit from Random play mode, press PLAY/REC MODE (or PLAY MODE on the remote control) once or twice, before or after play, so that the unit enters another playback mode (Continuous play or Program play mode).

- Pressing one of the disc number buttons (CD 1, CD 2, and CD 3) starts Continuous play from the first track of the selected disc.
- Pressing one of the number buttons will start Continuous play from the selected track of the currently selected disc.

Repeating Tracks or CDs — Repeat Play

You can have all the CDs, the program or the individual track currently playing repeat as many times as you like.

On the remote control ONLY:

To repeat play, press REPEAT during or before playing.

Each time you press the button, Repeat play mode changes and appears in the main display as follows:

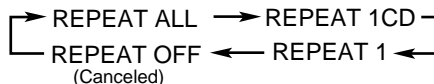

Ex. When “REPEAT ALL” is selected

REPEAT ALL: Repeats all the tracks on all the CDs (continuously or at random), or all the tracks in the program.

REPEAT 1CD*: Repeats all the tracks on one CD.

REPEAT 1: Repeats one track on one CD.

REPEAT OFF: Cancels the repeat play.

* REPEAT 1CD is not used for Program play and Random play.

To prohibit disc ejection — Disc Lock

You can prohibit CD and MD ejection from the unit, and can lock the discs.

See page 31 for details.

Playing Back an MD

Continued 

The buttons and controls enlarged in the illustration below are used and explained in this section (pages 29 to 31).

Front panel

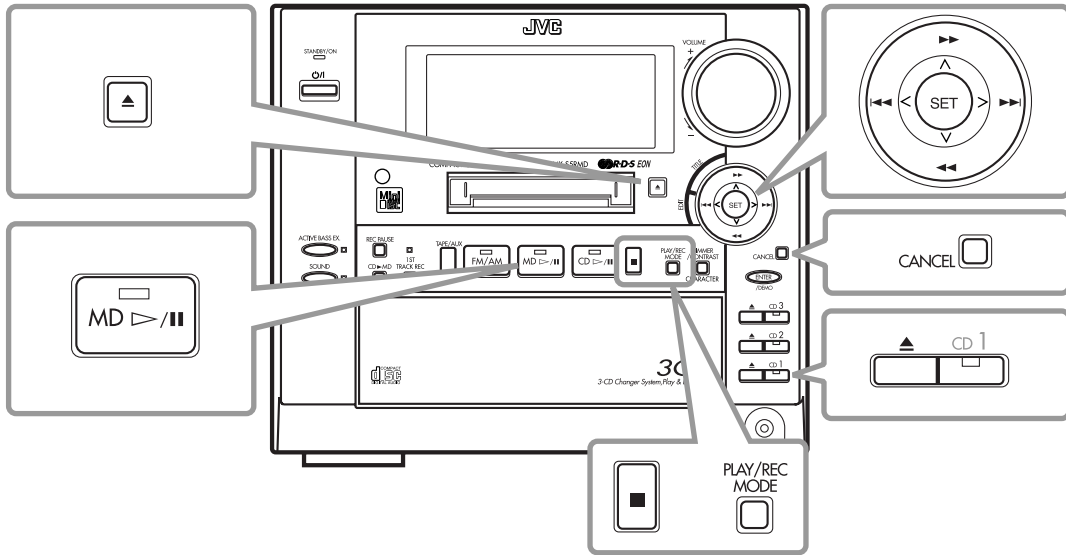

Remote control

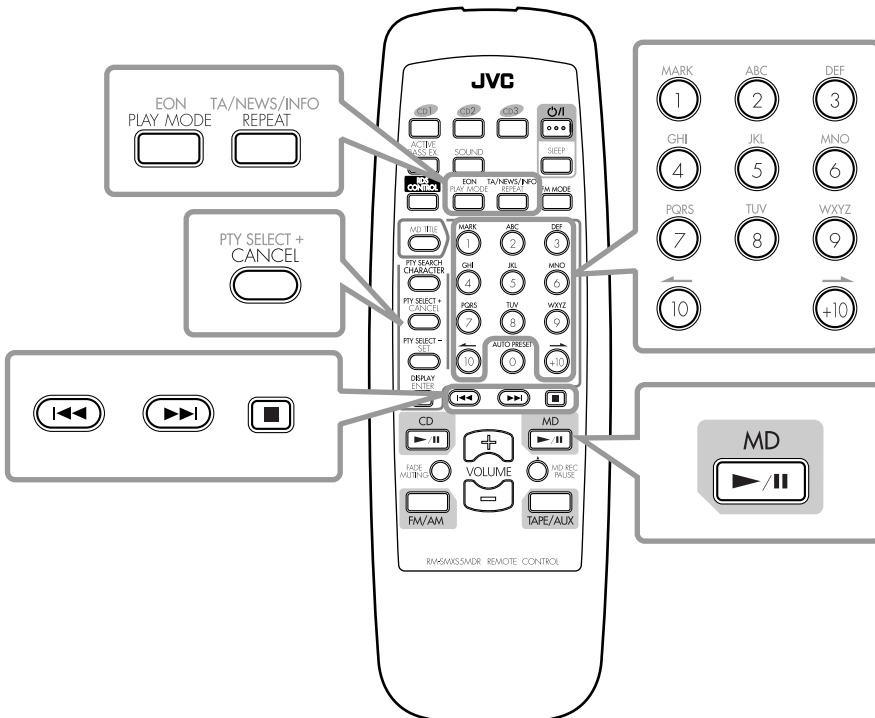

Playing Back the Entire MD — Normal Play

You can play an MD.

1 Insert an MD into the MD loading slot.

The MD is pulled in automatically.

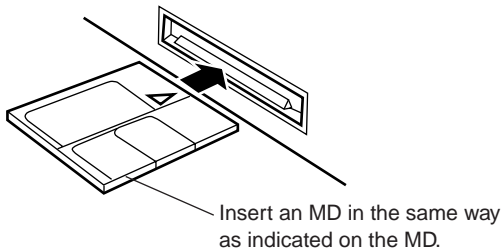

MD LOADING

MD READING

Total Track No. 17 Total Playing time 20:56

2 Press MD ▷ / II.

MD playback starts from the first track.

Track No. 01 Elapsed playing time 1:56

To stop during play, press ■.

To remove the disc, press ▲ for the MD recorder.



If the MD or track has a title

The title will be shown at the center portion of the main display. (If a title is long and cannot be shown at a time, the unit scrolls the title to show the entire title.)



If you cannot insert an MD

You have inserted an MD incorrectly and taken it off by force. In this case, MD loading slot rejects MD insertion. If this occurs, wait for about one minute with the unit turned on until a mechanical sound comes out of the MD mechanism.

Basic MD Operations

While playing an MD, you can do the following operations.

To stop playback for a moment

Press MD ▷ / II.

To resume play, press MD ▷ / II again.

To locate a particular point in a track during play

On the unit:

Push the joy control upward (▶▶ ^) or downward (◀◀ v).

- Upward (▶▶ ^): Fast-forwards the tracks.
- Downward (◀◀ v): Fast-reverses the tracks.

On the remote control:

Press and hold ▶▶▶ or ◀◀◀.

- ▶▶▶: Fast-forwards the tracks.
- ◀◀◀: Fast-reverses the tracks.

To go to another track

On the unit:

Push repeatedly (or hold) the joy control rightward (▶▶▶ >) or leftward (◀◀◀ <).

- Rightward (▶▶▶ >): Skips to the beginning of the next or succeeding tracks.
- Leftward (◀◀◀ <): Goes back to the beginning of the current or previous tracks.

On the remote control:

Press ▶▶▶ or ◀◀◀ repeatedly.

- ▶▶▶: Skips to the beginning of the next or succeeding tracks.
- ◀◀◀: Goes back to the beginning of the current or previous tracks.

To go to another track directly using the number buttons

Pressing the number button(s) allows you to start playing the track number you want.

Ex.: For track number 5, press 5.

For track number 15, press +10, then 5.

For track number 20, press +10, then 10.

For track number 32, press +10, +10, +10, then 2.

Programming the Playing Order of the Tracks — Program Play

You can arrange the order in which the tracks play before you start playing. You can program up to 32 tracks.

1 Load an MD.

- If the current playing source is not the MD recorder, press MD ▷ / II, then ■ before going to the next step.

2 Press PLAY/REC MODE (or PLAY MODE on the remote control) so that “MD PROGRAM” appears in the main display.

The PRGM indicator also lights.

- Each time you press the button, play mode changes as follows:

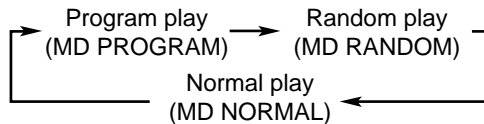

3 Select the track.

On the unit:

Push the joy control rightward (▶▶| >) or leftward (|◀◀ <) to select the track number, then press SET.

On the remote control:

Press the number buttons.

- For how to use the number buttons, see “To go to another track directly using the number buttons” on page 29.

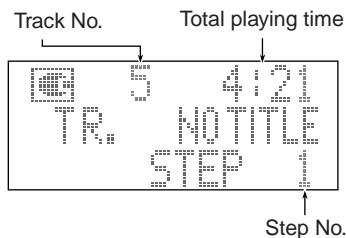

Ex. When selecting track 5

- If the selected track has a title, it will be shown at the center portion of the main display. (If the title is long and cannot be shown at a time, the unit scrolls the title to show the entire title.)

4 Repeat step 3 to program other tracks you want.

5 Press MD ▷ / II.

The tracks are played in the order you have programmed.

To stop during play, press ■.

To exit from Program play mode, press PLAY/REC MODE (or PLAY MODE on the remote control) once or twice so that the unit enters another playback mode (Random play or Normal play mode).

To check the program contents

Before playing, you can check the program contents by pressing ▶▶| or |◀◀ on the remote control.

- ▶▶| : Shows the programmed tracks in the programmed order.
- |◀◀ : Shows them in the reverse order.

To modify the program

Before playing, you can erase the last programmed track by pressing CANCEL. Each time you press the button, the last programmed track is erased from the program.

To add tracks in the program before you start play, simply select track numbers you want to add.

To erase the entire program, before or after play, press and hold CANCEL on the unit until “MD PROGRAM ALL CLEAR” appears in the main display.

- When you eject the disc or turn off the unit, the entire program is also erased.



If you try to program a 33rd step

“MD PROGRAM FULL” will appear in the main display.



If your entry is ignored

You have tried to program a track that does not exist on the MD (for example, selecting track 14 on an MD that only has 12 tracks). Such entries are ignored.



If the total playing time exceed 150 minutes

The playing time will not be shown. (“--- : ---” will appear.)

Playing at Random — Random Play

The tracks of the loaded MD will play at random.

1 Load an MD.

- If the current playing source is not the MD recorder, press MD ▷ / ■, then ■ before going to the next step.

2 Press PLAY/REC MODE (or PLAY MODE on the remote control) repeatedly until “MD RANDOM” appears in the main display.

The RANDOM indicator also lights.

- Each time you press the button, play mode changes as follows:

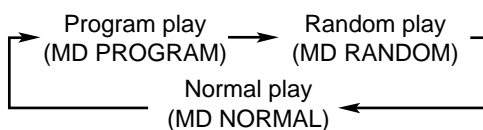

3 Press MD ▷ / ■.

The tracks are played at random.

Random play ends when all the tracks are played once.

To skip the playing track, push the joy control rightward (▶▶| >) or press ▶▶| on the remote control.

- You cannot go back to the previous tracks by pushing the joy control leftward (◀◀| <) or pressing ◀◀| on the remote control.

To stop during play, press ■.

- Random play also stops when you eject the MD.

To exit from Random play mode, press PLAY/REC MODE (or PLAY MODE on the remote control) once or twice, before or after play, so that the unit enters another playback mode (Normal play or Program play mode).

- Pressing one of the number buttons will start Normal play from the selected track.

Repeating Tracks — Repeat Play

You can have all the tracks, the program or the individual track currently playing repeat as many times as you like.

On the remote control ONLY:

To repeat play, press REPEAT during or before playing. Each time you press the button, Repeat play mode changes and appears in the main display as follows:

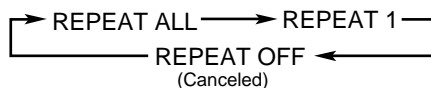

Ex. When “REPEAT ALL” is selected

REPEAT ALL: Repeats all the tracks in the MD (in Normal play or Random play mode), or all the tracks in the program.

REPEAT 1: Repeats one track.

REPEAT OFF: Cancels the repeat play.

Prohibiting Disc Ejection — Disc Lock

You can prohibit CD and MD ejection from the unit and can lock discs.

On the unit ONLY:

To prohibit disc ejection, press ▲ for the CD 1 tray while holding ■ with the unit set in standby mode.

“LOCKED” appears for a while, and the loaded discs (both CDs and MD) are locked.



If you try to eject the locked discs

“LOCKED” appears to inform you that the Disc Lock is in use.

To cancel the prohibition and unlock the discs, press ▲ for the CD 1 tray while holding ■ with the unit set in standby mode.

“UNLOCKED” appears for a while, and the loaded discs (both CDs and MD) are unlocked.

The buttons and controls enlarged in the illustration below are used and explained in this section (pages 33 to 37).

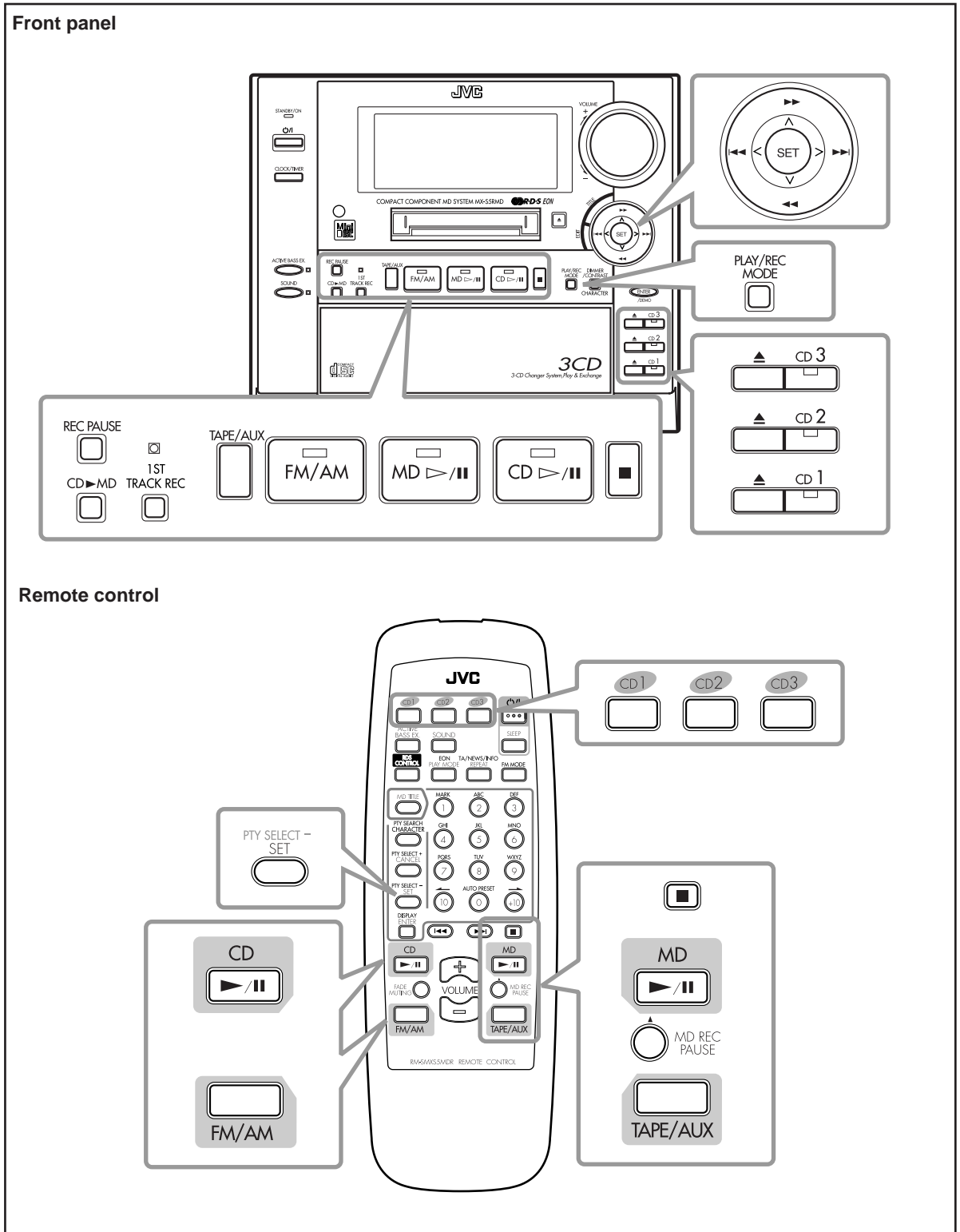

Before You Start Recording

- **It should be noted that it may be unlawful to re-record pre-recorded tapes, records, or discs without the consent of the owner of copyright in the sound or video recording, broadcast or cable programme and in any literary, dramatic, musical, or artistic embodied therein.**
- The sampling frequency rate converter built in the MD recorder allows you to record a digital source if its sampling frequency is 32 kHz, 44.1 kHz, or 48 kHz. If no source equipment is connected to the AUX terminal or if the sampling frequency of the connected equipment is not 32 kHz, 44.1 kHz, or 48 kHz, "AUX DIGITAL UNLOCK" appears in the main display (no recording is possible).
- You cannot record the entire Dolby Digital, DTS Digital Surround, or MPEG Multichannel signals through the AUX terminal.
- When you record onto partially recorded MD, its contents are not erased or overwritten. The recording starts from the point following the last recorded track of the MD.
If you want to record on such an MD from the beginning, you have to erase its contents first (see "ALL ERASE Function" on page 43).
- The recording level is automatically set correctly (except when recording from the equipment connected to the TAPE jacks), so it is not affected by the VOLUME control. Thus, during recording you can adjust the sound you are actually listening to without affecting the recording level.
- While recording, you can hear sound mode effect and/or the active bass extension effect through the speakers or headphones. However, the sound is recorded without these effects (see pages 15 and 16).

About the track marks

When playing an MD, you can move among the tracks. You can do this because there is a mark recorded at the beginning of each track enabling you to locate the track. This mark is called a "track mark" and the portion between two adjacent track marks is called a "track."

- **When recording from an analog source such as FM/AM broadcasts, no track mark is recorded on the MD.** This means that, when playing this MD, the MD recorder will regard the entire recording as one track (track 1). You will not be able to select directly a song or navigate through songs.

However, if there is a blank of 3 seconds or more, the MD recorder will consider it as a blank separating 2 tracks and consequently put a track mark.

To put a track mark manually while recording an analog source, press SET at the place you want to put a track mark.

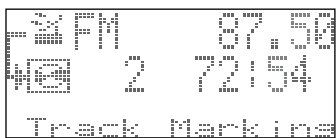

EX. When pressing SET while recording an FM broadcast program

To add a track mark after recording is over, you can use the DIVIDE function (see page 40).

To avoid erasing important recordings

The recordable MD has an erasure prevention tab so that important recordings are not accidentally erased. When you finish recording or editing, slide to open the erasure prevention tab on the cartridge side surface. New recording or editing is now no longer possible. (If you try to do, "DISC PROTECTED" appears in the main display.) To do re-recording or editing, return the tab to the closed position.

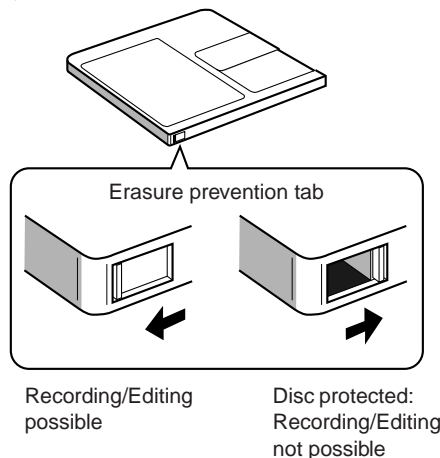

If "PLAYBACK DISC" appears in the main display when you try to record on an MD

The MD is only for playback use, not for recording.

Recording Any Sound Source — Standard Recording

The following recording method can be applied to any sound source.

1 Insert a recordable MD in the MD loading slot.

2 Select the source.

- **When recording a CD:**
Press CD 1, CD 2, or CD 3 to select a disc you want to record from, then ■.
- **When recording an FM/AM (MW/LW) broadcast:**
Press FM/AM, then tune into a station you want.

When the source for recording is FM or AM (MW/LW), you can select one of the two recording methods — Stereo Recording and Monaural Recording. (See page 36 for more details.)

- **When recording from external equipment:**
Press TAPE/AUX to select it as the playback source.

When the source for recording is “TAPE,” you can select the sound input level. See “To select the sound input level” to the right.

3 Press REC PAUSE on the unit (or MD REC PAUSE on the remote control).

The recording lamp on the unit starts flashing.

4 Press MD ▷ / ■.

The recording lamp stops flashing and remains lit, and recording starts.

- **When recording an FM/AM (MW/LW) broadcast:**
The station frequency will be recorded as the track title.

5 When recording a CD:

Press CD ▷ / ■.

When recording from external equipment:
Start playback.

- For details, see the manual supplied with your equipment.

To stop recording for a moment, press REC PAUSE (or MD REC PAUSE) again.

To resume recording, press MD ▷ / ■ again.

To stop recording, press ■. “WRITING” appears for a while.

- When recording from a CD, both the CD player and the MD recorder stop.



You can use more useful and easier recording methods

- For recording from CDs, “Recording CDs” on page 35.
- For recording FM/AM broadcasts, “Recording FM/AM (MW/LW) Broadcasts — Monaural Recording and Stereo Recording” on page 36.
- For recording from the external equipment, “Recording the External Equipment — Sound Synchronized Recording and Stereo Recording” on page 36.

To select the sound input level

This is only used for recording from an analog source (ex. tape or VCR) connected to the TAPE jacks on the rear. If the recorded sound from such an analog source is not loud enough, or if it is distorted, select the appropriate sound input level before recording.

On the unit ONLY:

1 While “TAPE” is selected as the source to play, press and hold PLAY/REC MODE until “TAPE INPUT” appears in the main display.



2 Push the joy control upward (▶▶ ^) or downward (◀◀ v) to select the recording input level, then press SET.

- “Level 1”: Select when the recorded sound is distorted. This setting reduces the input signal level. (Initial setting when shipped from the factory)
- “Level 2”: Select when the recorded sound is not loud enough. This setting increases the input signal level.

Recording CDs

You have two methods to record from a CD onto an MD.

- **Synchronized Recording** — Records the entire CD or the program you have made.
- **First Track Recording** — Records the first track of each CD.

Synchronized Recording

This is the easiest way of CD recording. At a press of the button, you can start playing a CD and recording on an MD.

On the unit ONLY:

- 1 Insert a recordable MD into the MD loading slot.**
- 2 Prepare a CD.**
 - Place a CD on one of the disc tray (CD 1, CD 2, or CD 3), press the corresponding disc number button (CD 1, CD 2, or CD 3), then **■** before going to the next step. Make sure that the correct disc number lamp lights on the unit.
 - You can make a program if you want (see page 26).
- 3 Press CD ► MD.**
The recording lamp on the unit lights, and recording starts.

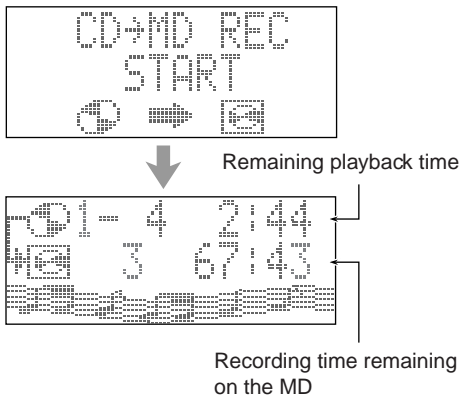

When recording ends, both the CD player and the MD recorder stop automatically.

To stop recording, press **■**. “WRITING” appears for a while.

Both the CD player and the MD recorder stop.

To record a single track during play or pause

Press CD ► MD while playing back or pausing a CD track you want to record.

The playback of that CD track is stopped, and the same track starts playing from the beginning again. This time, the MD recorder starts recording the CD track.

- When the track is recorded, both the CD player and the MD recorder stop.

First Track Recording

First Track Recording allows you to record the first track of each loaded CD. You can, for example, make a directory of all your best CDs.

On the unit ONLY:

- 1 Insert a recordable MD into the MD loading slot.**
- 2 Prepare a CD.**
 - Always place a CD on the CD 1 tray. If not, this function does not work.
- 3 Press 1ST TRACK REC.**
The recording lamp on the unit lights, and First Track Recording starts from the CD on the CD 1 tray.

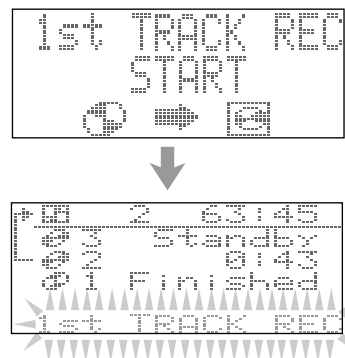

When the first track of the CD on the CD 1 tray is recorded, the first track of the CD on the CD 2 tray will be recorded. Recording continues until the first track of each loaded CD is recorded.

- 4 Replace the CDs on the trays whose disc number lamp is not lit green.**

- You can change CDs to continue the First Track Recording using more than 3 CDs.

When the first track of the last loaded CD is recorded, First Track Recording stops.

To stop recording, press **■**. “WRITING” appears for a while.

Both the CD player and the MD recorder stop.

Recording FM/AM (MW/LW) Broadcasts — Monaural Recording and Stereo Recording

When recording FM/AM (MW/LW) broadcasts, you can select one of the two recording methods — Monaural (Long) Recording and Stereo (Normal) Recording.

- **Monaural (Long) Recording** — Records both stereo program and monaural program in monaural. This allows you to record on an MD twice as long as the MD's recording time (indicated on the package of the MD). For example, you can record a 120-minute program on a 60-minute MD, though recorded sound becomes monaural. (Reproduced sound through the speakers during Monaural recording also becomes monaural.)
- **Stereo (Normal) Recording** — Sound is recorded in stereo (both on the left and right audio channels). You can also use the Standard Recording method described on page 34 for Stereo Recording.

- 1 Insert a recordable MD into the MD loading slot.
- 2 Press FM/AM, then tune into a station you want.
 - See "Tuning in a Station" on page 18.
- 3 Select the recording method — Monaural Recording or Stereo Recording.

- 1) Press PLAY/REC MODE on the unit.



- 2) Push the joy control upward (▶▶ ^) or downward (◀◀ v) to select the recording method you want, then press SET.

The recording lamp on the unit starts flashing.

- STEREO: Select for normal stereo recording
- MONO: Select for a long monaural recording

Ex. When selecting "MONO"

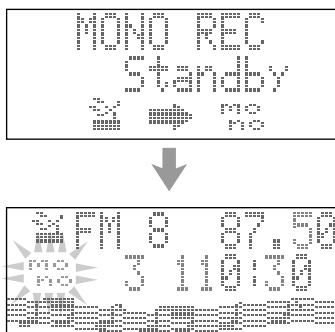

Ex. When selecting "STEREO"

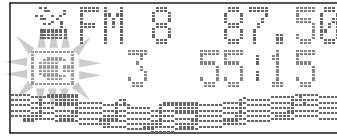

- 4 Press MD ▷ / ||.

The recording lamp stops flashing and remain lit, and recording starts.

- The station frequency will be recorded as the track title.

To stop recording, press ■.

To stop recording for a moment, press REC PAUSE (or MD REC PAUSE on the remote control) again.

To resume recording, press MD ▷ / || again.



In the following cases, Monaural Recording is automatically canceled, and Stereo Recording resumes.

- When you turn off, then on the unit.
- When you change the source.
- When you eject the MD.
- When you change the band (FM or AM). If you change the stations but not change the band, Monaural Recording is not canceled.

Recording the External Equipment — Sound Synchronized Recording and Stereo Recording

When recording from the external equipment, you can select one of the two recording methods — Sound Synchronized Recording and Stereo (Normal) Recording.

When the sound signal comes in through the AUX terminal, digital recording is performed.

- **Sound Synchronized Recording** — With this recording method, you can start recording automatically when the source sound comes into this unit through the TAPE jacks or the AUX terminal. Sound Synchronized Recording will stop automatically if no sound comes in for more than 30 seconds. Sound is recorded in stereo.
- **Stereo (Normal) Recording** — Sound is recorded in stereo (both on the left and right audio channels). You can also use the Standard Recording method described on page 34 for Stereo Recording.

1 Insert a recordable MD into the MD loading slot.

2 Press TAPE/AUX to select the sound source you want to record from.

- When selecting “TAPE,” the sound input level appears for a while. (See page 34 for the sound input level.)

3 Select the recording method — Sound Synchronized Recording or Stereo Recording.

1) Press PLAY/REC MODE on the unit.



2) Push the joy control upward (▶▶ ^) or downward (◀◀ v) to select the recording method you want, then press SET.

The recording lamp on the unit starts flashing.

- STEREO: Select for normal stereo recording
- SOUND SYNC: Select for a sound synchronized recording

Ex. When selecting “SOUND SYNC” for recording from a tape

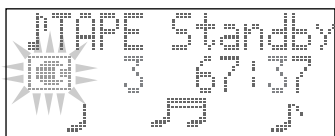
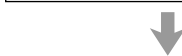

Ex. When selecting “STEREO” for recording from a tape

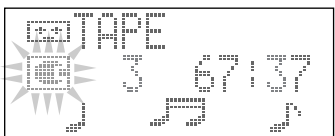

4 When selecting “SOUND SYNC”:

Start playback on the external equipment.

The recording lamp stops flashing and remains lit, and recording starts automatically.

When selecting “STEREO”:

1) Press MD ▷ / II.

The recording lamp stops flashing and remain lit, and recording starts.

2) Start playback on the external equipment.

To stop recording, press ■.

To stop recording for a moment (only for Stereo

Recording), press REC PAUSE (or MD REC PAUSE on the remote control) again.

To resume recording, press MD ▷ / II.



When the source for recording is “TAPE” you can select the sound input level. See “To select the sound input level” on page 34.



When recording is stopped or finished Sound Synchronized Recording is automatically canceled, and Stereo Recording resumes.



If Sound Synchronized Recording will not work correctly

Use the Stereo (Normal) Recording or Standard Recording method (see page 34).

Sound Synchronized Recording starts automatically when this unit detects sound signals come in. This means that, if sound signal is too weak for this unit to detect, Sound Synchronized Recording will not start (or will stop even while the source is being played).



When recording from a DAT deck using Sound Synchronized Recording

Two track marks will be recorded at the beginning of the recording. If this occurs, join these two track marks using the JOIN function described on page 41.

The buttons and controls enlarged in the illustration below are used and explained in this section (pages 39 to 43).

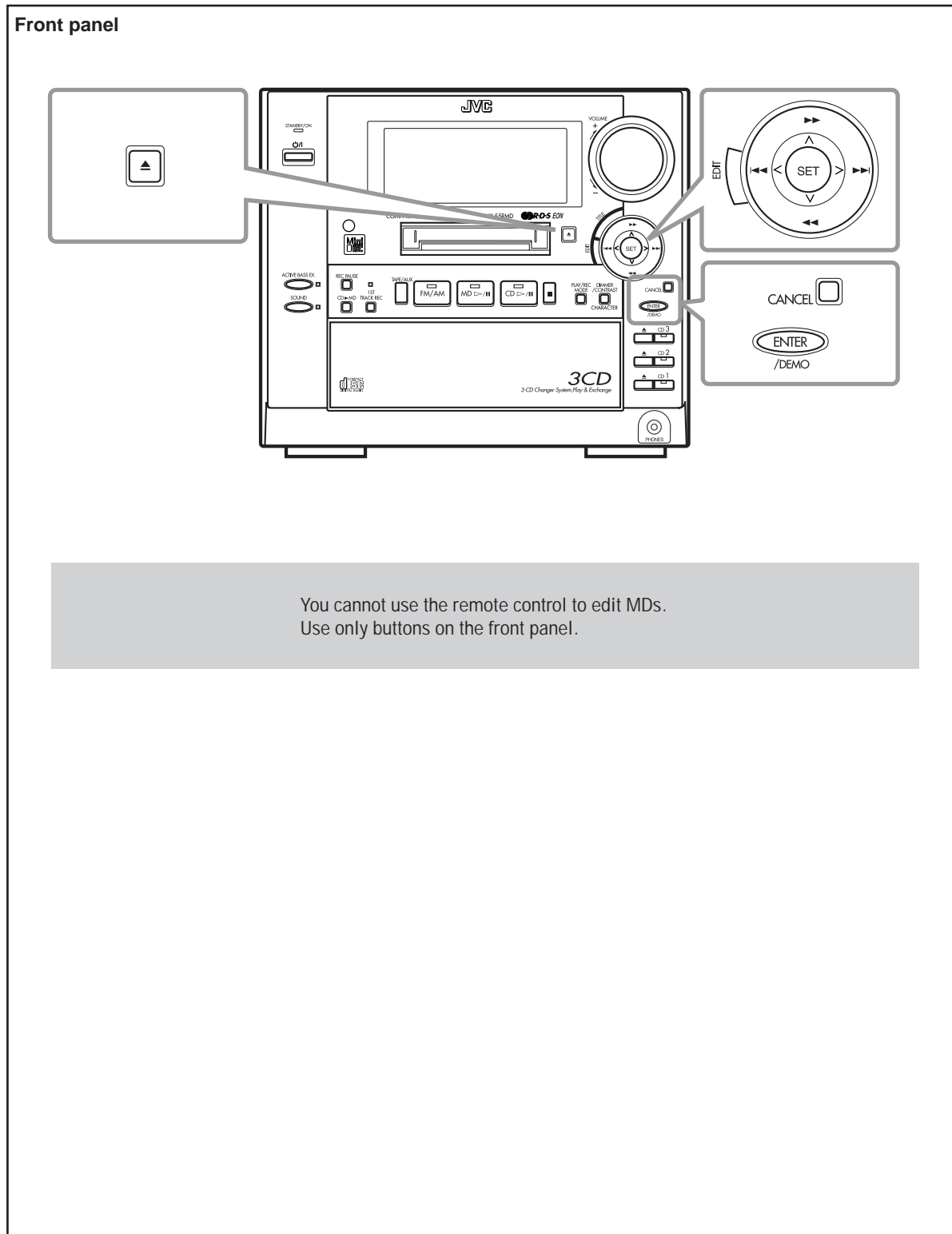

You cannot use the remote control to edit MDs.
Use only buttons on the front panel.

Introducing MD Editing Functions

A recorded MD can be edited in many ways. The MD editing functions include dividing, joining, moving, erasing tracks, erasing the entire disc, and more than one of them can be combined as required.

Dividing a track (DIVIDE) : Page 40

This function divides a track by adding a track marking(s) in the desired point(s) in the middle or where you want to search later.

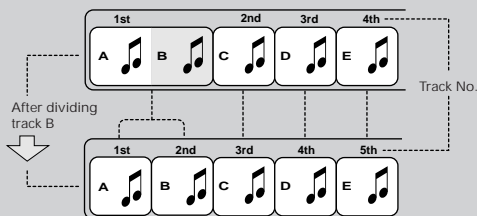

Joining a track (JOIN) : Page 41

This function joins two adjacent tracks into a single track by deleting a track marking.

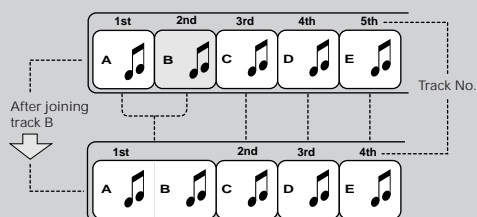

Moving a track (MOVE) : Page 41

This function moves a track by reordering the track numbers.

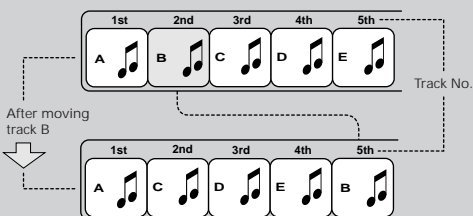

Erasing a track (ERASE) : Page 42

This function erases selected tracks. After the erasure, the subsequent tracks are justified and their track numbers are renumbered automatically. You can erase up to 15 tracks at a time.

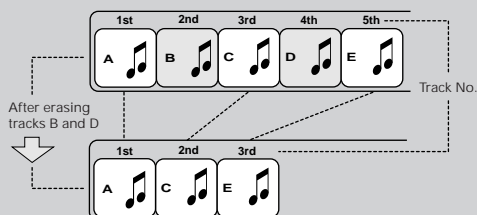

Erasing all tracks (ALL ERASE) : Page 43

This function erases data in a disc entirely.

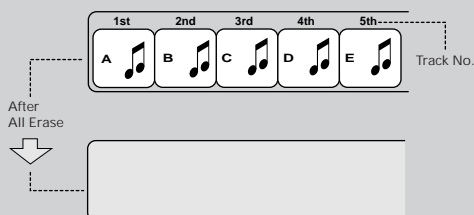

Erasing a Portion of a Track

By combining "DIVIDE", "ERASE" and "JOIN", for example, it is possible to erase only a part of an existing track.

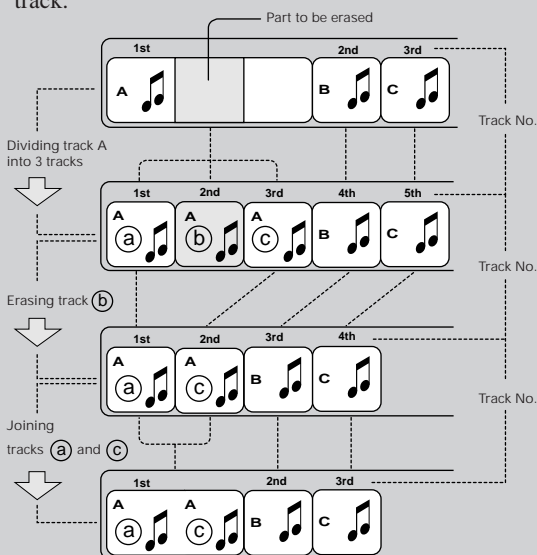

notes If "PLAYBACK DISC" or "DISC PROTECTED" appears when you try to edit an MD You cannot edit such MDs. See page 58.

notes You can also assign titles to MDs and/or tracks (See page 44.)

A title can be assigned to a track or disc. Once a title is assigned, it is displayed in later playback for confirmation. Each title can be composed of up to 64 characters, and can be input using alphabetic characters (uppercase and lowercase), symbols and numerals.

DIVIDE Function

This function allows you to divide one track into two separate tracks. It is useful, for example, when you want to add track marks at a certain point within a track or if you want to separate a recording.

- To stop any time during editing process, press EDIT.

On the unit ONLY:

1 Insert an MD you want to edit into the MD loading slot.

2 Press EDIT.

The source is changed to “MD,” and the MD recorder enters editing mode (with DIVIDE function selected).

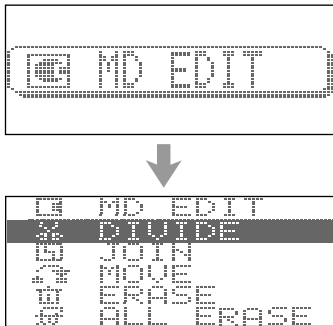

3 Press SET.

The first track (or the current track) start playing.

4 Push the joy control rightward (▶▶| >) or leftward (|◀◀ <) to select the track you want to divide.

The selected track starts playing.

Ex. When you want to divide track 5

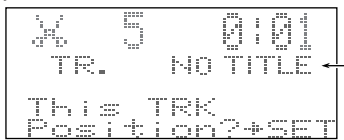

If the track has a title, it is show here.

- If you do not push the joy control rightward (▶▶| >) or leftward (|◀◀ <), the same track plays repeatedly.
- You can push the joy control upward (▶▶ ^) or downward (◀◀ v) to find the dividing point.

5 Press SET when you find the point where you want to divide the track.

The MD recorder repeats the selected point — a 3-second period following the dividing point.

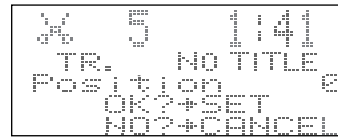

- If the dividing point is satisfactory, go to step 7.
- If the dividing point is not satisfactory, go to the next step.

6 Push and hold the joy control rightward (▶▶| >) or leftward (|◀◀ <) to precisely adjust the dividing point.

- You can shift the dividing point up to ± 128 . This range (± 128) corresponds to approximately ± 8 seconds from the original point (Position 0).



Ex. When adjusting the point by +20

When you stop holding the joy control, the unit repeats the newly selected dividing point.

- When you find the right position, go to the next step.
- If you want to cancel the dividing point, press CANCEL, then select the correct dividing point.

7 Press SET.

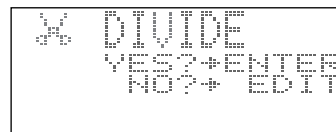

8 Press ENTER/DEMO to finish the editing procedure.

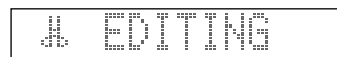

9 Press Δ for the MD recorder to eject the MD.

“WRITING” appears while the editing you have made is being recorded on the MD.

To join the divided tracks again, see the JOIN function.

JOIN Function

This function allows you to join two adjacent tracks into one track.

- To stop any time during editing process, press EDIT.

On the unit ONLY:

1 Insert an MD you want to edit into the MD loading slot.

2 Press EDIT.
The source is changed to "MD," and the MD recorder enters editing mode (with DIVIDE function selected).

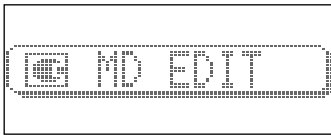

- If "JOIN" is not shown ("----" appears instead), you cannot join the tracks.

3 Push the joy control downward (◀◀ ∨) or upward (▶▶ ^) to select "JOIN," then press SET.

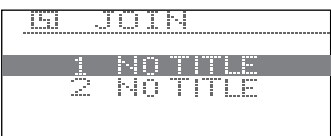

4 Push the joy control downward (◀◀ ∨) or upward (▶▶ ^) to select the two adjacent tracks you want to join.



Ex. When you want to join tracks 2 and 3

5 Press SET.



- If you have selected wrong tracks, press CANCEL, then select the correct tracks.

6 Press ENTER/DEMO to finish the editing procedure.

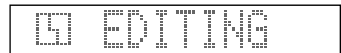

7 Press ▲ for the MD recorder to eject the MD.
"WRITING" appears while the editing you have made is being recorded on the MD.

To divide the joined tracks, see the DIVIDE function.

MOVE Function

This function allows you to move a track to the position you prefer. It is useful to change the order of the tracks as you like.

- To stop any time during editing process, press EDIT.

On the unit ONLY:

1 Insert an MD you want to edit into the MD loading slot.

2 Press EDIT.
The source is changed to "MD," and the MD recorder enters editing mode (with DIVIDE function selected).

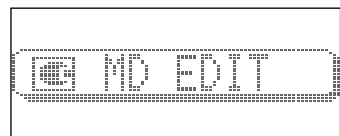

- If "MOVE" is not shown ("----" appears instead), you cannot move the tracks.

3 Push the joy control downward (◀◀ ∨) or upward (▶▶ ^) to select “MOVE,” then press SET.



4 Push the joy control downward (◀◀ ∨) or upward (▶▶ ^) to select the track you want to move.

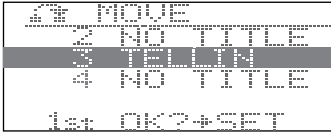

Ex. When you want to move track 3

5 Press SET.

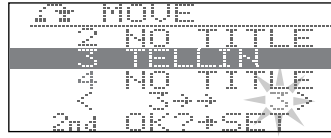

- If you have selected a wrong track number, press CANCEL, then select the correct track number.

6 Push the joy control downward (◀◀ ∨) or upward (▶▶ ^) to select the position where you want to move the track.

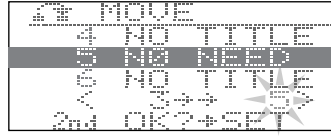

Ex. When you want to move to the track 5 position

7 Press SET.

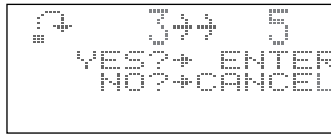

- If you have selected wrong tracks, press CANCEL, then select the correct tracks by repeating from step 4.

8 Press ENTER/DEMO to finish the editing procedure.



9 Press ▲ for the MD recorder to eject the MD. “WRITING” appears while the editing you have made is being recorded on the MD.

ERASE Function

This function allows you to erase an unwanted track.
 • To stop any time during editing process, press EDIT.

On the unit ONLY:

1 Insert an MD you want to edit into the MD loading slot.

2 Press EDIT.

The source is changed to “MD,” and the MD recorder enters editing mode (with DIVIDE function selected).

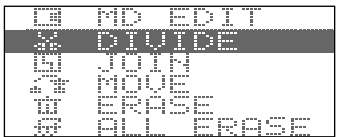
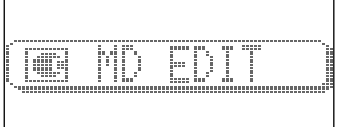

3 Push the joy control downward (◀◀ ∨) or upward (▶▶ ^) to select “ERASE,” then press SET.

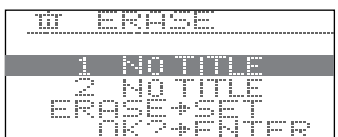

- 4** Push the joy control downward (◀◀ ∨) or upward (▶▶ ^) to select the track you want to erase.

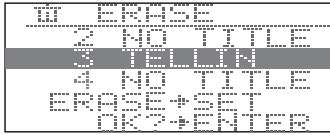

- 5** Press SET.

“x” appears between track number and track title. “x” means the track in the same line will be erased when you finish the editing procedure.

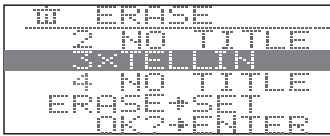

Ex.: When you want to erase track 3

- If you have selected a wrong track number, press CANCEL, then select the correct track number.

- 6** Repeat step 4 and 5 to select all the track you want to erase.

- You can select up to 15 tracks.

- 7** Press ENTER/DEMO to finish selecting tracks.

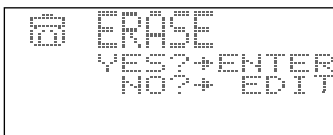

- 8** Press ENTER/DEMO to finish the editing procedure.



- 9** Press ▲ for the MD recorder to eject the MD.

“WRITING” appears while the editing you have made is being recorded on the MD.

ALL ERASE Function

This function allows you to erase all the tracks on an MD.

- To stop any time during editing process, press EDIT.

On the unit ONLY:

- 1** Insert an MD you want to edit into the MD loading slot.

- 2** Press EDIT.

The source is changed to “MD,” and the MD recorder enters editing mode (with DIVIDE function selected).

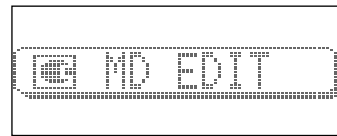

- 3** Push the joy control downward (◀◀ ∨) or upward (▶▶ ^) to select “ALL ERASE,” then press SET.



- 4** Press ENTER/DEMO to erase all tracks and finish the editing procedure.

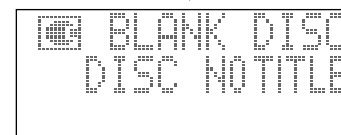

- 5** Press ▲ for the MD recorder to eject the MD.

“WRITING” appears while the editing you have made is being recorded on the MD.

Making Your Own Titles and Screens

Continued 

The buttons and controls enlarged in the illustration below are used and explained in this section (pages 45 to 49).

Front panel

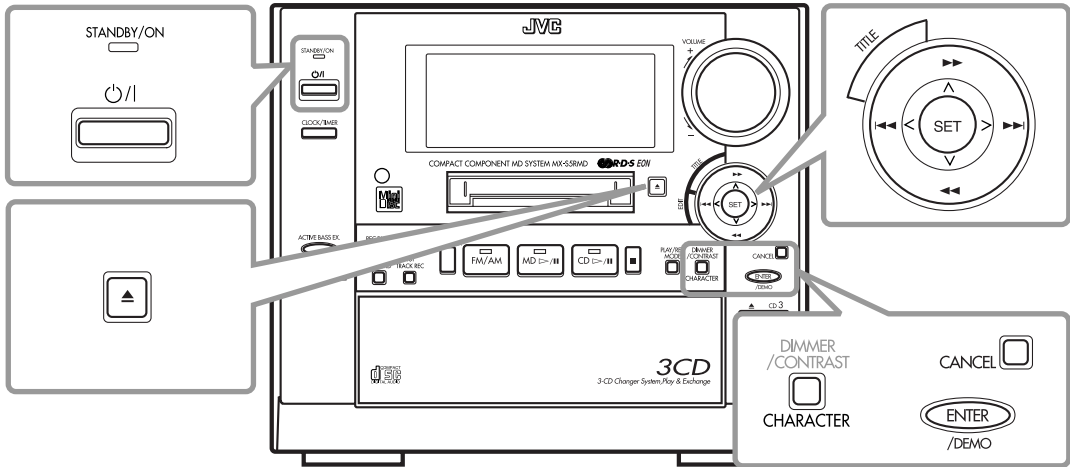

Remote control

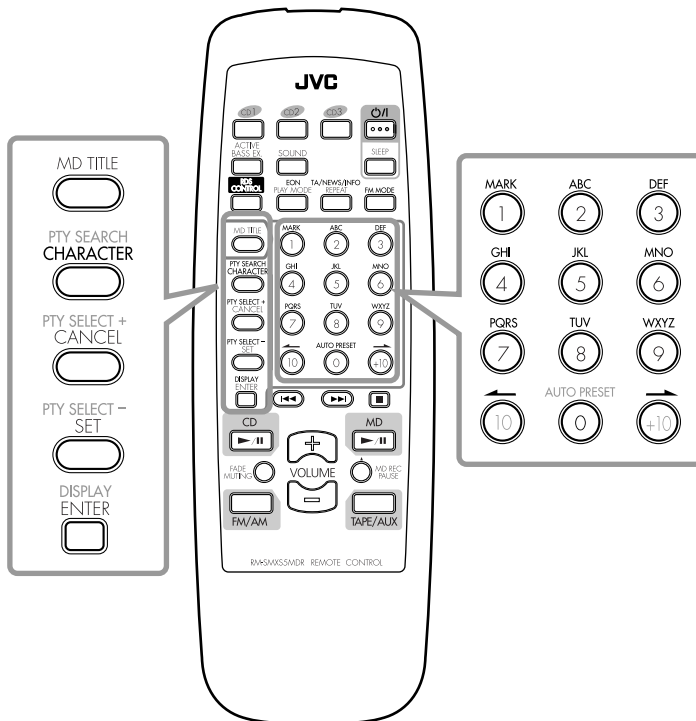

Assigning Titles to an MD

You can assign a name to each MD and to each track. Once a title is assigned, it is displayed for your confirmation.

Each title can be composed of up to 64 characters, and can be input using alphabetic characters (uppercase and lowercase), symbols and numerals.

On the unit:

In the following example, the process is explained from the very first — that is, inserting a disc. If you already start recording or playing, start from step 2.

- To exit from the title entry screen any time during the process, press TITLE.

1 Insert an MD you want to edit into the MD loading slot.

2 Press TITLE.

The source is changed to “MD,” and the MD recorder enters one of the following title entry screen.

- Disc title entry screen:** appears when you press TITLE when the MD recorder stops.

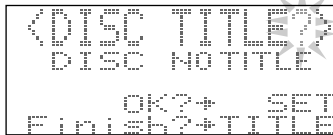
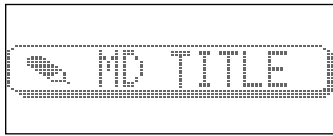

- Track title entry screen:** appears when you press TITLE while playing or recording.

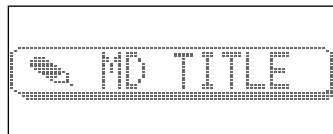

Ex. While playing track 1

3 Push the joy control rightward (▶▶|>) or leftward (◀◀|<) to change the title entry mode.

- Title entry mode changes as follows:

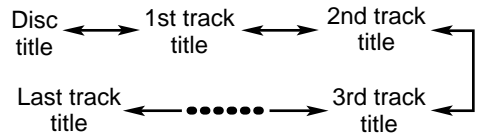

4 Press SET to enter the selected title entry mode.

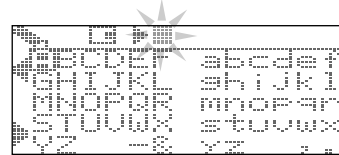

Ex. When entering a disc title

5 Press CHARACTER to select the character set you want.

- Each time you press the button, the character sets change as follows:

Alphabets ↔ Numerals & Symbols

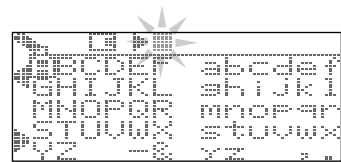

Alphabets

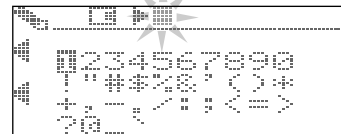

Numerals and symbols

6 Input a character.

- Ex. When entering "H"

- 1) Push the joy control horizontally (←← < / > >>>) and vertically (←← ∨ / >>> ∧) to until "H" is selected.

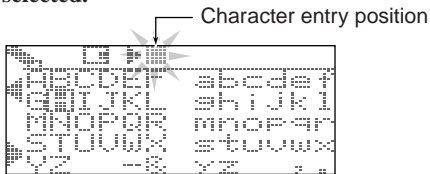
**2) Press SET.**

The selected character is entered, and the character entry position moves to the next.

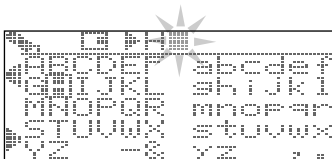

- To move the character entry position while entering a title, select ► for moving it rightward and ◀ for moving it leftward in the main display, then press SET. Each time you press SET, the character entry position moves.
- To enter a blank, select a blank in the main display, then press SET.
- If you have entered an incorrect character, press CANCEL to cancel the last entry.

7 Repeat steps 5 and 6 to enter other characters.

- The main display can only show 8 characters at a time. If you enter the 9th character, the first character disappears, and so on.

8 Press ENTER/DEMO to finish the current title entry.

"EDITING" appears for a while, then the unit enters title entry mode again.

- You can assign another title by repeating steps 3 to 8.

9 Press TITLE (or ENTER/DEMO again) to exit from the title entry mode.**10 Press ▲ for the MD recorder to eject the MD.**

"WRITING" appears while the editing you have made is being recorded on the MD.



You can assign titles during play or recording

- **During play:**

- **Entering a track title**

The MD recorder repeats playback of the current track until you press ENTER/DEMO in step 8 above. When you press ENTER/DEMO, the next track will be played.

- **Entering a disc title**

The MD recorder repeats playback of all tracks of the MD until you press ENTER/DEMO in step 8 above. When you press ENTER/DEMO, the MD recorder enters the track title entry mode.

- **During recording:**

- **Entering a track title**

The MD recorder continues recording even after you press ENTER/DEMO in step 8 above. When you press ENTER/DEMO, a track title is assigned to the track where you have started the title entry.

- **During CD Synchronized Recording and the First Track Recording:**

You can assign the disc title, and 15 track titles one after another as recording goes on. The track titles you have entered are automatically assigned to the tracks recorded on the MD in sequential order. If you enter 16th track title or more, they are ignored.



If "NO OPERATION!" appears

You have tried to use the remote control while entering a title using the buttons on the unit. Use the buttons on the unit only.

Changing the Title

You can make a correction or change the title.

- 1 Follow steps 1 to 4 of page 45.
- 2 Push the joy control horizontally (←← < / →→ >) and vertically (←← ∨ / →→ ∧) to select the character you want to correct.
 - Make sure that the character you want to change is flashing.
- 3 Press CANCEL to delete the character you have selected in the above step.
- 4 Input the correct character.
 - 1) Press CHARACTER to select the character set you want.
 - 2) Push the joy control horizontally (←← < / →→ >) and vertically (←← ∨ / →→ ∧) to select the correct character, then press SET.
- 5 Repeat steps 2 to 4 of the current procedure to correct more characters.
- 6 Press ENTER/DEMO to finish correcting the title.
 - If you want to correct another title, select another title entry mode by pushing the joy control rightward (→→ >) or leftward (←← <), press SET, then repeat from step 2 above.
 - If you want to finish the correction, go to the next step.
- 7 Press TITLE (or ENTER/DEMO again) to exit from the title entry mode.
- 8 Press ▲ for the MD recorder to eject the MD. “WRITING” appears while the editing you have made is being recorded on the MD.

To erase all the characters

Press CANCEL repeatedly in step 3 above to erase all the characters, then go to step 6.

On the remote control:

In the following example, the process is explained from the very first — that is, inserting a disc. If you already start recording or playing, start from step 2.

- To exit from the title entry screen any time during the process, press MD TITLE.

- 1 Insert an MD you want to edit into the MD loading slot.

- 2 Press MD TITLE.

The source is changed to “MD,” and the MD recorder enters one of the following title entry screen.

- **Disc title entry screen:** appears when you press MD TITLE when the MD recorder stops.

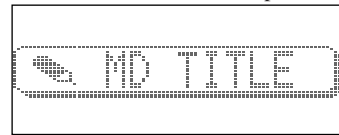

- **Track title entry screen:** appears when you press MD TITLE while playing or recording.

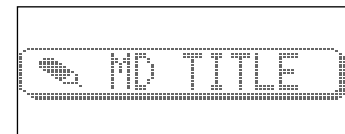

- 3 Press ← (10) or → (+10) to change the title entry mode.

- Title entry mode changes as follows:

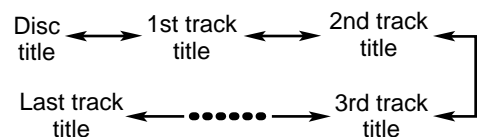

4 Press SET to enter the selected title entry mode.

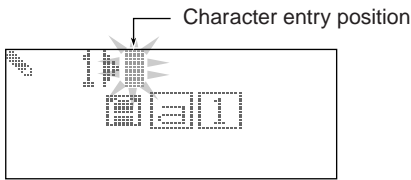

5 Press CHARACTER to select the character set you want.

- Each time you press the button, the character sets change as follows:

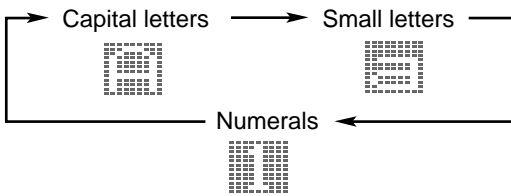

6 Input a character.

1) Press the character entry button for a character you want to input.

Examples:

- To input an “A” or “a,” press ABC once.
To input a “B” or “b,” press ABC twice.
To input a “C” or “c,” press ABC three times.
- To input a symbol, press MARK repeatedly until the mark you want appears.
- To input a numeral, press 0 – 9.
- To move the character entry position while entering a title, press ← (10) or → (+10).
- If you have entered an incorrect character, press CANCEL to cancel the last entry.

2) Press the button for the next character you want to input.

- If the next character you want to input is assigned to the same button you have just pressed in step 6-1), press → (+10) first to move the character entry position to the right.

7 Repeat steps 5 and 6 to enter other characters.

- The main display can only show 8 characters at a time. If you enter the 9th character, the first character disappears, and so on.

8 Press ENTER to finish the current title entry.

“EDITING” appears for a while, then the unit enters title entry mode again.

- You can assign another title by repeating steps 3 to 8.

9 Press MD TITLE (or ENTER again) to finish the title entry.

10 Press ▲ for the MD recorder to eject the MD.

“WRITING” appears while the editing you have made is being recorded on the MD.



Available Symbols are as follows:

(Blank)	!	"	#	\$	%	&	'	()
*	+	,	-	.	/	:	;	< =
>	?	@	_	\				



You can assign titles during play or recording

• **During play:**

Entering a track title

The MD recorder repeats playback of the current track until you press ENTER in step 8 above. When you press ENTER, the next track will be played.

Entering a disc title

The MD recorder repeats playback of all tracks of the MD until you press ENTER in step 8 above. When you press ENTER, the MD recorder enters the track title entry mode.

• **During recording:**

Entering a track title

The MD recorder continues recording even after you press ENTER in step 8 above. When you press ENTER, a track title is assigned to the track where you have started the title entry.

• **During CD Synchronized Recording and the First Track Recording:**

You can assign the disc title, and 15 track titles one after another as recording goes on. The track titles you have entered are automatically assigned to the tracks recorded on the MD in sequential order. If you enter 16th track title or more, they are ignored.



If “NO OPERATION!” appears

You have tried to use the buttons on the unit while entering a title using the remote control. Use the remote control only.

Changing the Title

You can make a correction or change the title.

- 1 Follow steps 1 to 4 of pages 47 and 48.
- 2 Press ← (10) or → (+10) to select the character you want to correct.
 - Make sure that the character you want to change is flashing.
- 3 Press CANCEL to delete the character you have selected in the above step.
- 4 Input the correct character by pressing one of the character entry buttons.
- 5 Repeat steps 2 to 4 of the current procedure to correct more characters.
- 6 Press ENTER to finish correcting the title.
 - If you want to correct another title, select another title entry mode by pressing ← (10) or → (+10), press SET, then repeat from step 2 above.
 - If you want to finish the correction, go to the next step.
- 7 Press MD TITLE (or ENTER again) to exit from the title entry mode.
- 8 Press ▲ for the MD recorder to eject the MD.
“WRITING” appears while the editing you have made is being recorded on the MD.

To erase all the characters

Press CANCEL repeatedly in step 3 above to erase all the characters, then go to step 6.

Creating Your Own Opening and Ending Screens

When you turn on or off the unit, you can show your own screens instead of the HELLO and SEE YOU screens. To create your own opening and ending screens, follow the procedure below.

- You can register up to 39 characters for each screen.

On the unit ONLY:

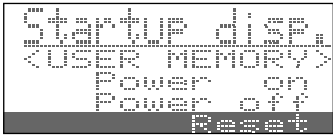
- 1 Press ⏻ to turn off the unit if it is on.
The STANDBY/ON lamp lights red.
- 2 Press and hold TITLE until “Startup disp.” (Startup display) appears in the main display.

- 3 Push the joy control downward (◀◀ ∨) or upward (▶▶ ^) to select the screen you want to make, then press SET.
Power on : To make your own opening screen
Power off : To make your own ending screen
Reset : See “To erase your own screen” below
- 4 Enter the message using the title entry procedure explained on pages 45 and 46.
- 5 Press ENTER/DEMO to finish creating the screen.
- 6 Repeat step 2 to 5 to create the other screen if you want.

To erase your own screen

Repeat the above procedure and in step 3, select “Reset.” “Startup disp. Reset!” appears in the main display, and your own screens are erased.

When you turn on and off the unit, the HELLO screen and the SEE YOU screen will appear.

- You cannot erase your own screens separately.

Using the Timers

Continued 

The buttons and controls enlarged in the illustration below are used and explained in this section (pages 51 to 54).

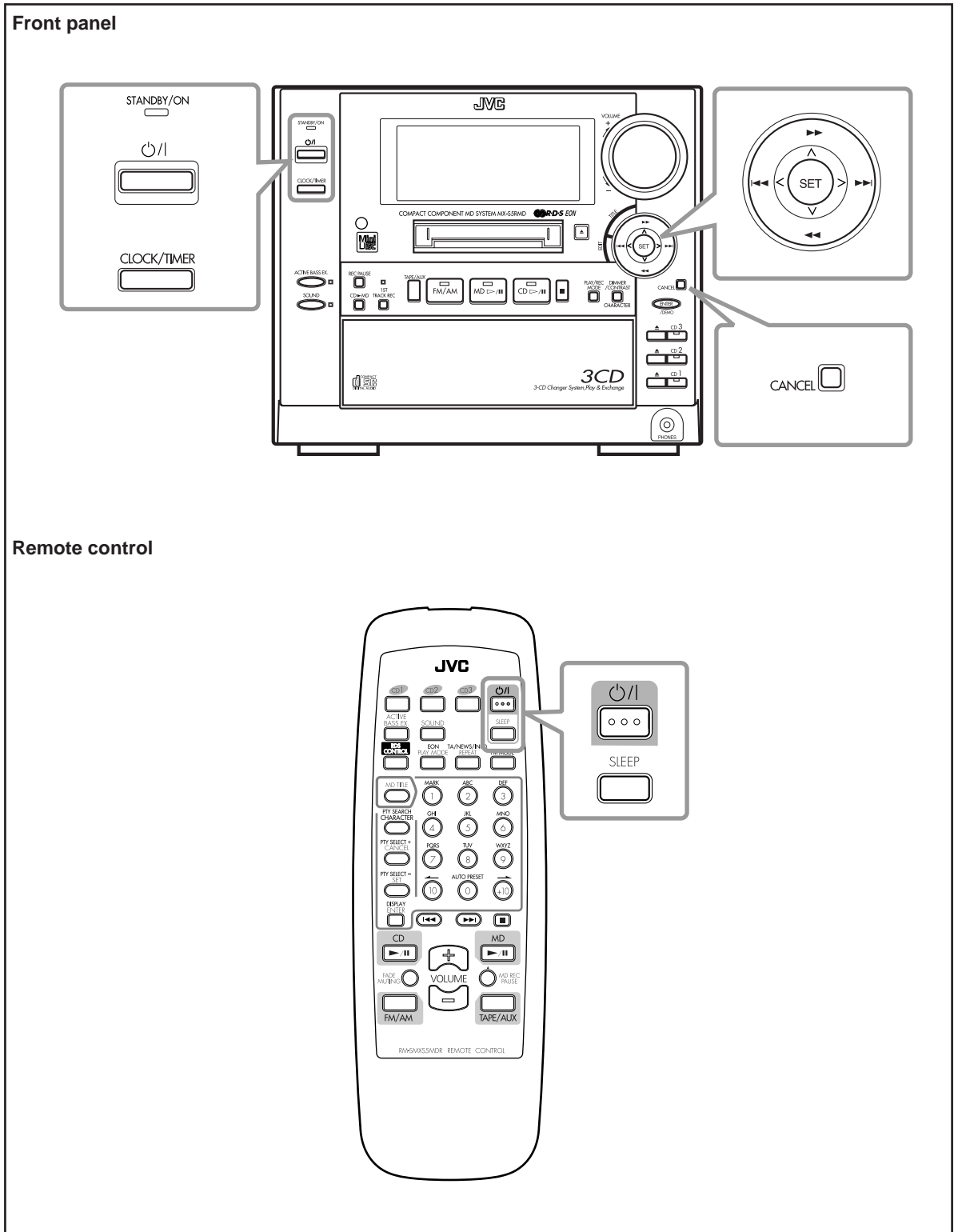

There are three timers available — Recording Timer, Daily Timer, and Sleep Timer.

Before using these timers, you need to set the clock built in the unit. (See page 11.)

Using Recording Timer

With Recording Timer, you can make an unattended recording.

- You can set Recording Timer whether the unit is tuned on or off.
- To correct a mis-entry any time during the setting process, press CANCEL. To cancel the setting any time during process, press CLOCK/TIMER.

How Recording Timer actually works

The unit automatically turns on, turns off the volume, and starts recording on the MD when the timer-on time comes. Then, when the timer-off time comes, the unit automatically turns off (stands by).

Recording Timer works only once, but the timer settings remain stored in memory until you reset them or disconnect the AC power cord.

On the unit ONLY:

- 1 Press **CLOCK/TIMER** repeatedly until “**REC TIMER SET UP**” appears in the main display. The REC indicator starts flashing on the display.

- Each time you press the button, the timer mode changes as follows:

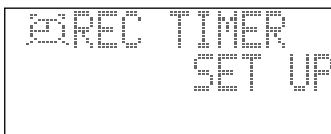
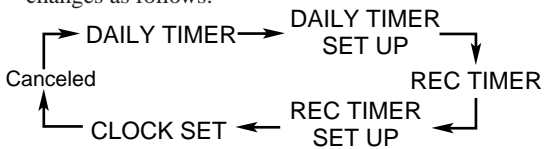

- 2 Push the joy control rightward (▶▶| >) or leftward (|◀◀ <) to set the hour of the timer-on time, then press SET.

- 3 Push the joy control rightward (▶▶| >) or leftward (|◀◀ <) to set the minute of the timer-on time, then press SET.

- 4 Push the joy control rightward (▶▶| >) or leftward (|◀◀ <) to set the hour of the timer-off time, then press SET.

- 5 Push the joy control rightward (▶▶| >) or leftward (|◀◀ <) to set the minute of the timer-off time, then press SET.

- 6 Push the joy control rightward (▶▶| >) or leftward (|◀◀ <) to select the source.

- The source changes as follows:



FM: Tunes into an FM station.

- Select a preset station (see below).

AM: Tunes into an AM (MW/LW) station.

- Select a preset station (see below).

TAPE*: Selects “TAPE” as the source.

- Make the external equipment ready for playback.

AUX DIGITAL*: Selects “AUX DIGITAL” as the source.

- Make the external digital equipment ready for playback.

* To operate these equipment with the Recording Timer, they also need to have the timer function.

- 7 **If you have selected “FM” or “AM” as the source in the above step, select a preset number.**

Push the joy control downward (◀◀ ∨) or upward (▶▶ ^) to select a preset station, then press SET.

- If you press SET without selecting a preset station, the last received station will be tuned in when the timer recording starts.

If you have selected “TAPE” or “AUX DIGITAL” as the source in the above step, simply press SET.

The REC indicator stops flashing, and remains lit.

8 If you have selected “FM” or “AM” as the source in the above step, select the recording mode.

Push the joy control rightward (▶▶|>) or leftward (|◀◀<) to select the recording mode — either Stereo Recording or Monaural Recording, then press SET. The REC indicator stops flashing, and remains lit.

9 Press to turn off the unit (on standby) if necessary.

To turn on or off Recording Timer after its setting is done

1 Press CLOCK/TIMER repeatedly until “REC TIMER” appears in the main display.



2 To turn off the Recording Timer, push the joy control downward (◀◀∨) to select “OFF,” then press SET.

The REC indicator goes off from the display. The Recording Timer is canceled, but the setting for the Recording Timer remains in memory.

To turn on the Recording Timer, press SET (after making sure that “ON” is selected in the main display).

The REC indicator lights on the display. The settings you have done are shown in the main display for your confirmation.



If you change the source or press CLOCK/TIMER while Recording Timer is operating

Recording Timer is canceled and the unit does not turn off automatically.

Using Daily Timer

With Daily Timer, you can wake up to your favorite music or radio program.

- You can set Daily Timer whether the unit is turned on or off.
- To correct a mis-entry any time during the setting process, press CANCEL.
- To cancel the setting any time during process, press CLOCK/TIMER.

How Daily Timer actually works

The unit automatically turns on, and starts playing the specified source when the timer-on time comes. Then, when the timer-off time comes, the unit automatically turns off (stands by).

Daily Timer works every day, and the timer settings remain stored in memory until you reset them or disconnect the AC power cord.

On the unit ONLY:

1 Press CLOCK/TIMER repeatedly until “DAILY TIMER SET UP” appears in the main display.

- Each time you press the button, the timer mode changes as follows:

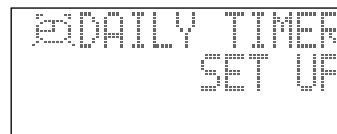
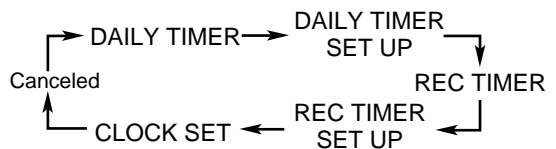

2 Push the joy control rightward (▶▶|>) or leftward (|◀◀<) to set the hour of the timer-on time, then press SET.

3 Push the joy control rightward (▶▶|>) or leftward (|◀◀<) to set the minute of the timer-on time, then press SET.

4 Push the joy control rightward (▶▶|>) or leftward (◀◀<) to set the hour of the timer-off time, then press SET.

5 Push the joy control rightward (▶▶|>) or leftward (◀◀<) to set the minute of the timer-off time, then press SET.

6 Push the joy control rightward (▶▶|>) or leftward (◀◀<) to select the source.

- The source changes as follows:

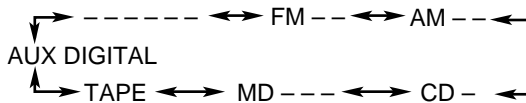

-----: Plays the source selected when the unit is turned off.

FM --: Tunes into an FM station.

→ go to step 7 to select a preset station.

AM --: Tunes into an AM (MW/LW) station.

→ go to step 7 to select a preset station.

CD -: Plays a CD.

→ Prepare a CD, then go to step 7 to select the CD and starting track.

MD ---: Plays an MD.

→ Prepare an MD, then go to step 7 to select the starting track.

TAPE*: Selects "TAPE" as the source.

→ Make the external equipment ready for playback.

AUX DIGITAL*: Selects "AUX DIGITAL" as the source.

→ Make the external digital equipment ready for playback.

* To operate these equipment with the Daily Timer, they also need to have the timer function.

7 If you have selected "FM --" or "AM --" as the source in the above step, select a preset station.

Push the joy control downward (◀◀∨) or upward (▶▶^) to select a preset station, then press SET.

- If you press SET without selecting a preset station, the last received station will be tuned in when the unit is turn on with the Daily Timer.

If you have selected "CD -" as the source in the above step, select a disc number.

- Push the joy control downward (◀◀∨) or upward (▶▶^) to select the disc number (CD 1 to CD 3), then press SET.
- Push the joy control downward (◀◀∨) or upward (▶▶^) to select a track number, then press SET.

- If you press SET without selecting a disc number, the last selected disc will be played back when the unit is turn on with the Daily Timer.
- If you press SET without selecting a track number, playback starts from the first track of the selected disc when the unit is turn on with the Daily Timer.

If you have selected "MD ---" as the source in the above step, select a track number.

Push the joy control downward (◀◀∨) or upward (▶▶^) to select a track number, then press SET.

- If you press SET without selecting a track number, the first track starts playing when the unit is turn on with the Daily Timer.

If you have selected "TAPE" or "AUX DIGITAL" as the source in the above step, simply press SET.

8 Push the joy control rightward (▶▶|>) or leftward (◀◀<) to adjust the volume level.

- You can adjust the volume level within the range of 0 (silent) to 50 (maximum).

- "--" can be selected if you set the timer while the unit is turned on. The volume is set to the current volume level.

9 Push the joy control downward (◀◀∨) or upward (▶▶^) to select volume fade-in mode — "FADE" or "NoFADE."

FADE: Volume fades in (gradually becomes louder and is set to the specified level).

NoFADE: No fade-in effect. Volume is set to the specified level when the timer-on time comes.

10 Press SET.

The DAILY indicator stops flashing and remains lit.

11 Press $\odot/|$ to turn off the unit (on standby) if you have set the timer with the unit turned on.

The STANDBY/ON lamp lights red.



If the unit is kept turned on when the timer-on time comes

Daily Timer does not work at all.



If you change the source or press CLOCK/TIMER while Daily Timer is operating

Daily Timer is canceled and the unit does not turn off automatically.

To turn on or off Daily Timer after its setting is done

- 1 Press **CLOCK/TIMER** repeatedly until “**DAILY TIMER**” appears in the main display.



- 2 To turn off the Daily Timer, push the joy control downward (◀◀ ∨) to select “**OFF**,” then press **SET**. The **DAILY** indicator goes off from the display. The Daily Timer is canceled, but the setting for the Daily Timer remains in memory.

To turn on the Daily Timer, press SET (after making sure that “ON” is selected in the main display). The **DAILY** indicator lights on the display. The settings you have done are shown in the main display for your confirmation.

Using Sleep Timer

With Sleep Timer, you can fall asleep to your favorite music.

You can set Sleep Timer when the unit is turned on.

How Sleep Timer actually works

The unit automatically turns off after the specified time length passes.

On the remote control ONLY:

- 1 Press **SLEEP**.
 - Each time you press the button, the time length changes as follows:

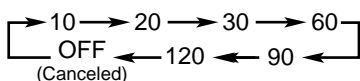

- 2 Wait for about 4 seconds after specifying the time length. The display window dims.

To check the remaining time until the shut-off time, press **SLEEP** once. The remaining time until the shut-off time appears for about 4 seconds.

To change the shut-off time, press **SLEEP** repeatedly until the time length you want appears.

To cancel the setting, press **SLEEP** repeatedly until “**SLEEP OFF**” appears in the main display.

- Turning off the unit or pressing **CLOCK/TIMER** also cancels Sleep Timer.

To sleep with the Sleep Timer and wake up with the Daily Timer

The unit turns off when the shut-off time comes (set by the Sleep Timer), and turns on when the timer-on time (set by the Daily Timer) comes.

- 1 Set the Daily Timer as explained on pages 52 and 53.
- 2 Start playing back any source you want to listen to before sleep.
- 3 Set the Sleep Timer.

Timer Priority

Since each timer can be set separately, you may wonder what happens if the setting for these timers overlaps. Here are the priorities for each timer.

- **A timer with the late timer-on time has priority.** If Recording Timer is set to come on while Daily Timer is operating, Daily Timer is canceled.

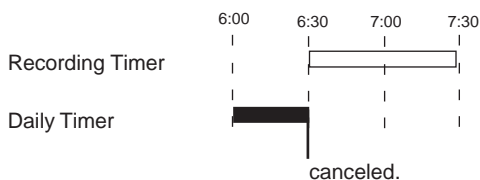

- If Recording Timer is set to come on while Sleep Timer is operating, Sleep Timer will not shut off the power even if the shut-off time comes.

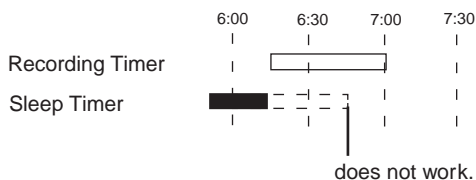

Maintenance

To get the best performance of the unit, keep your discs and mechanism clean.

General Notes

In general, you will have the best performance by keeping your CDs, MDs and the mechanism clean.

- Store CDs and MDs in their cases, and keep them in cabinets or on shelves.
- Keep the CD trays, and the MD loading slot cover closed when not in use.

Handling CDs



- Remove the CD from its case by holding it at the edge while pressing the center hole lightly.
- Do not touch the shiny surface of the disc, or bend the CD.
- Put the CD back in its case after use to prevent warping.

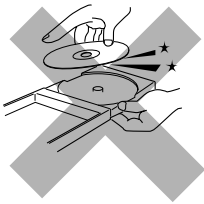

- Be careful not to scratch the surface of the CD when placing it back in its case.
- Avoid exposure to direct sunlight, temperature extremes, and moisture.

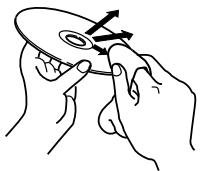

To clean the CD

Wipe the CD with a soft cloth in a straight line from center to edge.

Handling MDs

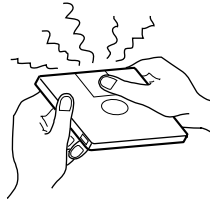

- Do not open the shutter.
 - The shutter is locked so that it will not open. Trying to force it open will break the MD. If the shutter opens accidentally, close it again quickly without touching the MD inside.

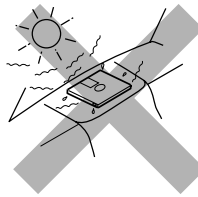

- Do not place MDs in the following places:
 - High temperature areas such as in direct sunlight or inside a car.
 - High humidity areas, e.g. in a bathroom.
 - On a beach or sandy area.

- Clean MDs regularly.
 - If dust or dirt gets on cartridge, wipe it off with a soft dry cloth.



DO NOT use any solvent — such as conventional record cleaner, spray, thinner, or benzine — to clean the CD.

MD Disc Types

There are two types of MDs: Premastered (prerecorded) and Recordable (blank).

Premastered MDs

Premastered MDs, which have been recorded at music studio, can be played back like regular CDs. On an MD of this type, data is recorded as the presence or absence of tiny pits. A laser beam focuses on the pits on the surface of the MD and reflects the detection back to the lens in the MD recorder. The MD recorder then decodes the signals and plays them back as music. This type of MD is called an “optical disc.”

Recordable MDs

Recordable MDs, which use magneto-optical technology, can be recorded and played back repeatedly. The laser inside the MD recorder applies heat to the MD, demagnetizing the magnetic layer of the MD for recording and playback. This type of MD is called an “magnetic-optical disc.”

ATRAC (Adaptive TRansform Acoustic Coding)

The MD provides 80 minute recording and playback time, the same as an audio CD, but in a diameter of only 64 mm. This ability to store such a large amount of data is the result of ATRAC, an audio compression technique developed for MD. This technology cuts out faint sounds that would not be heard by the human beings. This technology, based on human sensitivity to sounds, reduces recorded data volume up to about one-fifth of that of the original data.

UTOC (User Table Of Contents)

Found only on recordable MDs, this area contains sub-data (track number, recording data, etc.) which can be rewritten by the user.

UTOC enables us to search tracks quickly and edit tracks on the MD.

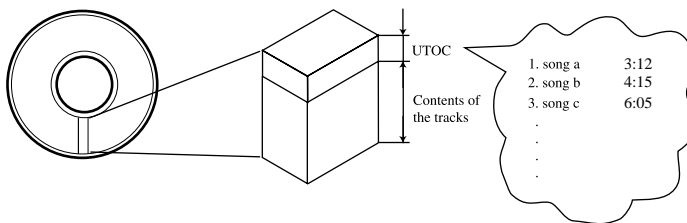

SCMS (Serial Copy Management System)

The MD recorder integrated to this unit uses the Serial Copy Management System which allows only first-generation digital copies to be made of premastered software (like CDs or prerecorded MDs).

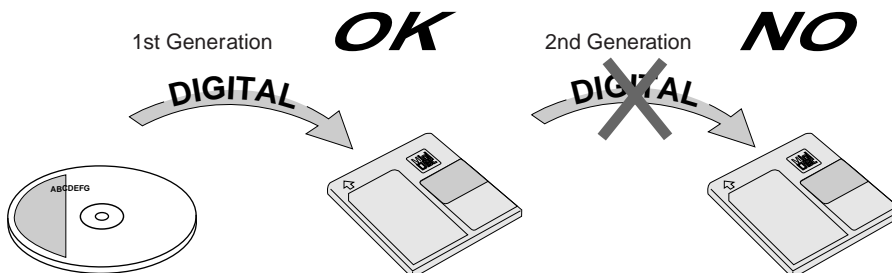

Sound Skip Guard Memory

The biggest weakness of discs is their susceptibility to vibration. The “Sound Skip Guard Memory” has been developed to cope with this weakness.

With this function, a few seconds of signals read by the optical read head from the MD are first stored in memory before being reproduced as audio signals. Thus, even when vibration or shock interrupts signals being read, these stored signals can continue to reproduce sounds for the few seconds. Thus, the user will enjoy uninterrupted music.

Normally....

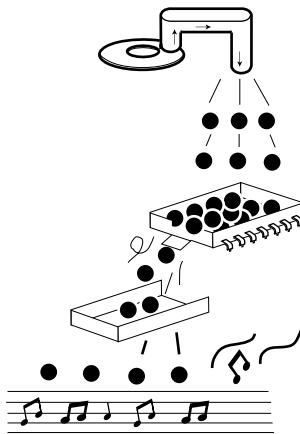

When “vibrated”....

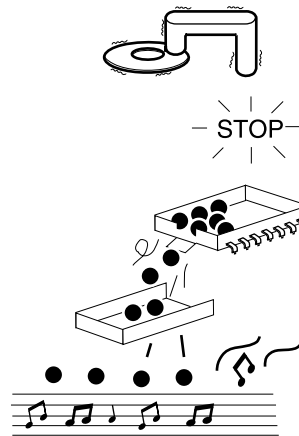

MD limitations	
The MD records data in an original format that differs from that of conventional cassette tapes or DATs. Since there are some limitations with this recording format, the following types of symptoms may occur. These symptoms are not malfunctions.	
Symptoms	Cause
“DISC FULL” appears, even though there is still enough remaining time on an MD.	There is a maximum number of tracks which can be recorded, regardless of recording time. More than 254 tracks cannot be recorded on an MD.
“DISC FULL” appears, even though the number of tracks and recording time do not reach the limit.	<ul style="list-style-type: none"> Repeating erasure and recording on the same MD creates many blank portions sparsely on the MD. When recording on such an MD, a track is recorded on these blank portions sparsely. If a track is divided and recorded into so many portions, “DISC FULL” appears. If a divided portion of less than 8 seconds is made while a track is recorded on the MD, that track cannot be joined to another track using the JOIN function. Furthermore, if that track is erased, the remaining time of the MD may not increase exactly by the erased amount. If a track has been divided into many portions while being recorded on the MD, sounds will drop out while fast forwarding or reversing such an MD.
The JOIN function sometimes does not work.	
The remaining time on the MD does not increase even when tracks are erased.	
The sound drops out during fast forward or fast reverse.	
The amount of recorded time on the MD added to the amount of remaining time is shorter than the MD’s total possible recording time.	You cannot record on a blank portion of less than 2 seconds in the MD. For this reason, the actual recording time of discs may become shorter.

MD Messages

Message	Signification	Solution
BLANK DISC	The disc is blank.	Change the MD with another if you want to enjoy playback.
CANNOT JOIN	You are trying to join tracks which cannot be joined.	This is not a malfunction. (See “MD limitations” on page 57.)
DISC ERROR	There is a problem with this MD.	Change the MD.
DISC FULL	There is no more space on the MD or there are over 254 tracks.	Use another recordable MD or erase some tracks.
EMERGENCY STOP	A malfunction has occurred during recording.	Eject the MD and re-insert it.
MD NO DISC	There is no MD.	Put an MD.
NON-AUDIO CANNOT COPY	You are trying to copy a non-audio disc like a CD-ROM, Video CD, or DVD.	Stop recording.
PLAYBACK DISC	You are trying to edit or record on a playback-only MD.	Use a recordable MD.
DISC PROTECTED	The MD is write-protected.	Unprotect the MD or use another. (See page 33.)
SCMS CANNOT COPY	Digital copy of the 2nd generation is prohibited.	Use an analog recording method.

Troubleshooting

If you are having a problem with your unit, check this list for a possible solution before calling for service.

If you cannot solve the problem from the hints given here, or the unit has been physically damaged, call a qualified person, such as your dealer, for service.

Symptom	Possible Cause	Action
No sound is heard.	Connections are incorrect, or loose.	Check all connections and make corrections. (See pages 6 – 9.)
Unable to record on an MD.	<ul style="list-style-type: none"> You are using a prerecorded MD. The MD is write-protected. 	<ul style="list-style-type: none"> Change it with a recordable MD. Unprotect the MD. (See page 33.)
Poor radio reception.	<ul style="list-style-type: none"> The antenna is not connected correctly. The AM loop antenna is too close to the unit. The FM antenna is not properly extended and positioned. 	<ul style="list-style-type: none"> Reconnect the antenna securely. Change the position and direction of the AM loop antenna. Extend FM antenna to the best reception position.
Unable to operate the remote control.	<ul style="list-style-type: none"> The path between the remote control and the remote sensor on the unit is blocked. The batteries have lost their charge. 	<ul style="list-style-type: none"> Remove the obstruction. Replace the batteries. (See page 9.)
Loaded CDs and MD cannot be ejected.	<ul style="list-style-type: none"> The main AC power cord is not plugged in. The Disc Lock function is in use. 	<ul style="list-style-type: none"> Plug in the AC power plug. Turn off the Disc Lock function. (See page 31.)
The CD does not play.	The CD is upside down.	Put the CD in with the label side up.
The CD skips.	The CD is dirty or scratched.	Clean or replace the CD. (See page 55.)
If “AUX DIGITAL UNLOCK” appears in the main display.	There is no digital device connected to the AUX terminal.	Connect a digital device using digital optical cord. (See page 8.)
If “CAUTION!” appears in the main display.	Something is wrong with your unit.	Unplug the unit immediately, then consult your dealer.
Operations are disabled.	The built-in microprocessor has malfunctioned due to external electrical interference.	Unplug the unit then plug it back in.



When you turn on the unit in the POWER SAVING mode

A mechanical noise will be heard from the MD recorder section. This is a startup noise of power supply to the MD mechanism, not a malfunction of the unit.

Specifications

Amplifier

Output Power (IEC 268-3/DIN):

30 watts per channel, min. RMS, both channels driven into 6 ohms at 1 kHz, with no more than 0.9% total harmonic distortion

Audio input sensitivity/Impedance (at 1 kHz)

Analog input:

TAPE: 500 mV/47 kohms (at "INPUT Level 1")
195 mV/47 kohms (at "INPUT Level 2")

Digital input:

AUX: Optical
Signal wave length: 660 nm
Input level: -23 dBm to -15 dBm
(With the built-in sampling rate converter, corresponding to 32 kHz/44.1 kHz/48 kHz)

Audio output level/Impedance (at 1 kHz)

TAPE: 160 mV/3.9 kohms

Speakers/Impedance: 6 – 16 ohms

Tuner

FM tuning range: 87.50 — 108.00 MHz

AM (MW/LW) tuning range:

MW: 522 — 1,629 kHz
LW: 144 — 288 kHz

CD player

CD Capacity: 3 CDs

Dynamic range: 92 dB

Signal-to-noise ratio: 100 dB

Wow and flutter: Immeasurable

MD recorder

Audio playing system: MiniDisc digital audio system

Recording system: Magneto-optical overwrite system

Reading system: Non-contact, semiconductor laser pickup ($\lambda=780$ nm)

Error correction system: CIRC (Cross Interleave Reed-Solomon Code)

Sampling frequency: 44.1 kHz
(With sampling rate converter for recording — 32 kHz/44.1 kHz/48 kHz)

Audio compression system:

ATRAC (Adaptive TRansform Acoustic Coding)

General

Power requirement: AC 230V~, 50 Hz

Power consumption: 95 watts (at operation)

1.6 watts (on standby: with Power Saving On)

14 watts (on standby: with Power Saving Off)

Dimensions (approx.): 215 x 180 x 346 mm (W/H/D)
(8¹/₂ x 7¹/₈ x 13⁵/₈ in.)

Mass (approx.): 6.9 kg (15.3 lbs)

Supplied accessories

See page 6.

Design and specifications are subject to change without notice.

US and foreign patents licensed from Dolby Laboratories Licensing Corporation.
--



JVC
VICTOR COMPANY OF JAPAN, LIMITED