

KENWOOD

MD RECORDER

DM-VH7

INSTRUCTION MANUAL

KENWOOD CORPORATION

Before installation, read the section entitled "Installation" for correct installation.



B60-4261-00

EN

2 Before applying power

 **Caution : Read this page carefully to ensure safe operation.**

DM-VH7 (EN)

Units are designed for operation as follows.

U.S.A. AC 120 V only

Europe & U.K. AC 230 V only





The marking of products using lasers (Except for some areas)

**CLASS 1
LASER PRODUCT**

The marking is located on the rear panel and says that the component uses laser beams that have been classified as Class 1. It means that the unit is utilizing laser beams that are of a weaker class. There is no danger of hazardous radiation outside the unit.



Safety precautions

WARNING : TO PREVENT FIRE OR ELECTRIC SHOCK, DO NOT EXPOSE THIS APPLIANCE TO RAIN OR MOISTURE.

	CAUTION RISK OF ELECTRIC SHOCK DO NOT OPEN		CAUTION: TO REDUCE THE RISK OF ELECTRIC SHOCK, DO NOT REMOVE COVER (OR BACK). NO USER-SERVICEABLE PARTS INSIDE. REFER SERVICING TO QUALIFIED SERVICE PERSONNEL.
	THE LIGHTNING FLASH WITH ARROWHEAD SYMBOL, WITHIN AN EQUILATERAL TRIANGLE, IS INTENDED TO ALERT THE USER TO THE PRESENCE OF UNINSULATED "DANGEROUS VOLTAGE" WITHIN THE PRODUCT'S ENCLOSURE THAT MAY BE OF SUFFICIENT MAGNITUDE TO CONSTITUTE A RISK OF ELECTRIC SHOCK TO PERSONS.		
	THE EXCLAMATION POINT WITHIN AN EQUILATERAL TRIANGLE IS INTENDED TO ALERT THE USER TO THE PRESENCE OF IMPORTANT OPERATING AND MAINTENANCE (SERVICING) INSTRUCTIONS IN THE LITERATURE ACCOMPANYING THE APPLIANCE.		

Contents

Caution : Read the pages marked  carefully to ensure safe operation.

 Before applying power	2
 Safety precautions	2
 IMPORTANT SAFEGUARDS	4
Before operation	6
Accessories	6
Special feature	7
Safety Precautions	8
Maintenance	9
Installation	10
Changing the installation method	10
How to replace the front feet	11
System connections	12
System operation features	13
Names and functions of parts	14
Display/Main unit	14
Remote control unit	15
Operation of remote control unit	16
Playback of Mini Disc	17
Playing tracks in order from track No. 1	17
Playback from desired track	18
Listening in random order (RANDOM playback)	18
Searching a desired track by its title (TITLE SEARCH)	20
Programming	21
Programming tracks in a desired order	21
Repeated playback	23
Systematized recording features	24
Recording a single CD track (O.T.E.)	24
Recording all tracks on a CD (O.T.E.)	24
Synchro recording with CD player	25
Recording	26
General recording	26
Starting recording from the sound before the current sound (MEMORY REC)	28
REC MODE key	28
Changing the displayed contents	30
TIME DISP. key	30
MONITOR key	30
REC INPUT switching	30
Editing	31
Selecting the editing function type	31
Moving the order of the track being played in a disc (MOVE)	32
Reordering several tracks at a time (QUICK MOVE)	34
Dividing a track during playback (DIVIDE)	36
Combining tracks during playback (COMBINE)	38
Erasing several tracks at a time (QUICK ERASE)	40
Erasing a single track during playback (ERASE)	42
How to edit titles	43
In case of difficulty	47
Specifications	50

4 IMPORTANT SAFEGUARDS

 **Caution :** Read this page carefully to ensure safe operation.

DM-VH7 (EN)

Please read all of the safety and operating instructions before operating this appliance. Adhere to all warnings on the appliance and in the instruction manual. Follow all the safety and operating instructions. These safety and operating instructions should be retained for future reference.

- 1. Power sources** – The appliance should be connected to a power supply only of the type described in the instruction manual or as marked on the appliance. If you are not sure of the type of power supply to your home, consult your appliance dealer or local power company. For appliances intended to operate from battery power, or other sources, refer to the instruction manual.
- 2. Power-cord protection** – Power-supply cords should be routed so that they are not likely to be walked on or pinched by items placed upon or against them, pay particular attention to cords at plugs, convenience receptacles, and the point where they exit from the appliance.

Never pull or stretch the cord.

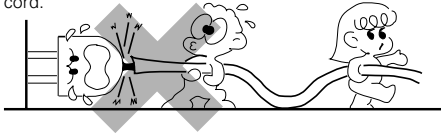

- 3. CAUTION – Polarization** – This appliance may be equipped with a polarized alternating-current line plug (a plug having one blade wider than the other). This plug will fit into the power outlet only one way. This is a safety feature. If you are unable to insert the plug fully into the outlet, try reversing the plug. If the plug should still fail to fit, contact your electrician to replace your obsolete outlet. Do not defeat the safety purpose of the polarized plug.

- 4. Ventilation** – Slots and openings in the cabinet are provided for ventilation and to ensure reliable operation of the appliance and to protect it from overheating, and these openings must not be blocked or covered. The appliance should be situated so that its location or position does not interfere with its proper ventilation.

To maintain good ventilation, do not put records or a tablecloth on the appliance. Place the appliance at least 10 cm away from the walls.

Do not use the appliance on a bed, sofa, rug or similar surface that may block the ventilation openings. This appliance should not be placed in a built-in installation such as a bookcase or rack unless proper ventilation is provided or the manufacturer's instructions have been adhered to.

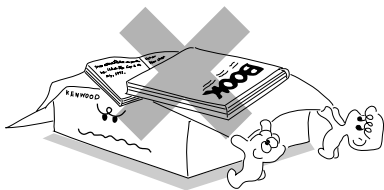

- 5. Water and moisture** – The appliance should not be used near water - for example, near a bathtub, washbowl, kitchen sink, laundry tub, in a wet basement, or near a swimming pool, etc.

- 6. Temperature** – The appliance may not function properly if used at extremely low, or freezing temperatures. The ideal ambient temperature is above +5°C (41°F).
- 7. Heat** – The appliance should be situated away from heat sources such as radiators, heat registers, stoves, or other appliances (including amplifiers) that produce heat.
- 8. Electric shock** – Care should be taken so that objects do not fall and liquid is not spilled into the enclosure through openings. If a metal objects, such as a hair pin or a needle, comes into contact with the inside of this appliance, a dangerous electric shock may result. For families with children, never permit children to put anything, especially metal, inside this appliance.

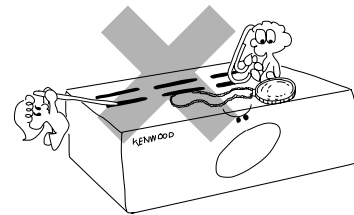

- 9. Enclosure removal** – Never remove the enclosure. If the internal parts are touched accidentally, a serious electric shock might occur.

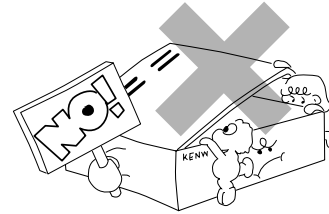

- 10. Magnetic fields** – Keep the appliance away from sources of magnetic fields such as TV sets, speaker systems, radios, motorized toys or magnetized objects.

- 11. Cleaning** – Unplug this appliance from the wall outlet before cleaning. Do not use volatile solvents such as alcohol, paint thinner, gasoline, or benzene, etc. to clean the cabinet. Use a clean dry cloth.

- 12. Accessories** – Do not place this appliance on an unstable cart, stand, tripod, bracket, or table. The appliance may fall, causing serious injury to a child or adult, and serious damage to the appliance. Use only with a cart, stand, tripod, bracket, or table recommended by the manufacturer, or sold with the appliance. Any mounting of the appliance should follow the manufacturer's instructions, and should use a mounting accessory recommended by the manufacturer. An appliance and cart combination should be moved with care. Quick stops, excessive force, and uneven surfaces may cause the appliance and cart combination to overturn.



13. Lightning – For added protection for this appliance during a lightning storm, or when it is left unattended and unused for long periods of time, unplug it from the wall outlet and disconnect the antenna or cable system. This will prevent damage to the appliance due to lightning and power-line surges.

14. Abnormal smell – If an abnormal smell or smoke is detected, immediately turn the power OFF and unplug the appliance from the wall outlet. Contact your dealer or nearest service center.

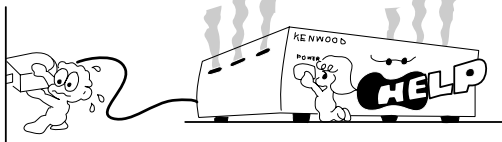

15. Damage requiring service – The appliance should be serviced by qualified service personnel when:

- A.** The power-supply cord or the plug has been damaged.
- B.** Objects have fallen, or liquid has been spilled into the appliance.
- C.** The appliance has been exposed to rain or water.
- D.** The appliance does not appear to operate normally by following the instruction manual. Adjust only those controls that are covered by the instruction manual as an improper adjustment of other controls may result in damage and will often require extensive work by a qualified technician to restore the appliance to its normal operation.
- E.** The appliance has been dropped, or the enclosure damaged.
- F.** The appliance exhibits a marked change in performance.

16. Servicing – The user should not attempt to service the appliance beyond that described in the instruction manual. All other servicing should be referred to qualified service personnel.

17. Outdoor antenna grounding – If an outside antenna is connected to the appliance, be sure the antenna system is grounded so as to provide some protection against voltage surges and built up static charges. Article 810 of the National Electrical Code ANSI/NFPA 70, provides information with respect to proper grounding of the mast and supporting structure, grounding of the lead-in wire to an antenna discharge unit, size of grounding conductors, location of antenna discharge unit, connection to grounding electrodes, and requirements for the grounding electrode. See Figure.

18. Power lines – An outside antenna system should not be located in the vicinity of overhead power lines or other electric light or power circuits, or where it can fall into such power lines or circuits. When installing an outside antenna system, extreme care should be taken to keep from touching such power lines or circuits as contact with them might be fatal.

19. AC outlets – Do not connect other audio equipment with a power consumption larger than that specified to the AC outlet on the rear panel. Never connect other electrical appliances, such as an iron or toaster, to it to prevent fire or electric shock.

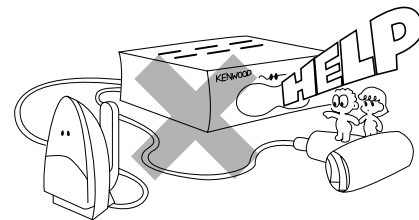

20. Overloading – Do not overload wall outlets, extension cords, or integral convenience receptacles as this can result in a risk of fire or electric shock.

21. Attachment – Do not use attachments not recommended by the appliance manufacturer as they may cause hazards.

22. Replacement parts – When replacement parts are required, be sure the service technician has used replacement parts specified by the manufacturer or have the same characteristics as the original parts. Unauthorized substitutions may result in fire, electric shock, or other hazards.

23. Safety check – Upon completion of any service or repairs to this appliance, ask the service technician to perform safety checks to determine that the appliance is in proper operating condition.

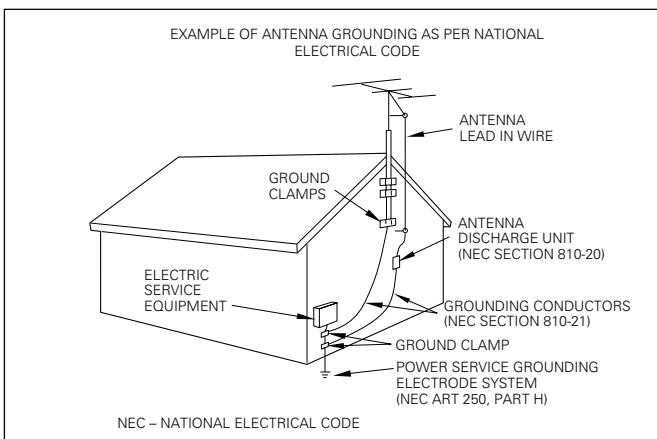

Notes:

1. Item 3 is not required except for grounded or polarized equipment.
2. Item 17 and 18 are not required except for units provided with antenna terminals.
3. Item 17 complies with UL in the U.S.A.

Unpacking

Unpack the unit carefully and make sure that all accessories are put aside so they will not be lost. Examine the unit for any possibility of shipping damage. If your unit is damaged or fails to operate, notify your dealer immediately. If your unit was shipped to you directly, notify the shipping company without delay. Only the consignee (the person or company receiving the unit) can file a claim against the carrier for shipping damage. We recommend that you retain the original carton and packing materials for use should you transport or ship the unit in the future.

Keep this manual handy for future reference.

Accessories

Check that the following accessories are present.

Audio cord (2)

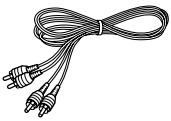

System control cord (1)

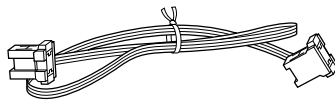

Optical fiber cable (1)

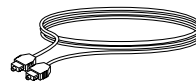

Allen wrench (1)



Remote control unit (1)

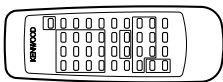

Batteries (R6/AA) (2)

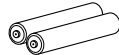

Replacement front feet (2)

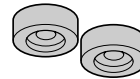

Spacer (1)

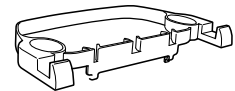

Special feature

This unit is audio equipment based on the Mini Disc format. The Mini Disc (MD) is an application of the optical and magneto-optical technology and has the capability to record signals on discs. The operability of the MD is equivalent to the Compact Disc (CD). The MD uses optional non-contact system so the recordings are not degraded by eternal factors and the discs are never scratched or damaged in playback.

Digital recording volume control

The recording level adjustment which used to be possible only with analog input signals is now available with digital input signals.

Free layout

The unit can be installed vertically on the side as well as the conventional, horizontal installation. Much freer system setting than before is now possible.

Title input & title search

The titles of tracks recorded onto an MD can be assigned and stored in the MD. The title search facility allows you to search desired tracks by their titles.

Various editing features

In addition to usual editing modes (MOVE, DIVIDE, COMBINE and ERASE), this unit incorporates versatile editing features such as QUICK MOVE for reordering the tracks in an MD simultaneously and QUICK ERASE for erasing desired tracks.

Simplified CD recording (O.T.E.)

When the unit is used in combination with the CD receiver (RD-VH7), the desired track in a CD can be recorded onto an MD with a single operation (O.T.E.: One Touch Edit).

Simplified playback with a one-touch operation

Even when the unit is off (STANDBY mode of power), playback can be started easily by simply pressing the play key on the front panel.

Sampling rate converter

The unit incorporates a sampling rate converter to handle different kinds of digital sources (32kHz, 44.1kHz, 48kHz).

Safety Precautions

Installation position

The MD recorder is very sensitive to vibrations. It should be installed in a position subject to as small vibration as possible.

Caution on condensation

Condensation (of dew) may occur inside the unit when there is a great difference in temperature between this unit and the outside.

This unit may not function properly if condensation occurs. In this case, leave the unit for a few hours with the power left ON, and restart the operation after the condensation has dried up.

Be specially cautious against condensation in a following circumstance:

When this unit is carried from a place to another across a large difference in temperature, when the humidity in the room where this unit is installed increases, etc.

Memory backup

The memory storage is held for about a day after the power cord has been unplugged from the power outlet. In case the power supply has stopped or the power cord has been left unplugged for an extended period of time, the information related to recording and editing (recorded at the moment a Mini Disc is ejected) may be cleared or destroyed before it is recorded on the disc. The lost information cannot be recovered later.

To ensure the recording of the recording and editing-related information on the Mini Disc, be sure to eject the Mini Disc after every recording or editing operation.

US and foreign patents licensed from Dolby Laboratories.

Handling of Mini Disc

As the Mini Disc is accommodated inside a cartridge, it can be handled without caring about dust or fingerprint. However, stained or soiled cartridge may cause malfunction. To enjoy beautiful sound for extended period of time, take care on the following points.

Do not touch the disc directly.

Do not touch the disc by opening the shutter with your hand. The cartridge will be damaged if it is forced open.

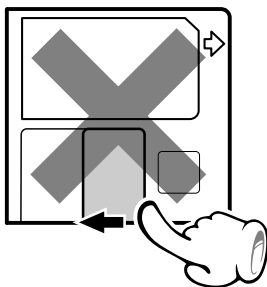

Storage position

Do not leave Mini Discs in place where the temperature and/or humidity are extremely high (for example, in a place subject to direct sunlight).

Dust countermeasure

The shutter of the disc cartridge is permanently open while the disc is loaded in the set. Therefore, to prevent dust from penetrating inside the disc, take the disc out of the unit immediately after completion of recording or playback.

Care

Wipe periodically dust and dirt attached on the cartridge with a dry cloth.

Write protect tab

To protect recorded contents against accidental erasure, set the write protect tab of the disc open. Return the tab to the original position when you want to record signals on the disc.

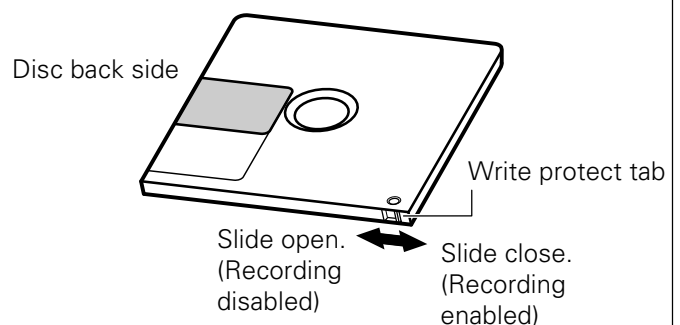

Note related to transportation and movement

Before transporting or moving this unit, carry out the following operations.

1. With no disc loaded in the unit, press the "on/standby" key to on.

- Check that no disc is present in the unit.

2. Wait a few seconds and verify that the display shown appears.**3. Press the "on/standby" key to off (standby).**

Maintenance

Maintenance of the unit

When the front panel or case becomes dirty, wipe with a soft, dry cloth. Do not use thinner, benzine, alcohol, etc. for these agents may cause discoloration.

In regard to contact cleaner

Do not use contact cleaners because it could cause a malfunction. Be specially careful not to use contact cleaners containing oil, for they may deform the plastic component.

The front feet attached at the factory can be replaced with the provided replacement feet. When you want to stack the RD-VH7 (optional) above this unit, installed this unit horizontally by using the provided horizontal installation spacer.

Check the following accessories

Replacement front feet	2
Spacer for horizontal installation	1
Allen wrench	1



- Remove the MD and unplug the power cord before proceeding to the following operation.
- Only the front feet can be replaced.
- When attaching replacement front feet, use only the screws which have been used with the removed feet. (Using other screws may result in a fire or malfunction.)
- If this unit is fell down by mistake after installation and if an MD is left inside the unit, the MD may be damaged.

Changing the installation method

Horizontal, stacked installation (When stacking the optional RD-VH7 above the unit)

Use the provided spacer for horizontal installation.

① Attach the spacer by inserting its claws into the spacer mount holes on the rear of this unit.

NOTE When inserting the claws, align them with the holes by tilting the spacer slightly (about 20 degrees) as shown in the illustration.

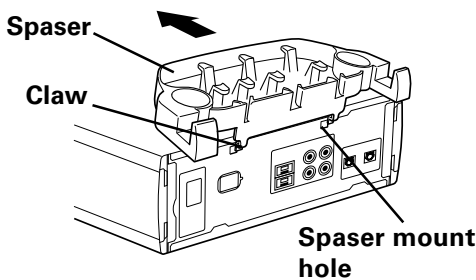

② Arrange the cords by winding them around the spacer.

The audio cords and system control cord can be accommodated into the trench on the spacer by winding them as shown in the illustration.

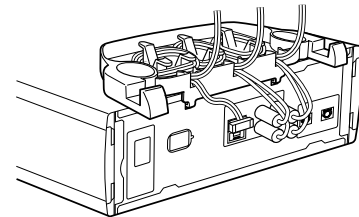

③ Stack the RD-VH7 by aligning its feet with the foot support cavities on the spacer.

Vertical installation

Change the left front foot location as described below.

① Using the Allen wrench, remove the 2 screws from the front foot located on the left when the unit is seen from the front.

② Align the removed front foot with the threaded holes on the rear part of the right side panel, and attach the front foot using the screws removed in step ①.

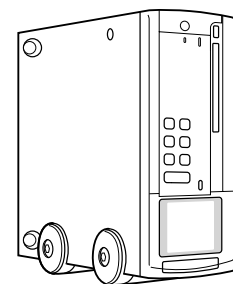
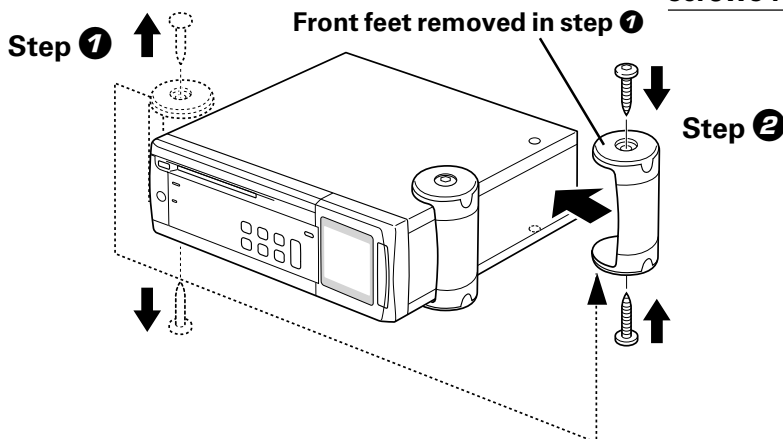

View of the unit when it is placed vertically

How to replace the front feet

The factory-attached front feet can be exchanged with the provided replacement front feet.

- Using the Allen wrench, remove the 2 screws from each front foot.

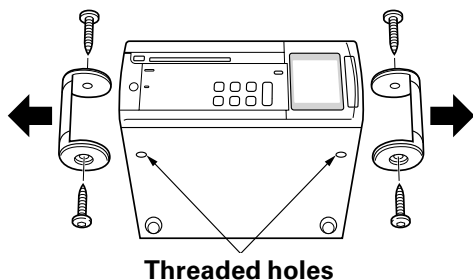

- Attach the provided replacement front feet. Attach using two of the 4 screws removed in step 1.

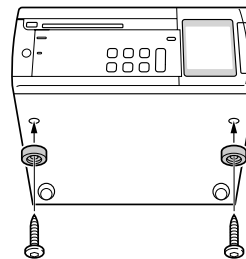

LCD contrast adjustment (Main unit only)

The contrast of the LCD display can be switched as desired.

- Press the mode key.
- Press the ◀◀ or ▶▶ key to select "CONTRAST SET?", then press the enter key.
- Adjust the contrast by pressing the ◀◀ or ▶▶ key, then press the enter key.

- Press and hold the **mode** key for more than 2 seconds to reset the contrast to the initial value.

Adjusting the display orientation (Main unit only)

With the initial setting, the display window of this unit switches the display orientation by automatically (AUTO) detecting the vertical or horizontal installation. However, it is also possible to switch the orientation manually (MANUAL) as desired.

Manual switching procedure

- Press the mode key.
- Press the ◀◀ or ▶▶ key to select "WINDOW SET?", then press the enter key.
- Press the ◀◀ or ▶▶ key to select "MANUAL", then press the enter key.
- Press the ◀◀ or ▶▶ key to select the desired orientation, then press the enter key.

Make connection as shown below. When connecting the related system components, refer also to the instruction manuals of the related components.

Caution: Do not plug in the power lead until all connections are completed.

When installing this unit, reserve a clearance of at least 10cm from the rear wall.

Malfunction of microprocessor



If operation is not possible or erroneous display appears even though all connections have been made properly, reset the microprocessor referring to "In case of difficulty".

→ 47

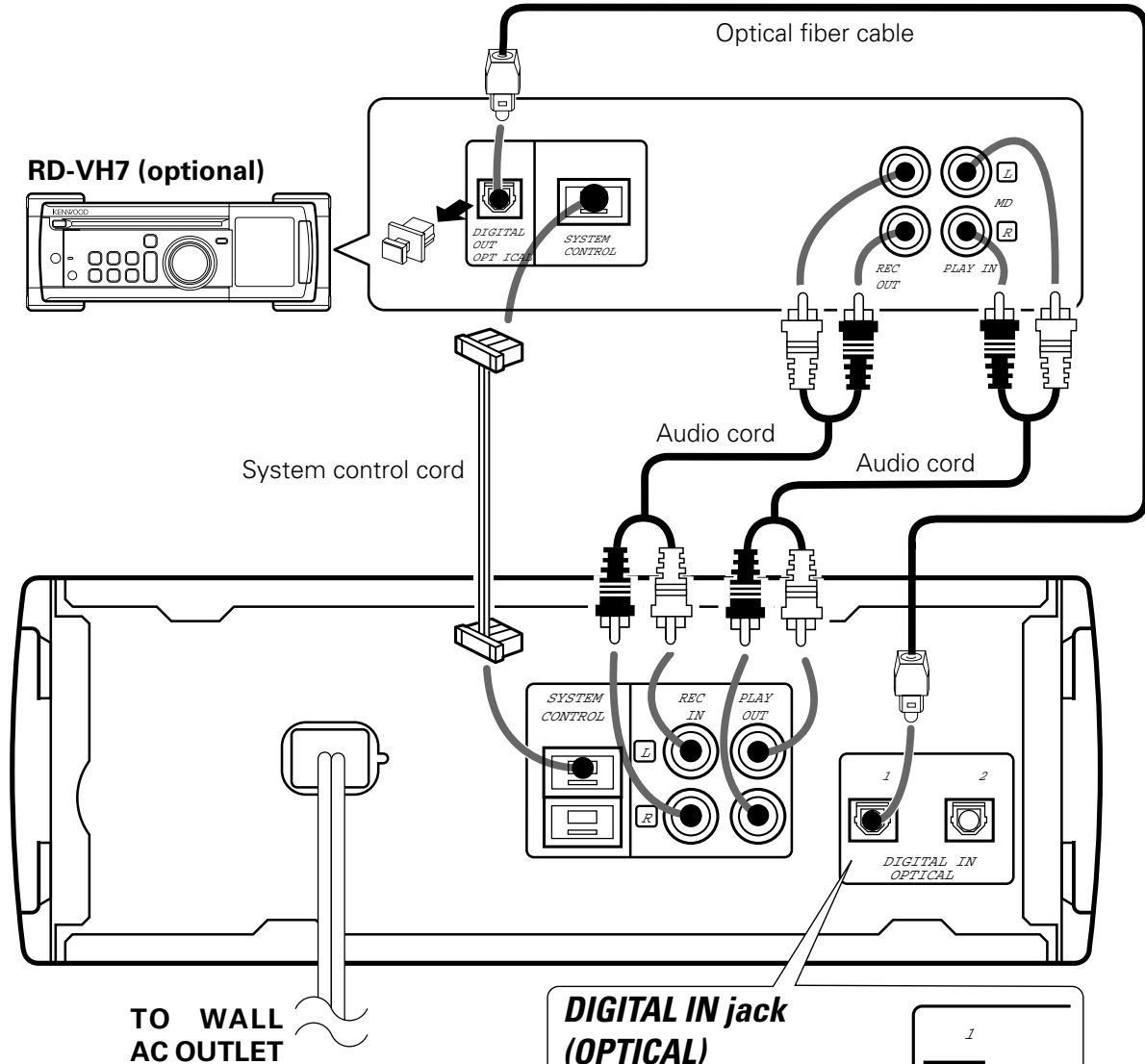

DIGITAL IN jack (OPTICAL)

Remove the protective cap before using the DIGITAL IN jack.

Remove cap.

- To enable system operations including CD recording, it is recommended to connect the CD receiver (RD-VH7) to "DIGITAL IN OPTICAL 1". → 24 → 25
- Commercial digital equipment (BS tuner, DAT, etc.) can be connected to "OPTICAL 2". → 26 → 30

- Be careful not to lose the protective caps.



1. Connect all cords firmly. If connections are loose, there could be loss of sound or noise produced.
2. When plugging and unplugging connection cords, be sure to first remove the power cord from the AC outlet. Plugging/unplugging connection cords without removal of the power cord can cause malfunctions or damage to the unit.

Note on connection of optical-fiber cable

The optical-fiber cable is used in the connection of the CD receiver (optional RD-VH7). The digital signal transmission makes it possible to record the high-quality sound of CDs without degradation.

- Insert the optical-fiber cable straight into the connector until it clicks.
- Be sure to attach the protection cap when the connector is not used.
- Never bend or bundle the optical-fiber cable.

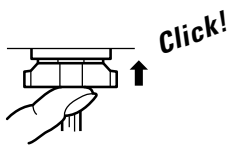
Connection of system control cord**Plugging the connector.**

Insert the connector straight until it clicks.

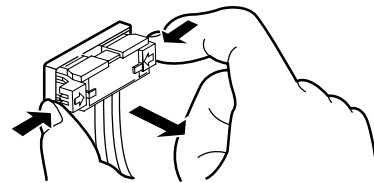
Unplugging the connector

While pushing the two sides of the connector, pull it straight out.

System operation features**Easy operation function**

When this unit is connected with the CD receiver (RD-VH7) through a system control cord, the basic operations of this unit can be controlled from the remote control unit provided with the RD-VH7. This connection also makes possible the easy operation function which activates operations according to the input selection made on the RD-VH7 (two-way operations). For details, refer to the Instruction Manual of the RD-VH7.

Timer recording/playback

When this unit is connected with the CD receiver (RD-VH7) through a system control cord, timer playback of an MD and timer recording of radio broadcasting are possible.

For details, read this instruction manual as well as the Instruction Manual of the RD-VH7.

Operations on this unit: Steps **1** to **3** in "General recording."

Display/Main unit

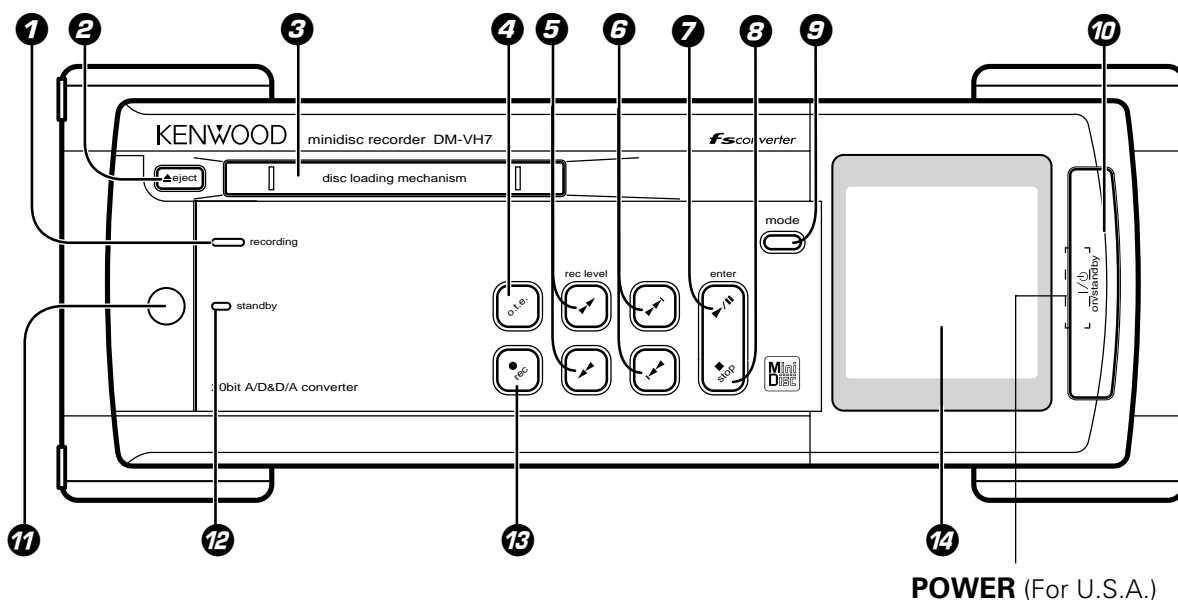

POWER (For U.S.A.)

- 1 recording indicator**
- 2 Eject (▲ eject) key/disc indicator** → 19
Press to unload the Mini Disc.
The indicator lights when a MD is present in the unit.
- 3 Mini Disc insertion slot** → 17
- 4 One-Touch Edit (o.t.e.) key** → 24
Press for one-touch recording of a CD.
- 5 Fast forward and fast backward (◀◀, ▶▶) / rec level keys** → 19
During playback, this key is used to move the played position forward or backward.
During recording, this key is used to adjust the recording level. → 25 → 26
- 6 Skip (◀◀, ▶▶) keys** → 19
Press to skip disc tracks during playback.
In record-pause mode, these keys are used for MEMORY REC operation. → 28
- 7 Play, Pause (▶/||)/enter key** → 17 → 19
Press to start playback.
Press to temporary stop the disc operation.
This key is also used as the enter key of an item set using the mode key. → 11
- 8 Stop (■) key** → 19
Press to stop the disc operation.
- 9 mode key** → 11
Press to adjust the LCD contrast or to switch the display orientation between vertical and horizontal.
- 10 "on/standby (I / ⏻)" key** → 17
Press to turn the unit on or off (standby).
- 11 Remote control sensor** → 16
- 12 standby indicator**
- 13 Record (●) key** → 25 → 26
Press when starting recording.
- 14 Display**

Standby mode

While the standby indicator of the unit is lit, a small amount of current is flowing into the unit's internal circuitry to back up the memory. This condition is referred to as the standby mode of the unit. While the unit is in the standby mode, it can be turned ON from the remote control unit.

Remote control unit

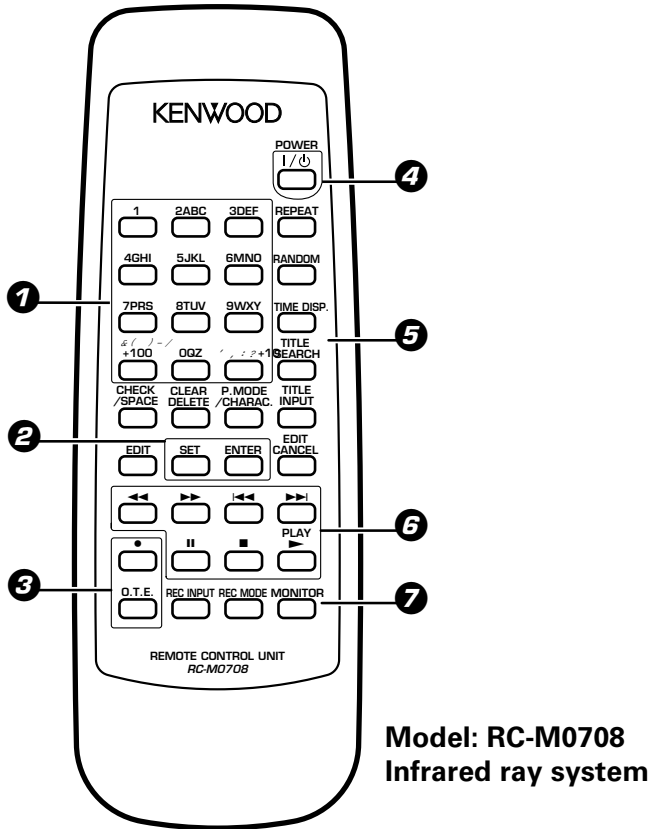

1 Numeric keys

- : Press to specify the desired track number. → 18
- : Used at the time of title input for selection of characters and symbols. → 45

2 Editing mode keys

- SET key** → 32
: Press to set the editing result or input title definitely in memory.
- ENTER key** → 33
: Press to execute editing or title input operation.

3 Recording operation keys

- : Record key
- One-Touch Edit (O.T.E.) key** → 24
: Press for one-touch recording of a CD.

4 on/standby (POWER (I / ⏻)) key

- : Press to turn the unit on or off (standby).

5 Display/program operation keys

- REPEAT key** → 23
: Press to play tracks repeatedly.
- RANDOM key** → 18
: Used at the time of random playback.
- TIME DISP. key** → 30
: Press to switch the time display mode.
- TITLE SEARCH key** → 20
: This key is used to switch the title input mode.
- CHECK/SPACE key** → 22
: This key is used to check the program contents. During title input, it is used to insert a blank space character.
- CLEAR/DELETE key** → 22
: This key is used to clear the program. During title input, it is used to delete a character.
- P.MODE/CHARAC. key** → 21
: This key is used in program playback. During title input, it is used to select the character group.
- TITLE INPUT key** → 43
: This key is used to switch the title input mode.
- EDIT key** → 32
: This key is used to switch the editing mode.
- EDIT CANCEL key** → 33
: Used to cancel editing.

6 Basic operation keys

- ◀▶ : Fast forward and fast backward keys. → 19
At the time of editing, the cursor movement and the selected title can be confirmed. → 34 → 40 → 44
- ◀▶▶ : Skip keys. → 19
During editing, this key is used to select track numbers, title and characters. → 34 → 40 → 43
- ⏸ : Pause key ■ : Stop key
- ▶ : Play key

7 Applied operation keys

- REC INPUT key** → 25 → 26
: This key is used to switch the recording input source.
- REC MODE key** → 28
: Press to switch the recording setting adjustment modes ON/OFF.
- MONITOR key** → 25 → 26 → 30
: Monitors the audio from an input source.

Loading batteries

1 Remove the cover.

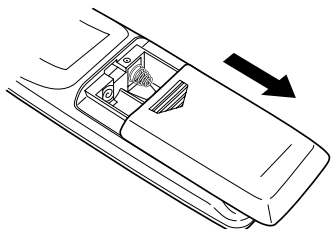

2 Insert batteries.

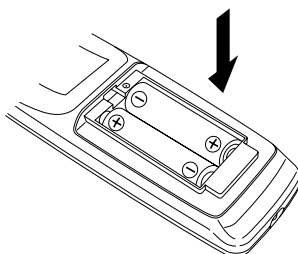

3 Close the cover.

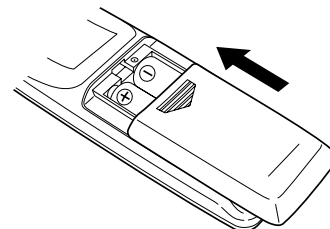

- Insert two R6 ("AA"-size) batteries following the polarity indications.

Operation

The unit can be turned on by plugging the power cord into a power outlet and pressing the "on/standby (POWER (I / ⏻))" key of the remote control unit. After the unit has been turned on, press the desired operation key.

- When pressing more than one remote control keys successively, press the keys securely by leaving an interval of 1 second or more between pressing of keys.

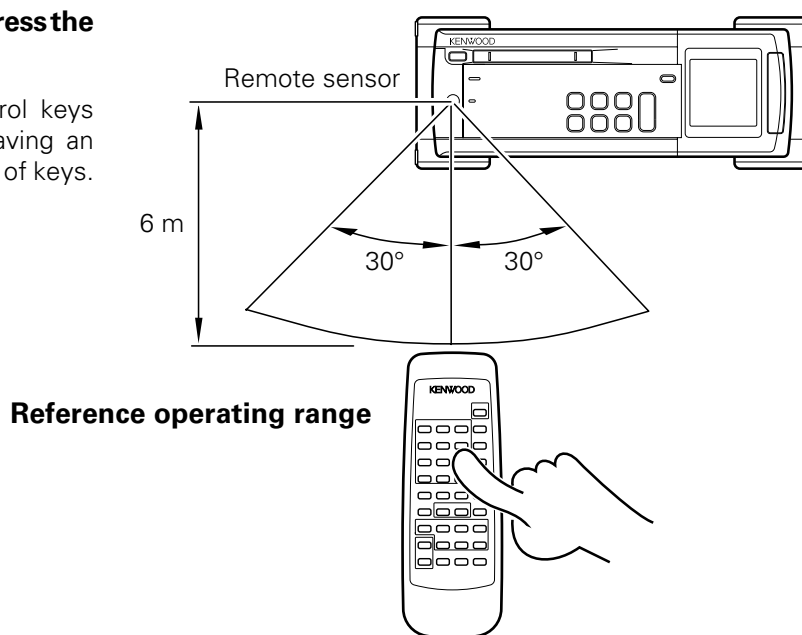

1. The provided batteries are intended for use in operation checking, and their service life may be short.
2. When the remote controllable distance becomes short, replace all batteries with new ones.
3. If direct sunlight or the light of a high-frequency fluorescent lamp (inverter type, etc.) is incident to the remote sensor, malfunction may occur. In such a case, change the installation position to avoid malfunction.

Use the following procedure to play a MD in the original order of tracks from track No. 1.

Playing tracks in order from track No. 1

1 Turn the unit ON.

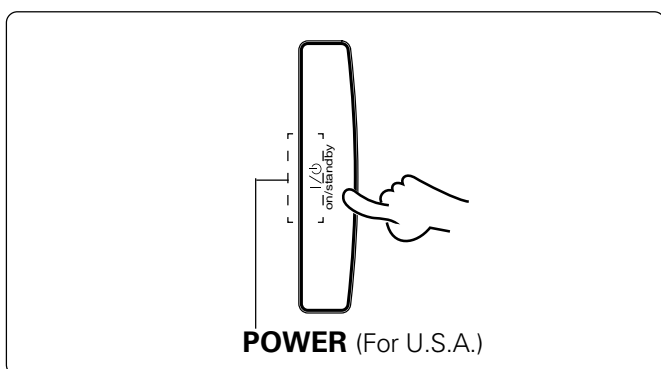

In case no disc is loaded:

2 Load a Mini Disc.

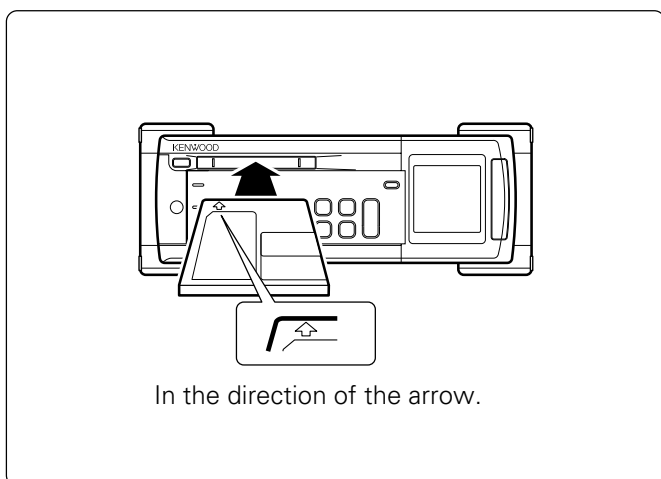

- Insert the minidisc correctly into the slot of this unit.
- The disc indicator lights up when an MD is inserted.
- **"READING"** is displayed while the contents of the MD are checked.
- If a title has been assigned to the disc, that title will be displayed.



3 Start playback.

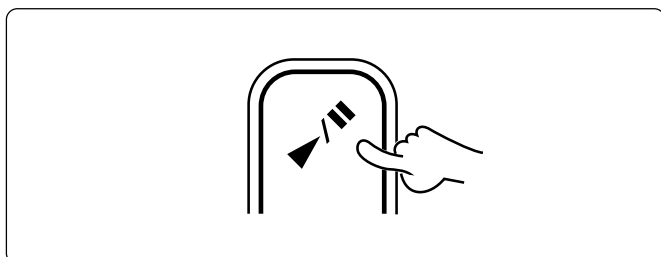

Track No. being played

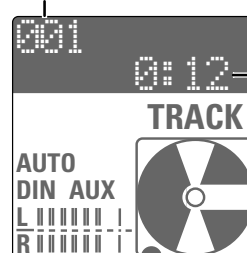

Elapsed time of track being played

Playback from desired track

1 Enter the "TRACK" mode.

Operate in stopped condition.

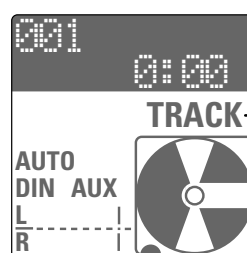

"TRACK" indicator

2 Select the desired track number.

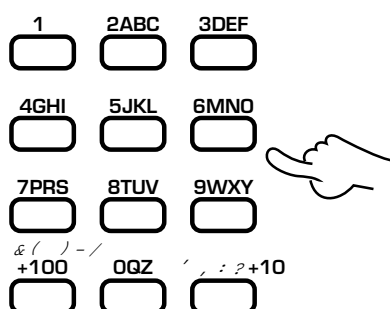

Press the numeric keys as shown below...

To enter track No. 23 : **+10**, **+10**, **3**

To enter track No. 40 : **+10**, **+10**, **+10**, **+10**, **0**

Listening in random order (RANDOM playback)

As the title each time will be selected at random, you can listen for a long time without getting bored.



- Press the **RANDOM** key again to cancel random playback.

To select a different title during listening :

Press the **▶▶** key.

Disc recorded in monaural mode

This unit is capable of playing a disc recorded in the monaural mode.

As the amount of data required to record information in the monaural mode is half the amount required in the stereo mode, the play (record) time of a disc recorded in the monaural mode is twice as that of a disc recorded in the stereo mode.

Skipping tracks

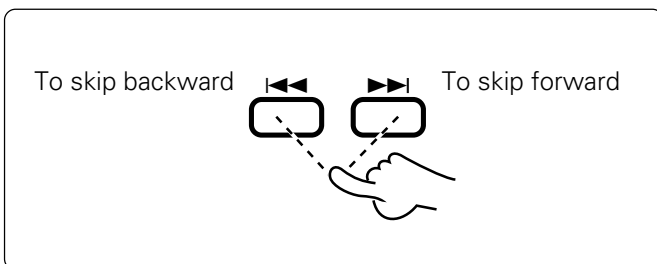

- The track in the direction of the pressed button is skipped, and the selected track will be played from the beginning.
- When the I◀◀ key is pressed once during playback, the track being played will be played from the beginning.
- To skip further to the previous track, press the I◀◀ key quickly.

Searching in a track

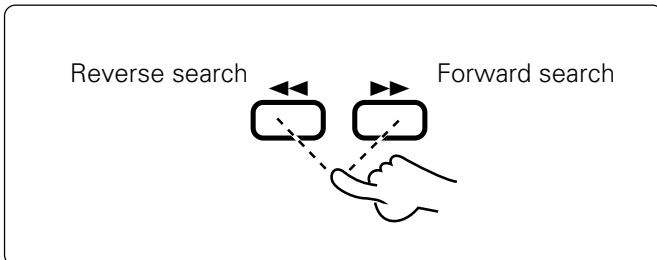

- Playback restarts from the position with which the key is released.
- If forward or reverse search is started during play-pause, the disc can be searched at a high speed but sound is not output.
- When the reverse search is started during the program or random mode and the beginning of the current track is attained, the track will be played from the beginning.

→ 18 → 21

To pause playback

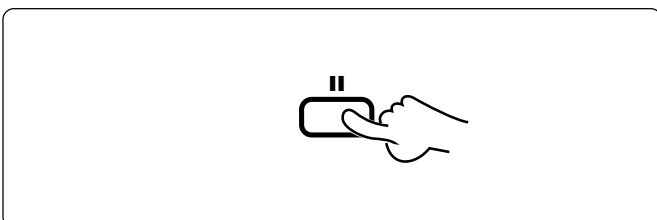

- Each press pauses and plays the MD alternately.

To stop playback

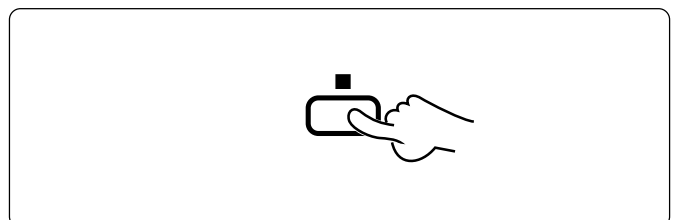

Ejecting the disc

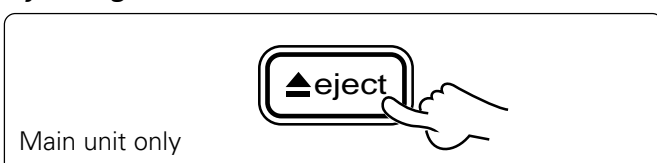

Mini Disc has been ejected.

Preparation ● Enter the "TRACK" mode.



Searching a desired track by its title (TITLE SEARCH)

1 Press the TITLE SEARCH key.



To abort operation, press the **TITLE SEARCH** key again.

2 Select the desired title.

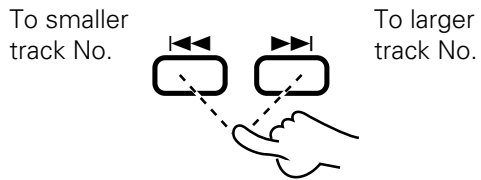

3 Start playback.

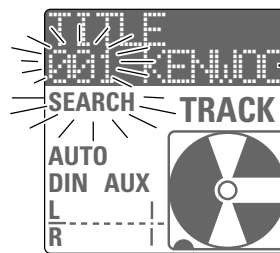

Characters flow toward the left.

- With a track to which no title has been assigned, the track number and "•••••" are displayed.

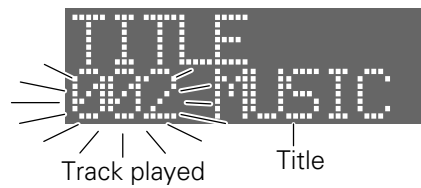

- The track can also be selected using the numeric keys.



Characters flow toward the left.

Use the following procedure to program desired tracks in a desired order. (up to 32 tracks)

Preparation

- Enter stop mode.

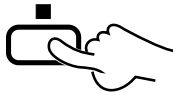

Programming tracks in a desired order

1 Enter the "PGM" mode.

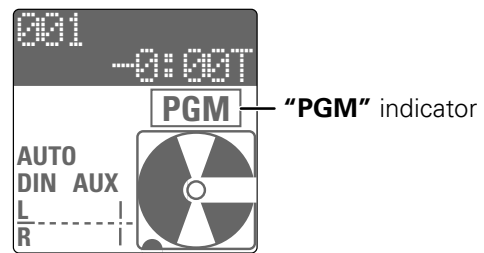

2 Select track numbers in the order you want to play them.

1 Select the track number to be played.

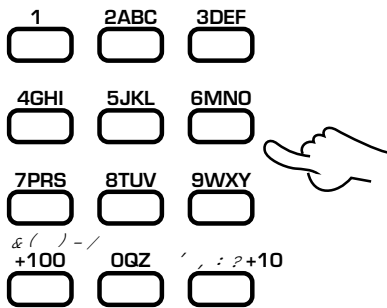

2 Set the input track number.



3 Repeat steps 1 and 2 above.

Press numeric keys in the following order.

To select track No. 12: Press in order of **[+10]**, **[2]** key.

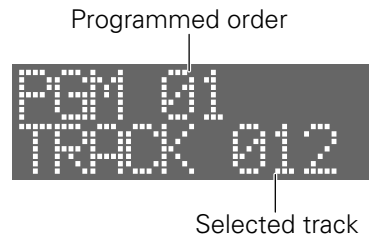

- Up to 32 tracks can be programmed. More than 32 tracks cannot be selected.
- If you made a mistake, press the **CLEAR/DELETE** key and enter the track No. again.
- "--:--" is displayed when the total programmed period has attained 256 minutes or more.

- The input operation is aborted if the **P.MODE/CHARAC.** key is not pressed while the track number indicator is blinking.

3 Start playback.

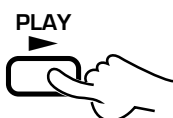

- When the **◀◀** or **▶▶** key is pressed during playback, tracks will be skipped in the direction of the pressed key.

To add a track to the program

Operate in stopped condition.

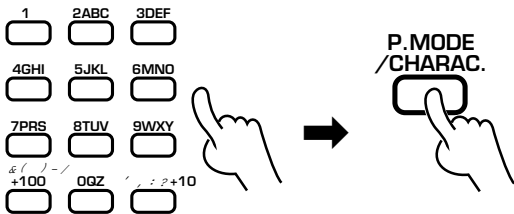

- When a track No. is selected, the track will be added to the end of the existing program.
- The input operation is aborted if the **P.MODE/CHARAC.** key is not pressed while the indicator is blinking.

Checking the order of tracks

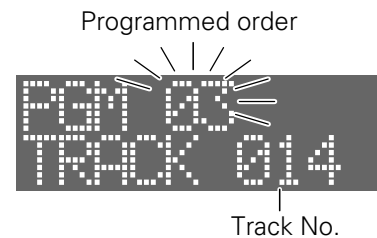

- Each press displays the next track in the program.

To clear tracks from the program (Operate in stopped condition.)

Clearing tracks from the end



The number of the track that has been cleared is displayed.



(Example when P-14 has been cleared)

Clearing all tracks

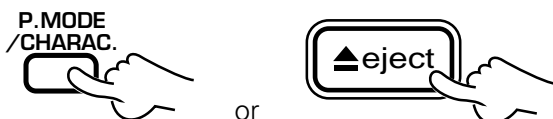

Remote control unit

Main unit

Preparation ● Enter stop mode.

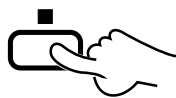

Repeated playback

To repeat the one track or entire disc

❶ Enter the "TRACK" mode.



❷ Let the "ONE REP." or "ALL REP." indicator light.



❸ Start playback.

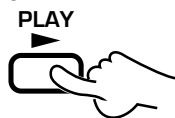

Each press of the REPEAT key switches the mode as follows.

- ▶ **ONE REP.** : Plays a single track repeatedly.
- ▶ **ALL REP.** : Plays all tracks in the MD repeatedly.
- OFF**

- To repeat tracks with RANDOM playback, press the **RANDOM** key after step ❸. "REP." will be displayed whether the selected repeat mode is "ONE REP." or "ALL REP."

To stop repeated playback

Press the REPEAT key to select "OFF".

To repeat only the programmed tracks

❶ Program the tracks to be repeated.

❶ Enter the "PGM" mode.



❷ Select the desired track.

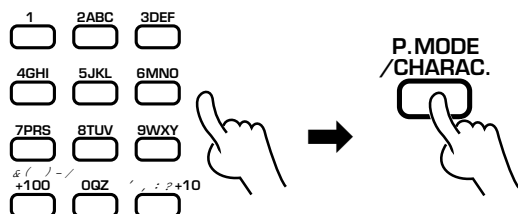

❷ Repeat step ❷ above.

❸ Let the "REP." indicator light.



❹ Start playback.

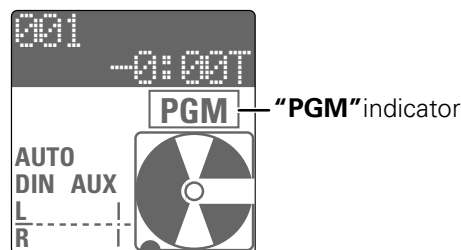

- All of the programmed tracks will be repeated.
- In case only one track is programmed, only that track will be repeated.

Each press of the REPEAT key switches the mode as follows.

- ▶ **REP.** : Plays all the selected tracks repeatedly.
- OFF**

To stop repeated playback

Press the REPEAT key to select "OFF".

When this unit is connected with the CD receiver (RD-VH7) through a system control cord, desired tracks can be selected while playing a CD and recorded automatically onto an MD. This function is referred to as O.T.E. (One Touch Edit). The synchronized recording with CD also possible in this configuration.

Preparation

- Connect the digital output of the CD receiver to DIGITAL 1 input of the MD recorder. → 12
- Select the CD input on the CD receiver.
- Load a recordable MD in the MD recorder. → 8

Display when an MD is loaded

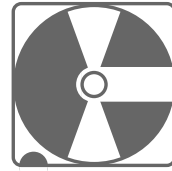

Recordable MD

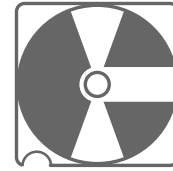

Recording-protected MD

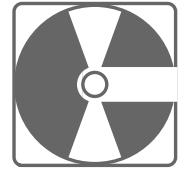

Playback-only MD

Recording a single CD track (O.T.E.)

1 Play the track to be recorded.

2 Press the O.T.E. key.



- When the **O.T.E.** key is pressed during CD playback, the track being played will be replayed from the beginning and only this track will be recorded.
- After the track has been recorded, the MD recorder stops and the CD player enters pause mode.
- With O.T.E. recording, the recording input is automatically set to DIN CD (digital) and the recording level is automatically set to 0 dB.
- It is not possible to change the recording input or recording level during O.T.E. recording.

Press the stop (■) key to stop recording in the middle.

Recording all tracks on a CD (O.T.E.)

1 Stop CD playback.

2 Press the O.T.E. key.



- When the **O.T.E.** key is pressed while the CD player is in stop mode, all of the tracks of the CD will be recorded.
- After the track has been recorded, the MD recorder stops and the CD player enters pause mode.
- With O.T.E. recording, the recording input is automatically set to DIN CD (digital) and the recording level is automatically set to 0 dB.
- It is not possible to change the recording input or recording level during O.T.E. recording.

Press the stop (■) key to stop recording in the middle.

When this unit is connected with the CD receiver (RD-VH7) through a system control cord, recording (MD) and playback (CD) can be started simultaneously so that playback sound can be recorded without the loss of any part.

Preparation

- Connect the digital output of the CD receiver to DIGITAL 1 input of the MD recorder. → 12
- Select the CD input on the CD receiver.
- Load a recordable MD in the MD recorder. → 8

Synchro recording with CD player

1 Select the REC INPUT.



Each press switches the mode. → 30

ANALOG
DIN CD
MONO

- Select "DIN CD" for recording a digital input or "ANALOG" for recording an analog input.

2 Adjust the recording level.

- 1 Play the CD to be recorded.
- 2 Press the MONITOR key



- 3 Adjust the recording level.

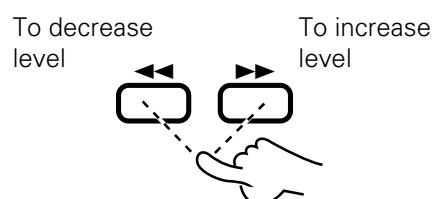

- The recording level can be adjusted even during recording.
- Press the **MONITOR** key again to cancel monitoring.

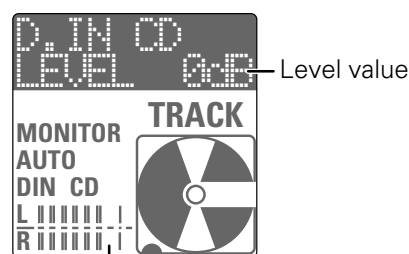

Adjust so that these segments light at times.

- Adjust so that the segments before the vertical bars near the right end of the level meter light occasionally.
- The initial recording level is -12 dB for analog input recording and 0 dB for digital input recording.
- The recording level can also be adjusted using the **rec level** keys on the main unit.

3 Stop CD playback.

4 Put the MD recorder in record-pause mode.





- Press the record (●) key to enter record-pause mode automatically.

5 Play the CD player.

- When the CD playback starts, the MD recording starts automatically.

The input jacks connected with audio cords accept analog signals. This unit records the analog signal from the REC IN jacks by converting it into digital signal. (This recording is simply referred to as analog recording.) When this unit and CD player are connected with an optical fiber cable, the digital signal input through the DIGITAL IN (OPTICAL) jack can be recorded in a digital form (this recording is hereinafter referred to as digital recording). Enjoy high sound quality of digital recording.

- Preparation**
- Open the write protect tab of the Mini Disc to make it recordable. 
 - Check the remaining recording time. 

General recording

1 Set the amplifier's input selector to the source to be recorded.

2 Select the REC INPUT.

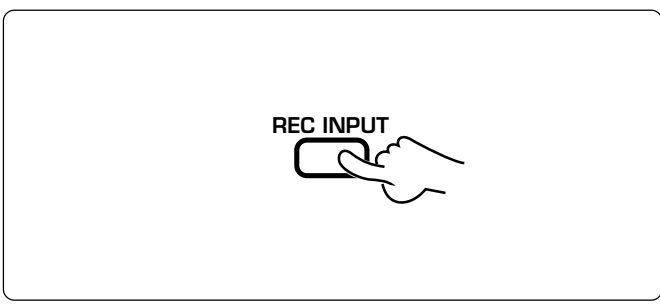



Each press switches the mode. 

- ANALOG
- DIGITAL 1 (DIN CD)
- DIGITAL 2 (DIN AUX)
- MONO

- Select "DIGITAL 1" or "2" for recording a digital input or "ANALOG" or "MONO" for recording an analog input.
- When other components are connected through system control cords, the display becomes as shown inside ().

3 Adjust the recording level.

- 1 Play the source to be recorded. (This operation is not required when recording radio broadcasting.)
- 2 Press the MONITOR key 
- 3 Adjust the recording level.
 To decrease level   To increase level
- 4 Stop the source to be recorded. (This operation is not required when recording radio broadcasting.)

- The recording level can be adjusted even during recording.
- Press the **MONITOR** key again to cancel monitoring.

Example of display when the RD-VH7 is connected through a system control cord

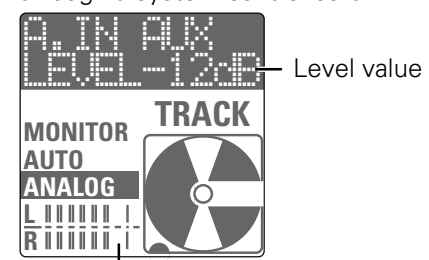

Adjust so that these segments light at times.

- Adjust so that the segments before the vertical bars near the right end of the level meter light occasionally.
- The initial recording level is -12 dB for analog input recording and 0 dB for digital input recording.
- The recording level can also be adjusted using the **rec level** keys on the main unit.

4 Put the MD recorder in record-pause mode.

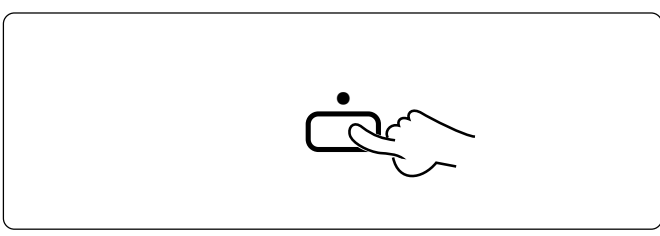

- Press the record (●) key to enter record-pause mode automatically.

5 Start recording.



- When the **EDIT** key is pressed during recording, a track number is inserted in that position.
- Recording can also be started by pressing the **||** or **▶/||** key.

6 Play the source to be recorded. (This operation is not required when recording radio broadcasting.)

7 After recording, eject the Mini Disc.

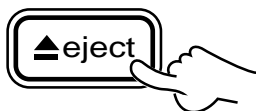

Main unit only

Recording is not possible if the following characters are displayed.

- “**DISC FULL**” : Disc is full
→ Erase undesired tracks. → [40](#)
- “**PROTECTED**” : The accidental erasure protect tab is open.
→ Close it. → [8](#)
- “**PLAY ONLY**” : A playback-only Mini Disc is loaded.
→ Load a recordable Mini Disc.

Digital recording is not possible if the following characters are displayed.

- “**UNLOCK**” : The sampling frequency is not 32 kHz, 44.1 kHz, 48kHz.
→ Use analog recording. → [25](#) → [26](#)
: The optical fiber cable is unplugged or loosened. (The connector is not connected.)
→ Connect the optical fiber cable correctly. → [12](#) → [13](#)
- “**SCMS**” : Digital recording is prohibited by SCMS.
→ Use analog recording. → [25](#) → [26](#)
- “**NOT AUDIO**” : The input digital signal is not an audio signal.



Information is being written.

Mini Disc has been ejected.

Note While “**WRITING**” is displayed, do not apply shock or vibration to the unit because information is being written on the Mini Disc.

To let recording pause temporarily



- Press the same key again to resume recording from the point where it paused.
- Press the **⏮** key to resume recording from about 6 seconds before the point where it paused.
- Recording can also be resumed by pressing the record (●) key.

To stop recording in the middle



During CD recording, the track number is sometimes incremented by 1 when the CD starts to be played. This is caused by a signal contained in the digital signal components recorded on the CD. Unnecessary track numbers can be deleted by referring to “Erasing several tracks at a time (QUICK ERASE)” or “Erasing a single track during playback (ERASE)”. → [40](#) → [42](#)

Starting recording from the sound before the current sound (MEMORY REC)

Recording starts from the sound 6 seconds before the point at which the key is pressed. Use this for example when recording radio programs.

Press while in the recording pause mode.



Recording starts from the sound 6 seconds before the current sound.

- It is not possible to start recording from the sound 6 seconds before the current sound if less than 6 seconds have passed in the recording pause mode.

REC MODE key

The recording-related settings can be adjusted precisely by selecting the proper display modes. **Selecting the setting adjustment mode**

① Switch the REC MODE on.

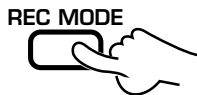

② Select the setting adjustment mode.

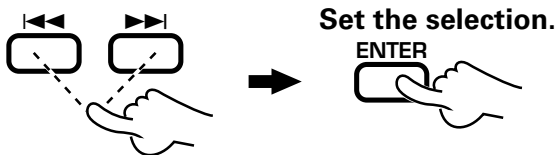

③ Adjust the setting value.

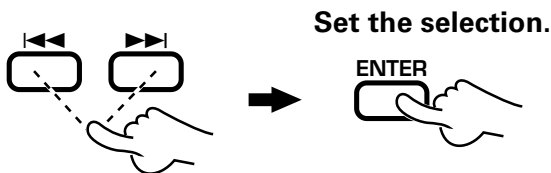

Each press of the **◀◀** or **▶▶** key switches the mode as follows.

- ① **TRACK MARK SET ?** : Setting of the track No. marking method.
- ② **AUTO LEVEL SET ?** : Automatic track number marking no-sound blank detection level setting.

- Step ③ consists of adjusting the setting of the "Setting adjustment mode" selected in step ②.
- To end the setting adjustment, press the **REC MODE** key again.

When "TRACK MARK" is displayed

Pressing the **ENTER** key while "TRACK MARK" is displayed allows to select whether track numbers are marked automatically during recording or manually during or after recording. Select the desired method with the **◀◀** or **▶▶** and press the **ENTER** key to set it. The initial setting is "AUTO". The track numbers can be used when searching or programming tracks in playback.

AUTO

If a no-sound input has lasted for the 2 seconds during recording, the track number will be incremented automatically by "1". Usually, use this position for recording. Use this mode when recording all of the tracks in a CD. When recording music containing a continuous section with a very low level, for example when recording classic music, the track number may be incremented by "1" after such a section. In this case, cancel the track number later. It is recommended to use the **MANUAL** mode when recording such a kind of music.

During digital recording of CD, the track number is incremented automatically by "1" according to the data contained in the digital information. The no-sound blank is not detected.

When the CD track number is increased during manual search of a CD, the track number recorded on the MD may sometimes fail to be incremented.

A no sound track may sometimes created at the moment the played CD stops.

MANUAL

With this setting, the MD track number is not incremented automatically during recording. Track numbers can be marked either during editing (by pressing the **EDIT** key) or after recording (by executing the **DIVIDE** operation - (36)).

This setting is convenient when recording a CD which has been recorded in live or which contains very low-level sound such as a classical music CD.

When "AUTO LEVEL" is displayed

While "AUTO LEVEL" is displayed, pressing the ENTER key displays the initial screen for setting the no-sound blank detection level for automatic track number marking. Now set the no-sound blank detection level with the ◀◀ or ▶▶ key and press the ENTER key to set it. The level set here will be used as the blank detection threshold level. The initial setting is "0" and the level can be set in the range between +3 and -3.

Setting	-3	-2	-1	×0	+1	+2	+3
AUTO TNO	Track number increments less easily ←→ Track number increments more easily						

AUTO TNO (Automatic track number) : Track number increments automatically

Sampling frequency

Three types of digital signals are usually used according to the sampling frequencies. The sampling frequencies vary depending on the types of digital equipment as shown below.

32 kHz : Standard and long-hour modes of DAT, A mode broadcasting of BS tuner, etc.

44.1 kHz : Standard mode of DAT, CD, MD, etc.

48 kHz : Standard mode of DAT, B mode broadcasting of BS tuner, etc.

(DAT : Digital Audio Tape deck)

In general, high-quality recording based on digital signal transmission is not possible unless the source and recorder components use the same sampling frequency. As this unit has a built-in sampling rate converter, digital signals with 32 kHz and 48 kHz can be recorded by conversion to the MD sampling frequency (44.1 kHz).

TIME DISP. key

This key allows to switch the mode of time display.

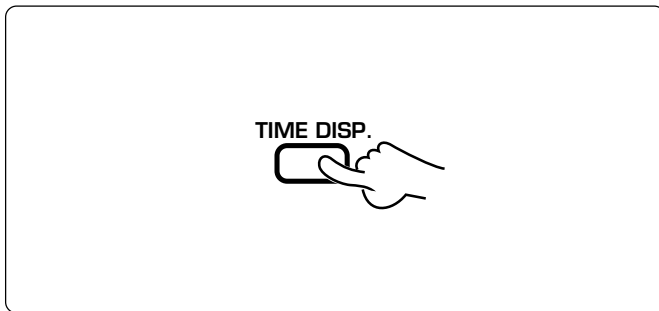

Each press switches the time display modes.

In play/stop mode

- ① **SINGLE(+)** : Elapsed time of a track.
- ② **SINGLE(-)** : Remaining play time of a track.
- ③ **TOTAL(+)** : Total elapsed time of the MD.
- ④ **TOTAL(-)** : Total remaining time of the MD.
- ⑤ **REMAIN** : Remaining recording time of disc.
- ⑥ **TITLE** : Disc title indication (at the time of stop)/
Track title indication (at the time of play-back).

In record mode

- ① **SINGLE(+)** : Elapsed recording time of the track being recorded.
- ② **TOTAL(+)** : Total elapsed time at the time of recording.
- ③ **REMAIN** : Remaining recording time of disc.

MONITOR key

The input source (sound) selected by REC INPUT can be heard.

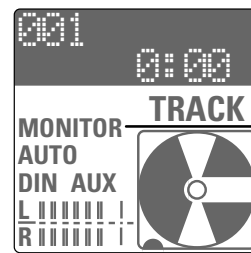
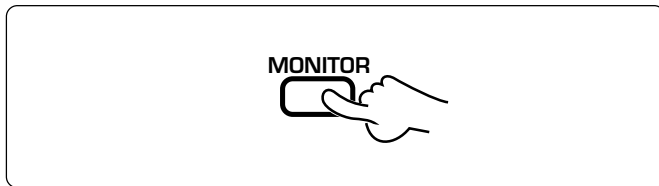

"MONITOR" indicator

- When the sampling frequency of the digital input signal is not 48 kHz, 44.1 kHz, or 32 kHz, "**UNLOCK**" will be displayed and no sound will be heard.
- Monitoring is canceled when a MD starts to play.

REC INPUT switching

ANALOG

: Analog stereo recording of the inputs into the analog recording input. Select this when recording audio from the tuner or cassette deck.

DIGITAL 1 (DIN CD)

: Digital recording of the input into the digital input (OPTICAL) 1. Select this when recording the input from a digital source such as the CD player which is connected through a system control cord.

DIGITAL 2 (DIN AUX)

: Digital recording of the input into the digital input (OPTICAL) 2. Select this when recording the input from a auxiliary digital source such as a BS tuner or DAT recorder.

MONO

: Analog monaural recording of the signals input into the analog recording input. Select this for example when long hours of recording is required.

- In record-pause mode, it is not possible to switch the REC INPUT from "**MONO**" to another position or vice versa.

After recording of a commercially-available recordable Mini Disc, the recording can be edited in various ways. Note that it is impossible to edit a playback-only Mini Disc. (Editing is not possible when "PGM" and "RANDOM" is lit.)

Function Limitations because of the MD Standard
 Some of the functions are limited because of the MD standard. Please check "Symptoms related to MD standard" before assuming a malfunction. → 47

The MD recorder acts based on the data loaded from the disc into the memory. As this data is written in the disc at the moment it is ejected, be sure to eject the disc every time after the title input or editing operation.

Selecting the editing function type

Reordering tracks by moving them

Moving the order of the track being played in a disc (MOVE) → 32
 Reordering several tracks at a time (QUICK MOVE) → 34

Dividing a track, combining two tracks

Dividing a track during playback (DIVIDE) → 36

Combining tracks during playback (COMBINE) → 38

Erasing track(s)

Erasing a single track during playback (ERASE) → 42

Erasing several tracks at a time (QUICK ERASE) → 40

ALL ERASE → 40

This procedure shows you how to play and move a track to the track number you desire. The surrounding tracks are renumbered automatically. Repeating this procedure lets you arrange the tracks in the order you desire.

Preparation ● Play the track to be moved.

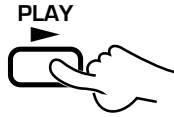

Moving the order of the track being played in a disc (MOVE)

1 Select "MOVE".

① Press the EDIT key.



② Select "MOVE".

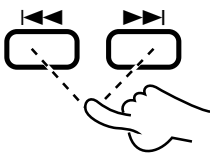

③ Set it.



● This operation is also possible during play-pause.

Each press of the |◀◀ or ▶▶| keys switches the operation.

- ① DIVIDE
- ② COMBINE
- ③ ERASE
- ④ MOVE

● Editing is aborted if no operation has been performed for 8 seconds.



2 Select the moving destination track.

① Select the track number.

To decrease track No.

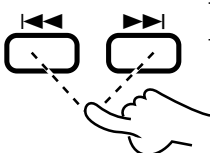

To increase track No.

② Set it.



Example for moving between tracks No. 6 and No. 7

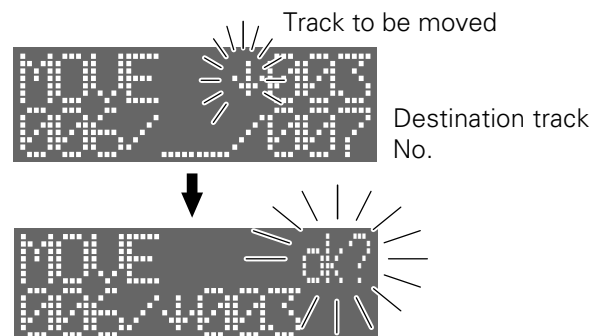

3 Move the track.

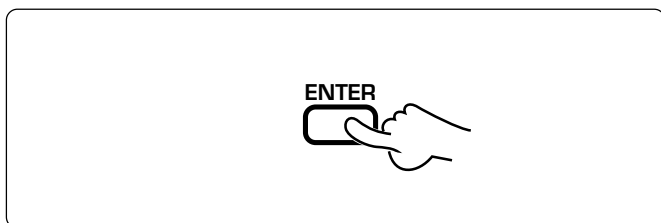

Display after execution

- “EDIT NOW” : Editing
- “COMPLETE” : When editing is completed successfully
- “CAN'T EDIT” : When editing is impossible

- When this operation has been performed unintentionally, return to the status before editing can be made by “EDIT CANCEL” operation. → 33

4 Eject the Mini Disc.

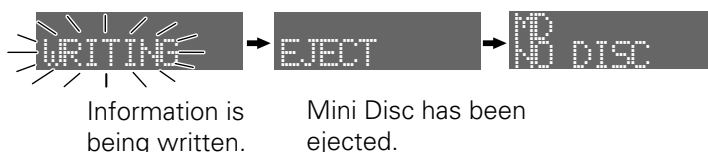
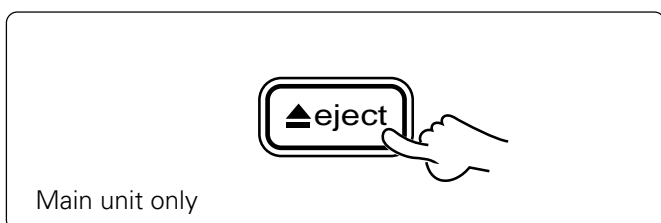

While “WRITING” is displayed, do not impact or move the unit because information about recording and editing is being written to the Mini Disc.

To delete the edited contents (EDIT CANCEL)

When the following key operation is performed before the minidisc is removed, return is possible to the same condition as when the disc was inserted. After cancellation, again perform the individual editing operations.

Operate in stopped condition.

①

②

ok ?

③

- Note that the editing results cannot be canceled if any recording is performed before ejecting the MD or after “**UTOC ERROR**” has been displayed.

Use the following procedure to reorder several tracks in a disc simultaneously by selecting them.

Preparation ● Enter the stop mode.

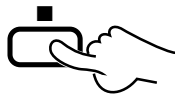

Reordering several tracks at a time (QUICK MOVE)

1 Select "Q.MOVE".

① Press the EDIT key .



② Select "Q.MOVE".

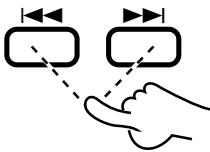

③ Set it.



Each press of the ◀◀ or ▶▶ keys switches the operation.

- ① Q.MOVE
- ② Q.ERASE
- ③ CANCEL

● Editing is aborted if no operation has been performed for 8 seconds.

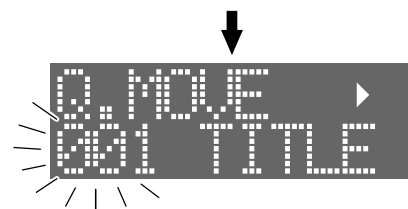

2 Select track numbers in the new order you want.

① Select a track number.

To decrease track No.

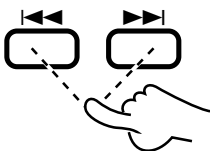

To increase track No.

② Set it.



③ Repeat steps ① and ② above.

④ Complete the selection of track numbers to be reordered.

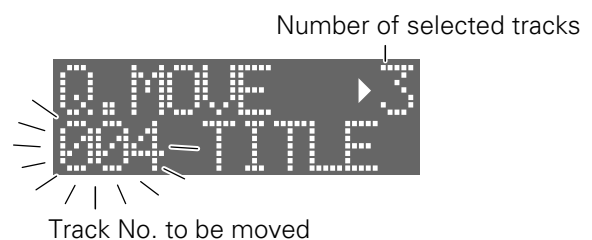

- Up to 32 tracks can be selected.
- Pressing the ◀◀ or ▶▶ key allows to check the current order of tracks.
- Press the **CLEAR/DELETE** key to clear the last selected track number.

3 Execute the track reordering operation.

1 Select the move destination.

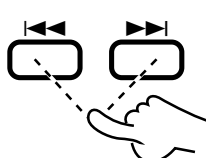

2 Set it



3 Reorder tracks.



Example for moving between tracks No. 5 and No. 6

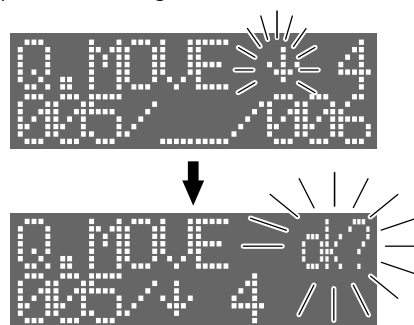

Display after execution

- “EDIT NOW” : Editing
- “COMPLETE” : When editing is completed successfully
- “CAN'T EDIT” : When editing is impossible

- When this operation has been performed unintentionally, return to the status before editing can be made by “EDIT CANCEL” operation. → 33

4 Eject the Mini Disc.

Main unit only

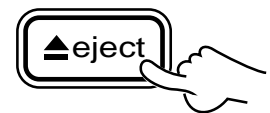
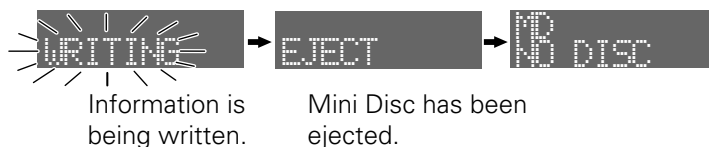
Note While “WRITING” is displayed, do not impact or move the unit because information about recording and editing is being written to the Mini Disc.

Image of Quick Move operation



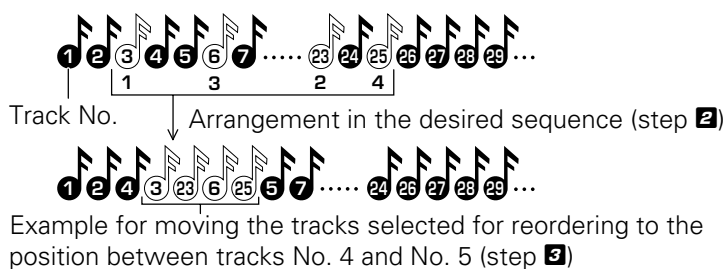

Use the following procedure to divide a track into two by inserting a track number in its middle. For example, by inserting an additional track number before the passage you are specially fond of, it is easy to skip to there when you play the disc later. Note that the track numbers of the tracks located after the divided track are automatically incremented. The preview function can be used for fine adjustment while repeatedly listening to the track division point.

Dividing a track during playback (DIVIDE)

1 Play the track to be divided.

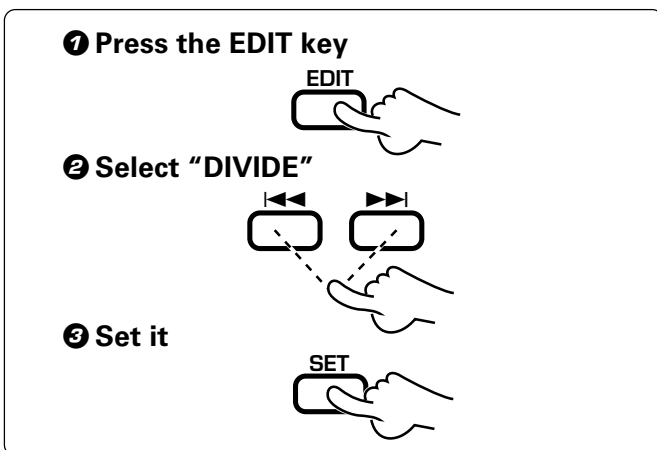
2 Press the **EDIT** key at the desired position.



 If no preview is to be performed, press the **ENTER** key once and then go to step **3**.

3 When preview is to be performed.

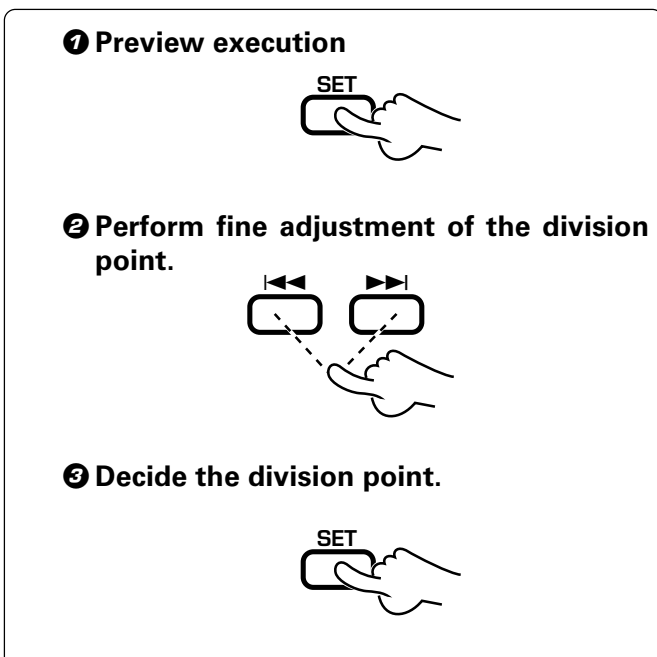

● This operation is also possible during play-pause.

Each press of the **◀◀** or **▶▶** keys switches the operation.

- ① **DIVIDE**
- ② **COMBINE**
- ③ **ERASE**
- ④ **MOVE**

● Editing is aborted if no operation has been performed for 8 seconds.

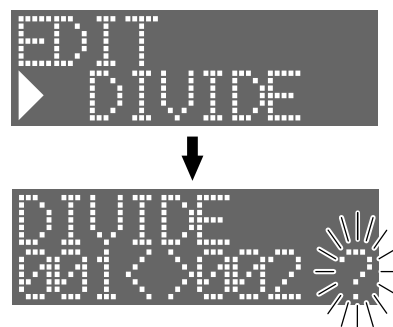

● Repeated playback from the division point will be performed for about 3 sec.



● The dividing point can be fine-adjusted in 60 ms (6/100 sec.) steps, between -31 and +31 assuming that the point where the **EDIT** key was pressed is 0 (i.e. in the range covering about 4 seconds).



4 Execute the track divide operation.

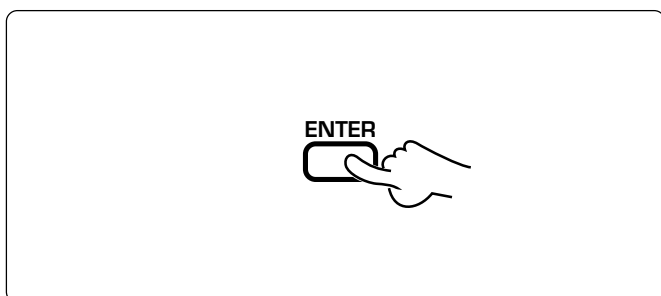

Display after execution

- “EDIT NOW” : Editing
- “COMPLETE” : When editing is completed successfully
- “CAN'T EDIT” : When editing is impossible

- When this operation has been performed unintentionally, return to the status before editing can be made by “EDIT CANCEL” operation. → 33
- There is no blank space left between the two tracks.
- Track division may sometimes be impossible due to the limitations of the MD standard.

Up to 255 track numbers can be inserted additionally by repeating 1 to 4 for each of them.

5 Eject the Mini Disc.

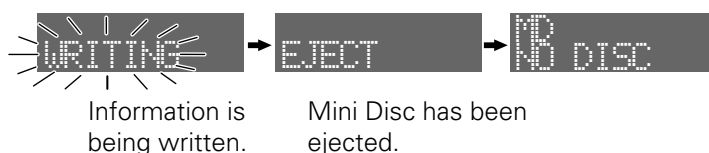
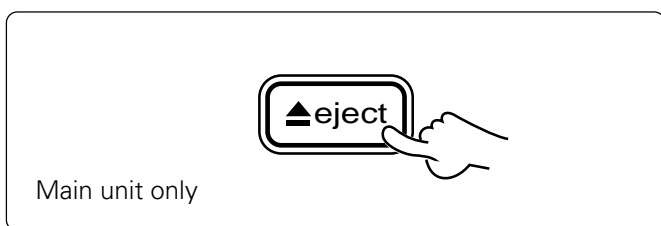

While “WRITING” is displayed, do not impact or move the unit because information about recording and editing is being written to the Mini Disc.

Image of preview

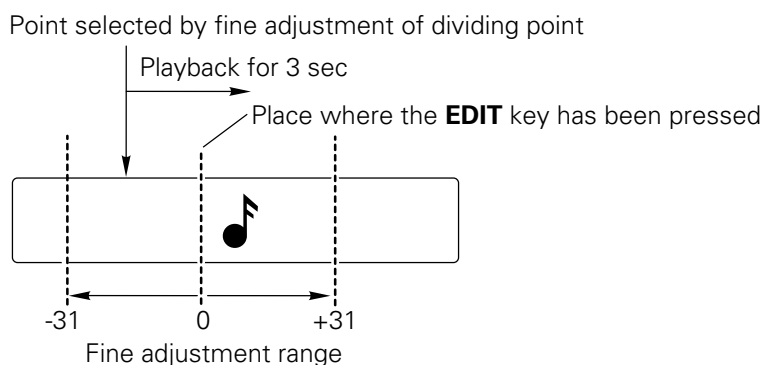

Use the following procedure to combine two tracks into one by deleting a track number. This operation allows to connect several tracks or a piece of music divided into several parts. After this operation, the track numbers of tracks located after the combined tracks are decreased automatically.

Combining tracks during playback (COMBINE)

1 Play the title to be combined.

2 Select "COMBINE".

1 Press the EDIT key



2 Select "COMBINE".

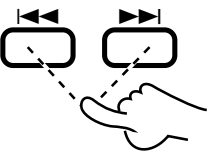



3 Set it.



 When the title being played is to be combined with the next title, press the ENTER key and then go to step **4**.

3 For combining with a different title

1 Select the track number.

To decrease track No.  To increase track No. 

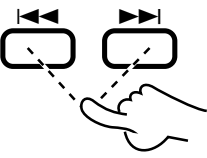

2 Set it.



● This operation is also possible during play-pause.

● If the operation is started during playback, it pauses automatically.

Each press of the  or  keys switches the operation.

- ① DIVIDE
- ② COMBINE
- ③ ERASE
- ④ MOVE

● Editing is aborted if no operation has been performed for 8 seconds.

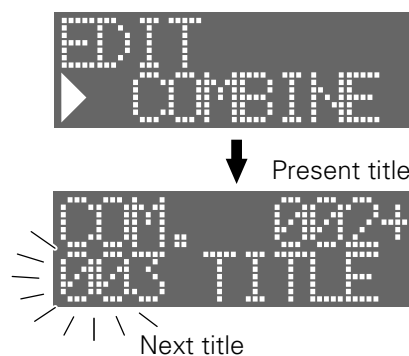

Connecting tracks 2 and 5.

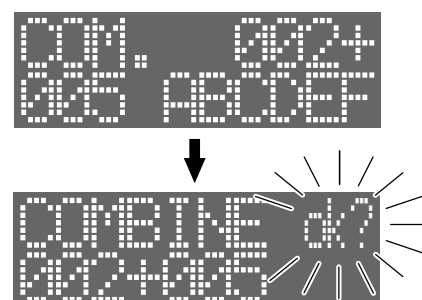

4 Execute the track combine operation.

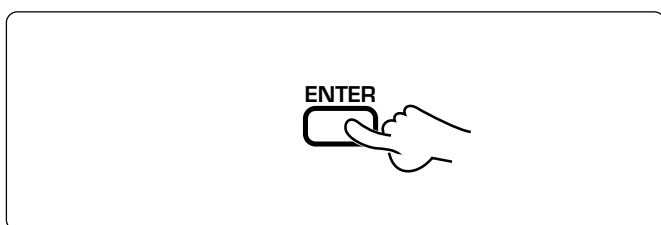

Display after execution

- “EDIT NOW” : Editing
- “COMPLETE” : When editing is completed successfully
- “CAN'T EDIT” : When editing is impossible

- When this operation has been performed unintentionally, return to the status before editing can be made by “EDIT CANCEL” operation. → 33
- Track combining may sometimes be impossible due to the limitations of the MD standard.

5 Eject the Mini Disc.

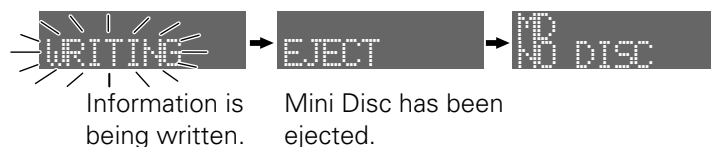
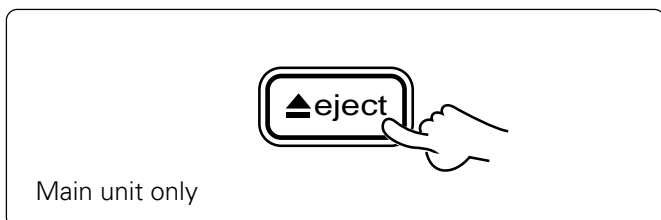

Note While “WRITING” is displayed, do not impact or move the unit because information about recording and editing is being written to the Mini Disc.

The selected track or all tracks can be erased while the player is stop mode. Be careful in using this operation because the erased tracks may not be recovered once it has been erased.

Preparation ● Enter the stop mode.

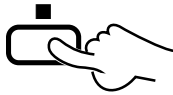

Erasing several tracks at a time (QUICK ERASE)

1 Select "Q. ERASE".

① Press the EDIT key.



② Select "Q.ERASE".

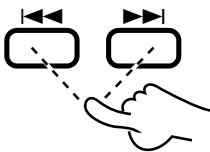

③ Set it.



To erase all tracks, press the ENTER key while "ALL?" is displayed, then go to step 3.

2 Select the title to be erased.

① Select the title to be erased.

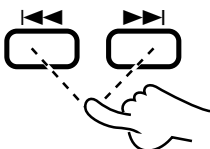

② Set it.



③ Repeat steps ① and ② above.

④ End the selection.



Each press of the ◀◀ or ▶▶ keys switches the operation.

- ① Q.MOVE
- ② Q.ERASE
- ③ CANCEL

● Editing is aborted if no operation has been performed for 8 seconds.

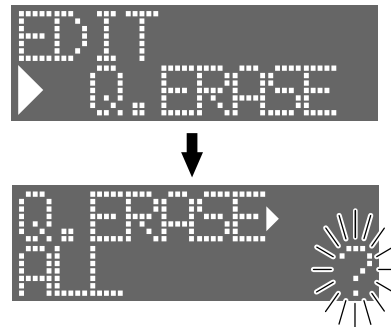

The title to be erased will be displayed.

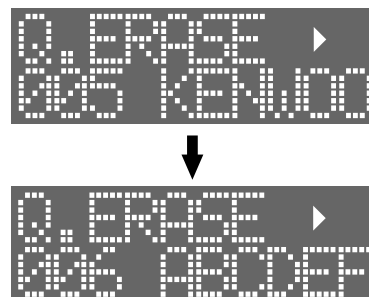

- Up to 32 tracks can be selected.
- Pressing the ◀◀ or ▶▶ keys allow to check the current order of tracks.
- When the **CLEAR/DELETE** key is pressed, the last selected track in the list of tracks to be erased will be cleared from the list.



Number of tracks to be deleted

3 Execute the track erasure operation.

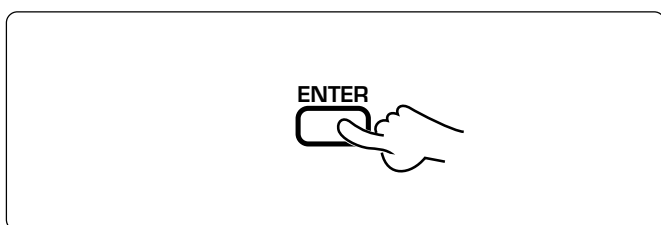

Display after execution

"EDIT NOW" : Editing

"COMPLETE" : When editing is completed successfully

"CAN'T EDIT" : When editing is impossible

- When this operation has been performed unintentionally, return to the status before editing can be made by **"EDIT CANCEL"** operation. → 33

4 Eject the Mini Disc.

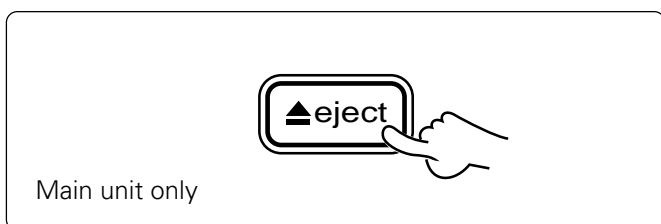

Information is being written.

Mini Disc has been ejected.

Note While **"WRITING"** is displayed, do not impact or move the unit because information about recording and editing is being written to the Mini Disc.

Use the following procedure to erase all of the MD tracks while the player is in stop mode. Be careful in using this operation because the erased tracks may not be recovered once it has been erased.

Preparation ● Play the title to be erased.

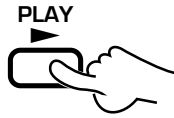

Erasing a single track during playback (ERASE)

1 Select "ERASE".

① Press the EDIT key ② Select "ERASE"

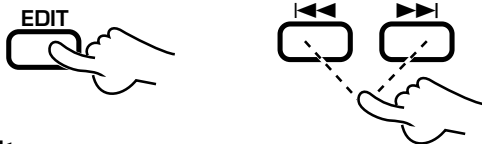

③ Set it.



Each press of the |◀◀ or ▶▶| keys switches the operation.

- ① DIVIDE
- ② COMBINE
- ③ ERASE
- ④ MOVE

● Editing is aborted if no operation has been performed for 8 seconds.



2 Execute the track erasure operation.

① Confirmation of erasing ② Execute the track erasure operation.

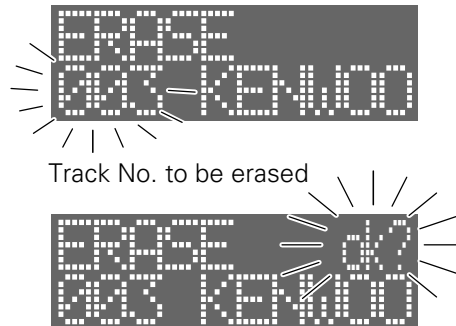

Track No. to be erased

● The track being played is erased (together with its track title).

3 Eject the Mini Disc.

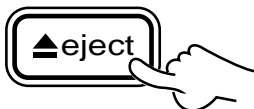

Main unit only

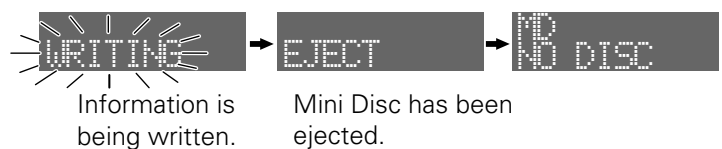

Note While "WRITING" is displayed, do not impact or move the unit because information about recording and editing is being written to the Mini Disc.

When titles are assigned to a disc and its tracks, the titles cannot only be displayed during playback but title search (searching a track by the title) is also made possible. The assigned titles can be changed or deleted with the same procedure.

Title Memo

The Title Memo makes it possible to register frequently used titles and the titles you like for facilitating the title editing operations.

Title Copy

The Title Copy makes it possible to copy disc titles and track titles recorded in MDs.

How to edit titles

1 Activate the title input mode.

1 Press the TITLE INPUT key.

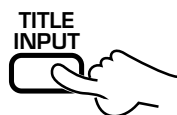

2 Select the title to be edited.

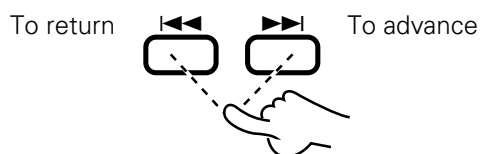

3 Set the selection.



To abort operation, press the TITLE INPUT key again.

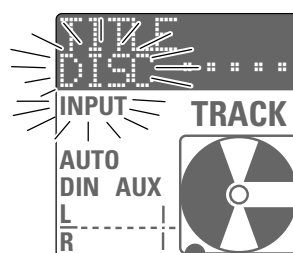

Each press of the |◀◀ or ▶▶| keys switches the operation.

- ① DISC (Disc title)
- ② 001 (Track title)
- ③ ALL ERASE (Complete erasure of disc and track titles)
- ④ [1] (Title Memo)

In case of disc title :

Select "DISC".



In case of track title :

Select the desired track No.

(The track can also be selected using the numeric keys.)



Complete erasure of disc and track titles :

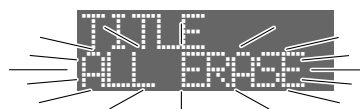

To register the title in the Title Memo :

Select one of [1], [2] or [3].



Total number of title characters

Up to 1792 characters can be input per disc and up to 80 characters can be input per track. (In case of alphanumeric and symbol characters) A space (blank character) also required the same amount of data as alphanumeric characters. When deleting a title, it is not recommended to overwrite spaces on previous characters but use the (CLEAR/DELETE) function.

2 Input the title.

To select characters with the ◀◀ and ▶▶ keys

If any of **Aa** or **12** is displayed, press the ◀◀ or ▶▶ key.

To enter a title

- 1 Select a character group.



- 2 Select a character.

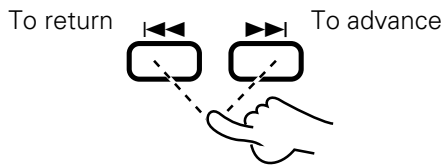

- 3 Set the selected character.



- 4 Repeat steps 1 to 3 above.

To change or clear a title

- 1 Move the character to the desired character (to be changed).

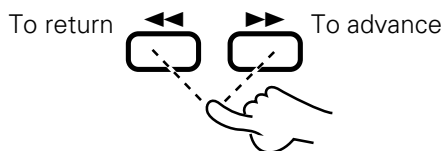

- 2 Delete the character.



- 3 Perform steps 1 to 2 of "To enter a title".

Press the P.MODE/CHARAC. key for the required number of times to select one of the character groups below.  46

- A~Z, space (1 blank character)
- a~z, space
- 0~9, symbols
- Title Memo (3 types), Title Copy (disc title, track title)

- The display can be scrolled so that any character (in a single group) can be selected.

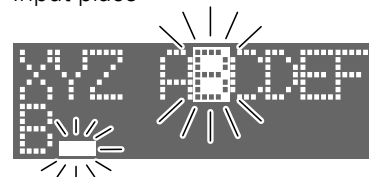
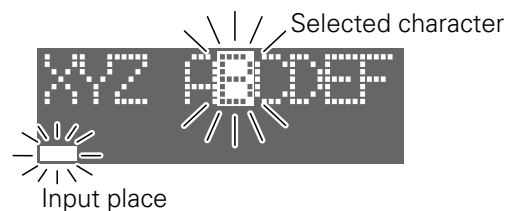

The cursor moves and stands by for the next character input.

- Use the ◀◀ or ▶▶ key to move the input position cursor to the left or right.
- To enter a space character, press the **CHECK/SPACE** key.

To select characters with the numeric keys

If none of  or  is displayed, press one of the numeric keys.
To enter a title

① Select a character group.



② Select a character.

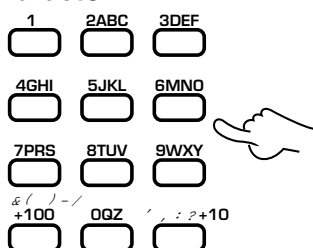

When the same key is pressed repeatedly, the characters will change.

(Example : When  is pressed, the characters will change in the order of **A→B→C→a→b→c.**)

- If you made a mistake, press the **CLEAR/DELETE** key.

③ Set the selected character.



④ Repeat steps ① to ③ above.

To change or clear a title

① Move the character to the desired character (to be changed).

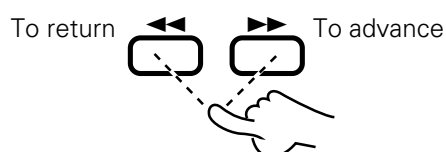



② Delete the character.



③ Perform steps ① to ④ of "To enter a title".

Press the **P.MODE/CHARAC.** key for the required number of times to select one of the character groups below. → 

 : **A~Z**, symbols, Title Memo (3 types)

 : **0~9**, symbols



Input place

- Use the **◀◀** or **▶▶** key to move the input position cursor to the left or right.
- To enter a space character, press the **CHECK/SPACE** key.



The cursor moves and stands by for the next character input.

- The character can be set also by pressing another numeric key, **▶▶** key or the **P.MODE/CHARAC.** key.

3 Execute title change or deletion.

① Enter the title in memory.



② Complete the operation.

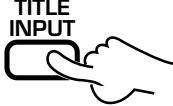

The title is scrolled automatically.

4 Eject the Mini Disc.

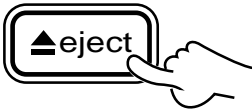

Main unit only



Information is being written.

Mini Disc has been ejected.

Note While "WRITING" is displayed, do not impact or move the unit because information about recording and editing is being written to the Mini Disc.

List of characters available for title editing

The following alphabets and symbols can be selected for use in title editing.

When selecting characters with the ◀◀ and ▶▶ keys on the remote control unit

English uppercase letter group	ABCDEFGHIJKLMNOPQRSTUVWXYZ Space
English lowercase letter group	abcdefghijklmnopqrstuvwxyz Space
Numeral/symbols group	0123456789 Space ! " # \$ % & ' () * + , - . / : ; < = > ` ? @ ^ _
Title Memo/Title Copy group	[1] [2] [3] [DISC] ([001]●●●●)

When selecting characters with the numeric keys on the remote control unit

key	group		
1	Space [1] [2] [3]		1
2ABC	ABCabc or abcABC		2
3DEF	DEFdef or defDEF		3
4GHI	GHIghi or ghiGHI		4
5JKL	JKLjkl or jklJKL		5
6MNO	MNOmno or mnoMNO		6
7PRS	PRSprs or prsPRS		7
8TUV	TUVtuv or tuvTUV		8
9WXY	WXYwxy or wxyWXY		9
0QZ	QZqz or qzQZ		0
' , : ? +10	' , : ? ! ; . " _ ` \$ ^		
& () - / + * 100	& () - / + * = < > # % @		

● Title Copy cannot be selected with the numeric keys.

What appears to be a malfunction may not always be serious. If your unit should not perform as expected, consult the table below to see if the problem can be corrected before seeking help from your dealer or service representative.

Operation to reset

The microprocessor may fall into malfunction (impossibility to operate erroneous display, etc.) when the power cord is unplugged while power is ON or due to an external factor. In this case, execute the following procedure to reset the microprocessor and return it to normal condition.

Unplug the power cord from the power outlet then, while holding the eject (▲ eject) key depressed, plug the power cord again.

- Please note that resetting the microprocessor clears the contents stored in, it returns the microprocessor to the condition when it left the factory.

Symptoms related to MD standard

Symptom	Cause
"DISC FULL" is displayed before the maximum recording time of MD is reached.	<ul style="list-style-type: none"> ● More than 255 tracks (track No. 256 or more) cannot be recorded. (There may be also cases in which recording is impossible while the track number is less than 256.) ● If information such as emphasis data is switched on and off frequently in a track, it is handled as boundaries between tracks and "DISC FULL" may be displayed regardless of the recording time or the actual number of tracks. In such a case, the REMAIN time display shows "0:00".
The recordable time does not increase after a short track has been erased.	<ul style="list-style-type: none"> ● The remaining time display becomes "0:00" when the actual total remaining time of the Mini Disc is less than 12 seconds. The recordable time display changes when the total time of the erased track exceeds 12 seconds. ● When a Mini Disc has been subjected to repeated editing, the remaining time may not increase even after a short track has been erased.
Tracks cannot be combined.	<ul style="list-style-type: none"> ● A track created as a result of an editing operation may sometimes be impossible to be combined with another track.
The total of the recorded time and recordable time does not coincide with the total recording time of the MD.	<ul style="list-style-type: none"> ● As recording is performed on a minimum recording basis of 2 seconds, the displayed time may not coincide with the consumed disc capacity.
Sound is interrupted when a track created by editing is subjected to fast forward or fast backward operation.	<ul style="list-style-type: none"> ● Sound interruption may occur due to a combination of various factors, and it is not a malfunction.
Tracks are not numbered correctly.	<ul style="list-style-type: none"> ● A short track may be created depending on the contents of the recorded source (CD, for example).
The period in which "READING" is displayed is abnormally long.	<ul style="list-style-type: none"> ● "READING" is displayed for a longer period than usual when a brand-new recordable Mini Disc (a virgin disc) is loaded. ● The Mini Disc in use has been processed with repeated editing or contains a large number of tracks.
The displayed time is incorrect when a monaurally-recorded Mini Disc is played.	<ul style="list-style-type: none"> ● This is because the monaural recording and stereo recording use different formats, and not a malfunction.
The total number of characters used in the titles is less than 1792 characters.	<ul style="list-style-type: none"> ● As the title recording areas are used on a per-7-character basis, the total number of input characters may be less than 1792.

Displayed messages and actions to be taken against them

Displayed Message	Meaning	Action
UNLOCK	<ul style="list-style-type: none"> ● An attempt is made to record digital signal from a source using other sampling frequency than 38kHz, 44.1 kHz, 48 kHz. ● The optical fiber cable is unplugged or loose. (The connector is not connected.) 	<ul style="list-style-type: none"> ● Use analog recording. → 25 26 ● Connect the optical fiber cable correctly. → 12 13
SCMS	<ul style="list-style-type: none"> ● An attempt is made to record digital signal from a source while its digital copy has been prohibited by SCMS. 	<ul style="list-style-type: none"> ● Use analog recording. → 25 26
DISC FULL	<ul style="list-style-type: none"> ● There is no recordable area on the disc. ● An attempt is made to record a 256th track. 	<ul style="list-style-type: none"> ● Use another recordable disc. ● More than 255 tracks cannot be recorded per disc.
— — —	<ul style="list-style-type: none"> ● The disc does not contain any recordings. 	<ul style="list-style-type: none"> ● When playback is required, use a recorded disc.
READING	<ul style="list-style-type: none"> ● The TOC*1 data of the disc is being read. 	<ul style="list-style-type: none"> ● This is a normal operation.
WRITING	<ul style="list-style-type: none"> ● The data related to editing or recording is being written in the disc. 	<ul style="list-style-type: none"> ● This is a normal operation.
UTOC ERROR	<ul style="list-style-type: none"> ● The contents of UTOC*2 are abnormal. 	<ul style="list-style-type: none"> ● Perform "QUICK ERASE" to delete all titles "ALL?". If this is not possible, use another disc. → 40
CAN'T EDIT	<ul style="list-style-type: none"> ● An attempt is made to perform editing beyond the restrictions, for example to erase a track which is too short. 	<ul style="list-style-type: none"> ● Perform editing following the restrictions.
ok? (blinking)	<ul style="list-style-type: none"> ● This is a message for confirming if editing can really be executed. 	<ul style="list-style-type: none"> ● Press the ENTER key to execute editing.
PROTECTED	<ul style="list-style-type: none"> ● The write protect tab is open. 	<ul style="list-style-type: none"> ● Close the write protect tab. → 8
PLAY ONLY	<ul style="list-style-type: none"> ● A playback-only Mini Disc is loaded. 	<ul style="list-style-type: none"> ● Load a recordable Mini Disc.

Other symptoms

Symptom	Cause	Remedy
Sound is not output even when the play key is pressed.	<ul style="list-style-type: none"> ● The cords are connected erroneously. ● No disc has been loaded. ● A non-recorded disc has been loaded. 	<ul style="list-style-type: none"> ● Connect the cords in accordance with "System connections". → → ● Load a disc. → ● Load a prerecorded disc or playback-only disc.
Recording is not possible	<ul style="list-style-type: none"> ● The disc is write-protected. ● An attempt is made to record digital signal from a source while its digital copy has been prohibited by SCMS. ● The recording level is too low (in case of analog recording). ● A playback-only disc has been loaded. ● The disc does not have a recordable area. ● The REC INPUT key is not set to the actual input source. ● If the amplifier is connected to this unit through a system control cord, the amplifier's input selector is set to the MD input. 	<ul style="list-style-type: none"> ● Change the position of the write protect tab to the write position or use a recordable disc. → ● Use analog recording. → → ● Adjust the recording level again. → → ● Use a recordable disc. ● Use another disc. ● Set it according to the actual input source. → → ● Set the amplifier's input selector to other position than MD.
Sound is distorted.	<ul style="list-style-type: none"> ● The recording level has not been adjusted. ● A disc in which distorted sound has been recorded is played. 	<ul style="list-style-type: none"> ● Read "Adjust the recording level". → → ● Use another disc.
Noise is noticeable.	<ul style="list-style-type: none"> ● An external noise is induced. 	<ul style="list-style-type: none"> ● Install the unit at a position apart from an electric appliance or TV set.



*1 : All minidisks contain a Table of Contents (TOC) in addition to sound signals. The TOC is similar to the table of contents in a book and contains information, such as track numbers, track length, and character information, that cannot be rewritten. →

*2 : In addition to the TOC, minidisks also contain a special User's Table of Contents (UTOC) that contains track number, track length, and character information, that can be rewritten. →

[Format]

System	Minidisc digital audio system
Laser	Semiconductor laser
Recording method	Field modulation overwrite method
Audio compression	ATRAC (Adaptive TRansform Acoustic Coding)
Playing rotation	Approx. 400 rpm ~ 900 rpm (CLV)

[D/A conversion]

D/A conversion	20 Bit
Oversampling	128 fs (44.1 kHz)

[A/D converter]

A/D conversion method	Sigma-delta method
Sampling frequency	44.1 kHz

[Digital audio performance]

Frequency response (playback mode)	8 Hz ~ 20 kHz, ± 1 dB
Signal to noise ratio (playback mode)	More than 95 dB
Dynamic range (playback mode)	More than 90 dB
Wow & flutter	Less than unmeasurable limit
Analog input sensitivity / input impedance	300 mV / 47 kΩ
Analog output level / load impedance	1.2 V / 3.2 kΩ
Digital input	
Optical(Wave length 660 nm)	- 15 dBm ~ - 21 dBm

[General]

Power consumption	12 W
Dimensions	
(Horizontal installation)	W : 247 mm (9 - 3 / 4") H : 96 mm (3 - 3 / 4") D : 279 mm (11")
(Vertical installation)	W : 96 mm (3 - 3 / 4") H : 237 mm (9 - 5 / 16") D : 279 mm (11")
Weight (Net)	3.1 kg (6.8 lb)



1. KENWOOD follows a policy of continuous advancements in development. For this reason specifications may be changed without notice.
2. The full performance may not be exhibited in an extremely cold location (under a water-freezing temperature).

KENWOOD

For your records

Record the serial number, found on the back of the unit, in the spaces designated on the warranty card, and in the space provided below. Refer to the model and serial numbers whenever you call upon your dealer for information or service on this product.

Model _____ Serial Number _____