

SHARP



1-BIT PORTABLE MINIDISC RECORDER

MODEL

IM-DR410E

OPERATION MANUAL

If you require any advice or assistance regarding your Sharp product, please visit our web-site www.sharp.co.uk/customersupport. Customers without Internet access may telephone 08705 274277 during office hours (or (01) 676 0648 if telephoning from Ireland).

Thank you for purchasing this SHARP product.
For the best performance, read this manual carefully.
It will guide you in operating your SHARP product.

**MDLP****NetMD**TINSE0550AWZZ
03G R YT ①

Special Notes

NOTES FOR USERS IN THE U.K. AND IRELAND

SERVICE INFORMATION

In the unlikely event of your equipment requiring repair, please use the supplied postage paid label to send your unit to the Sharp repair centre or contact the dealer or supplier from whom it was purchased. Where this is not possible, please visit our web-site www.sharp.co.uk/customersupport.

Customers without internet access may telephone 08705 274277 during office hours (or (01) 676 0648 if telephoning from Ireland).

Please note; all calls will be charged at local rate.

Certain replacement parts and accessories may be obtained from our main parts distributor.

WILLOW VALE ELECTRONICS LTD.
0121 766 5414

In the unlikely event of this equipment requiring repair during the guarantee period, you will need to provide proof of the date of purchase to the repairing company. Please keep your invoice or receipt, which is supplied at the time of purchase.

■ Warnings

- The supplied AC adaptor contains no user serviceable parts. Never remove covers unless qualified to do so. It contains dangerous voltages, always remove the mains plug from the main outlet socket before any service operation or when not in use for a long period.
- The AC adaptor supplied with the IM-DR410E must not be used with other equipment.
- To prevent fire or shock hazard, do not expose this appliance to dripping or splashing liquids. No objects filled with liquids, such as vases, shall be placed on the apparatus.
- Never use an AC adaptor other than the one specified. Otherwise, problems or serious hazards may be created.

■ Caution

- When recording important selections, make a preliminary test to ensure that the desired material is properly recorded.
- SHARP is not liable for damage or loss of your recording arising from malfunction of this unit.

IM-DR410E

1

- At full volume, prolonged listening to a personal stereo may damage the user's hearing. This model complies with the law if used with the correct earphones (model number RPHOH0026AWZZ). If the earphones are damaged in any way, please order using the model number given above.
- This product is classified as a CLASS 1 LASER PRODUCT.
- Use the Portable MiniDisc Recorder only in accordance with the instructions given in this manual and do not attempt to interfere with the interlock switch or make any other adjustment as this may result in exposure to hazardous radiation.

Laser Diode Properties

- Material: GaAlAs
- Wavelength: 785 nm
- Pulse time:
Read mode: 0.8 mW Continuous
Write mode: max 12 mW 0.5S
min cycle 1.5S
Repetition

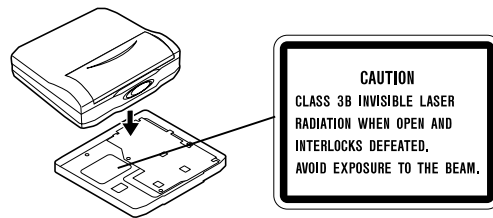

Notes

- Recording and playback of any material may require consent, which SHARP is unable to give. Please refer particularly to the provisions of the Copyright Act 1956, the Dramatic and Musical Performers Protection Act 1958, the Performers Protection Acts 1963 and 1972 and to any subsequent statutory enactments and orders.
- This equipment complies with the requirements of Directives 89/336/EEC and 73/23/EEC as amended by 93/68/EEC.
- US and foreign patents licensed from Dolby Laboratories.
- The letters in brackets contained in the model number indicate the colour of the product only. Operation and specifications are unaffected.

Important Introduction
-Special Notes-

3

Features

■ A Portable MD player with "Mobile 1-bit digital amplifier"

- The 1-bit digital signal is sent to a constant voltage circuit directly from a high-order $\Delta\Sigma$ modulation circuit. The amplifier transmits and amplifies the signal, and allows extremely natural and clear sound with little deterioration.
- High-quality sound is achieved by vast improvements in the sound resolution. The speed and the smoothness of rise of the sound are consequently ensured.

■ "4-pole plug earphone" optimizes "Mobile 1-bit digital amplifier"

- Sharp has adopted "4-pole plug" earphone that completely separate right and left sound. Enjoy the high quality sound of the "Mobile 1-bit digital amplifier".

4-pole plug for mobile
1-bit digital amplifier

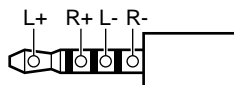

■ A Net MD portable recorder

Audio data saved on the hard disk of a PC can be transferred to a Net MD-compatible recorder using the provided software "BeatJam".

■ This product features up to 50 times high speed transfer from PC to MD in LP4 mode

- Transfer speed varies by the recording mode. In SP mode, the speed is less than 1/4 of that in LP4 mode.
- Time for initialisation and the termination process is omitted from the calculation of transfer speed.
- To achieve maximum speed, use the AC adaptor and a high capacity battery together.
- Transfer speed depends on the performance of your PC or the number of tracks to record.

Contents

IM-DR410E

	Page		Page
■ Important Introduction		■ Net MD	
Accessories	6	About Net MD	38 - 39
Names of Controls and Indicators	7 - 8	System Requirements	40
Precautions	9	Software Installation	41
		Connecting to a PC	42 - 43
■ Power Source		Transferring Data	44
Using with the AC Adaptor	10		
Using with the Alkaline Battery	10	■ References	
		MiniDisc System Limitations	45
■ Preparation		Error Messages	46 - 47
Inserting a MiniDisc	11	Troubleshooting	48 - 49
Connections	12 - 13	Maintenance	49
Hold Function	14	Specifications	50 - 51
Before Recording	15		
■ Basic Operation			
Recording	16 - 17		
Playback	18 - 19		
■ Useful Features			
Advanced Playback	20 - 21		
Advanced Recording	22 - 26		
Changing Default Settings	27		
Checking Displays	28 - 29		
■ Advanced Features			
Titling a MiniDisc	30 - 33		
Editing a Recorded MiniDisc	34 - 36		
Listening through Another System	37		
Resuming auto play	37		

The operation manual of this product consists of 2 volumes.

Unit operation manual:
Guides you through preparation and operation of this system. Be sure to read this before operating the unit.









BeatJam:
Guides you through operation of the bundled software "BeatJam".

Important Introduction
-Contents-

1

5

Accessories

 <p>4-pole plug</p> <p>Earphones x 1</p>	 <p>AC Adaptor (RADPA8066AWZZ) x 1</p>	 <p>Connection Cable (for digital recording) x 1</p>	 <p>Connection Cable (for analogue recording) x 1</p>
 <p>4-pole plug</p> <p>Output Conversion Cable (4-pole to 3-pole plug conversion) x 1</p>	 <p>Carrying Bag x 1</p>	 <p>CD-ROM x 1</p>	 <p>USB Connection Cable x 1</p>

Notes:

- You can hear the sound only from one earphone if you use the supplied earphones with other equipment.
- Parts and equipment mentioned in this operation manual other than those detailed above are not included.
- The AC adaptor may be different from the one in the drawing.

Names of Controls and Indicators

IM-DR410E

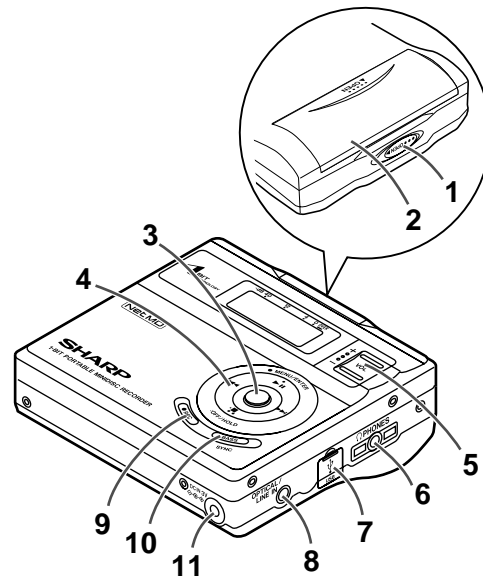

■ Main unit

	Reference page
1. Open Lever	11
2. Battery Cover	10
3. Menu/Enter Button	17, 19, 30
4. Play/Pause/Stop/Power Off/Hold/ Fast Forward/Fast Reverse/ Recording Level/Menu Select/ Name Select Button	14, 16, 18, 20, 30
5. Volume/Cursor Button	19, 31
6. Earphones/Line Output Socket	18, 37
7. USB Socket	42
8. Optical/Line Input Socket	12
9. Record/Track Mark Button	16, 24, 25
10. Bass/Delete/Synchro Button	19, 24, 31
11. 3 V DC Input Socket	10

Note:

When the battery cover comes off, attach the cover back as shown below.

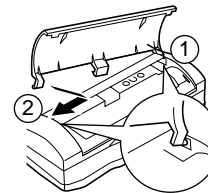

Important Introduction
-Names of Controls and Indicators-

Names of Controls and Indicators (continued)

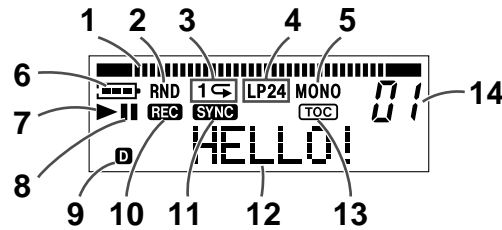

■ Display panel

	Reference page
1. Level Meter	16
2. Random Indicator	21
3. Repeat Indicator	21
4. Long-Play/Recording Mode Indicator	22
5. Monaural Mode Indicator	22
6. Battery Indicator	29
7. Play Indicator	18
8. Pause Indicator	16
9. Disc Name Indicator	28
10. Record Indicator	16
11. Synchro Recording Indicator	24
12. Character/Time Information Indicator	16, 28
13. TOC Indicator	15
14. Track Number Indicator	16

Precautions

IM-DR410E

1

■ Important

- Do not wear your earphones when you are crossing streets or near traffic.
- Do not use your earphones whilst driving a motor vehicle, it may create a traffic hazard and may be illegal. Remember to obey all of the safety rules in your area.
- Do not play the unit at a high volume. Hearing experts advise against extended listening at high volume levels.
- If you experience ringing in your ears, reduce the volume or discontinue use.
- No naked flame sources, such as lighted candles, should be placed on the apparatus.
- Attention should be drawn to the environmental aspects of battery disposal.
- The apparatus is designed for use in moderate climate.
- This portable MD should only be used within the range of 0°C - 40°C (32°F - 104°F).



To avoid accidental electric shock or other possible problems, observe the precautions listed below.

- Do not disassemble or modify the unit.
- Do not drop or subject the unit to shock.
- Do not use the unit near open flames.
- Do not spill liquid on the unit.
- Do not use an external power supply, other than the 3 V DC supplied with this unit, as it may damage the unit.
- SHARP is not responsible for damage due to improper use. Refer all servicing to a SHARP authorised service centre.

■ Storing the unit

Avoid using or leaving the unit in the following places.

- Places exposed to direct sunlight for many hours (especially in cars with the doors and windows closed) or near heaters. (The cabinet may deform, change colour or the unit may malfunction.)
- Places exposed to excessive dust.
- Places exposed to water.
- Places where temperatures are excessively high or low.
- Places (bathrooms) where the humidity is extremely high.
- Places with strong magnetic fields such as TVs or loudspeakers.
- Places exposed to vibration.
- Places where sand can easily enter the inside of the unit (beaches etc.).
- If the unit is used near radio tuners or TVs, noise and/or picture interference may result. If you experience these problems, move the unit away from such devices.

It is not recommended to put the portable MD into a rear pocket, as this may damage the product when sitting.



Using this unit near mobile phones may cause noise pickup. If it occurs, move it away from them.



Important Introduction
-Precautions-

9

Using with the AC Adaptor

Plug the AC adaptor into the wall socket, and then insert the plug on the other end into the DC IN 3V socket.

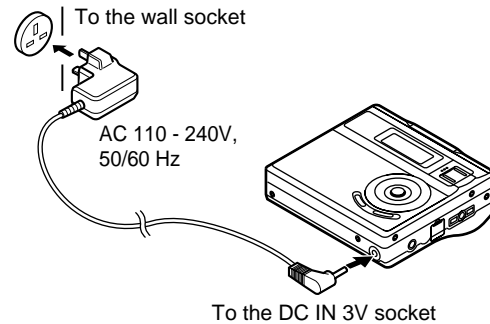

Caution:

- Insert the plugs firmly.
- When the unit is not in use for extended periods, remove the AC adaptor from the wall socket.

Note:

If power failure occurs whilst playing a disc using the AC adaptor, disconnect it from the wall socket. Otherwise, playback may start automatically when electricity resumes.

Using with the Alkaline Battery

Use one commercially available alkaline battery (LR6, "AA" size).

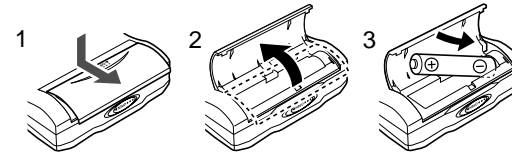

- 1 Push and slide the battery cover.**
- 2 Open the battery cover.**
- 3 Insert an alkaline battery according to the direction indicated in the battery compartment.**

When inserting or removing the battery, push it towards the \ominus battery terminal.

- 4 Close the battery cover.**

Notes:

- Do not replace the battery during operation.
- **Do not use a nickel-cadmium battery.**
- Remove the battery if the unit will not be used for long periods of time. This will prevent potential damage due to battery leakage.
- Installing the battery incorrectly may cause the unit to malfunction.

Inserting a MiniDisc

- 1** Slide the OPEN lever to release the compartment door.
- 2** Lift up the compartment door.
- 3** Insert a MiniDisc.
Insert according to the direction arrow.
- 4** Close the compartment door.

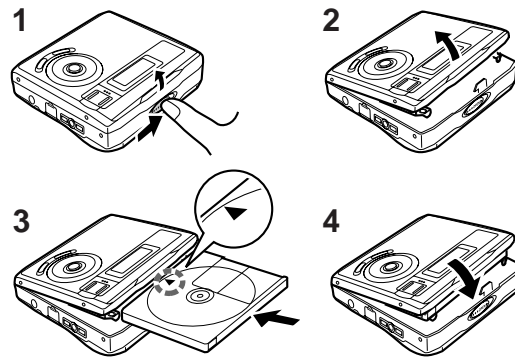

Notes:

- Do not place the MiniDisc under the holder.

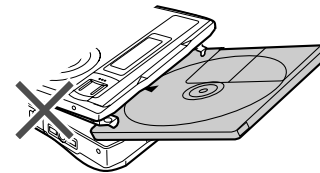

- If any resistance is felt, do not force the MiniDisc into the unit, as it may cause damage to the unit. If resistance is felt, remove the MiniDisc and reload it.
- The lid cannot be opened if "TOC" is displayed; refer to the instruction on page 15.
- When you record on a MiniDisc, check that the erase prevention tab is set to the "Recordable" position.



IM-DR410E

Preparation
-Inserting a MiniDisc-

2

Connections

You can record your favourite CDs or tapes to MD.
When recording, it is recommended to use the AC adaptor and also install the battery. Should the power failure occur, the power source would be automatically switched to the battery.

■ **To connect to a stereo system with "LINE OUT" or "AUDIO OUT" sockets (analogue connection)**

If the audio system has only one pair of sockets, they are usually for input only and recording via this connection is not possible.

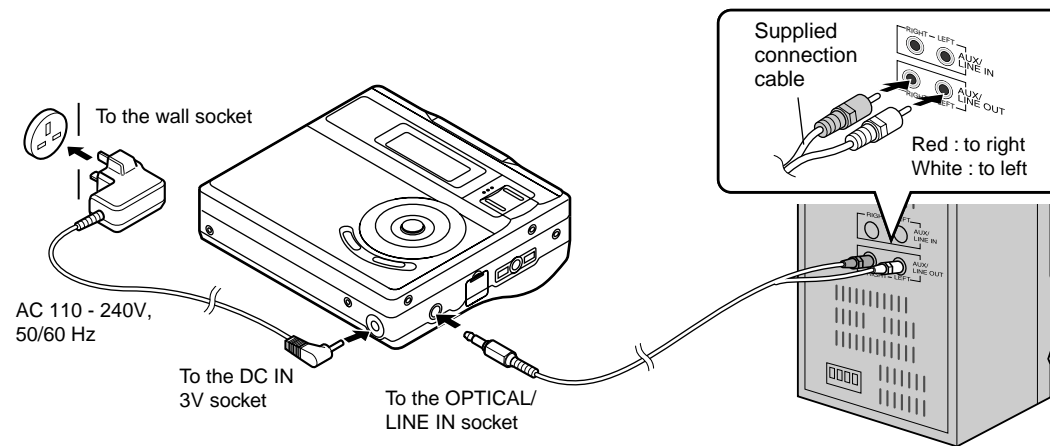

■ **To connect to a stereo system with a "DIGITAL OUT" or "OPTICAL OUT" socket (digital connection)**

When compared with an analogue connection recording, using a digital connection will give higher quality.

Some audio systems do not have a DIGITAL OUT socket.

Check before connecting.

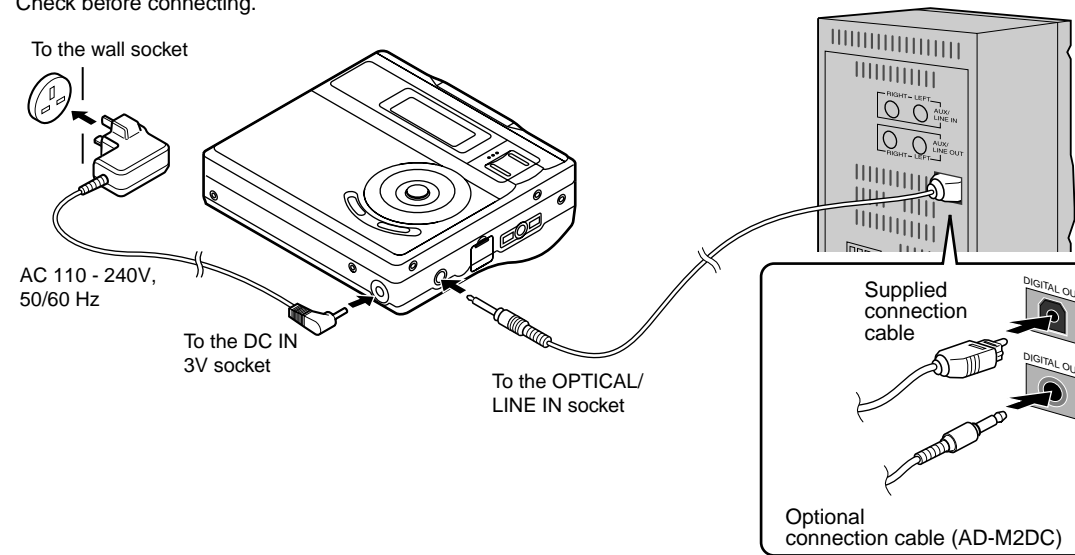

Note:

Some of the above optional accessories may not be available depending on the area.

Hold Function

The operation can be kept even if other buttons are accidentally pressed in a place such as a crowded train.

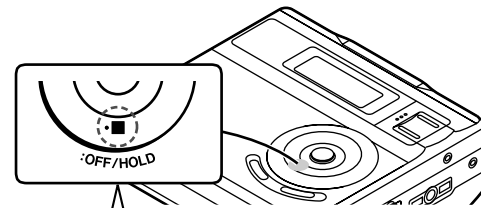

Hold down the HOLD button for 2 seconds or more.

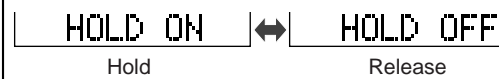

If the battery is inserted or the AC adaptor is connected, you can set this function even when the power is turned off.

To cancel the hold mode

Press and hold down the HOLD button for 2 seconds or more whilst the unit is in the hold mode. "HOLD OFF" will be shown.

Before Recording

IM-DR410E

■ About the TOC

Whilst recording or editing, "TOC" (Table Of Contents) appears. If you stop recording or turn off the power after editing, TOC will be written on the MD ("TOC" will flash followed by "TOC EDIT!"). During the process, the lid is locked and you cannot remove the MiniDisc.

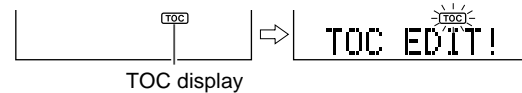

Warning:

If the power is removed (Battery/AC adaptor) whilst "TOC" is displayed, the MiniDisc unit lid will remain locked until the battery/main power is restored and the unit is turned on. Your new recordings or edited changes will be lost and your MiniDisc may become unusable.

Caution:

Whilst "TOC" or "TOC EDIT!" is displayed, follow the instructions below.

- Do not jerk or bump the unit.
- Do not unplug the AC adaptor.
- Do not remove the battery.
- Do not subject the unit to shock.

Otherwise, tracks may not be recorded properly.

■ To prevent recorded MiniDiscs from being erased accidentally

Slide the accidental erase prevention tab, located on the side of the MiniDisc, in the direction indicated by the arrow. The MiniDisc will then be protected against accidental erasure.

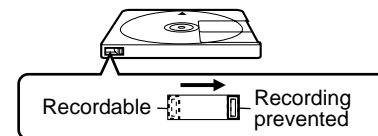

To add a recording to such a MiniDisc, slide the accidental erase prevention tab back to its original position.

■ Helpful tip when attaching a label

When attaching a label to a MiniDisc cartridge, be sure to note the following. If the label is not attached properly, the MiniDisc may jam inside the unit and you may not be able to remove it.

- If the label peels off or partially lifts away, replace it with a new one.
- Do not put a new label on top of an existing one.
- Attach the label only in the specified location.

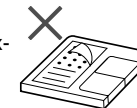

Preparation
-Before Recording-

3

15

Recording

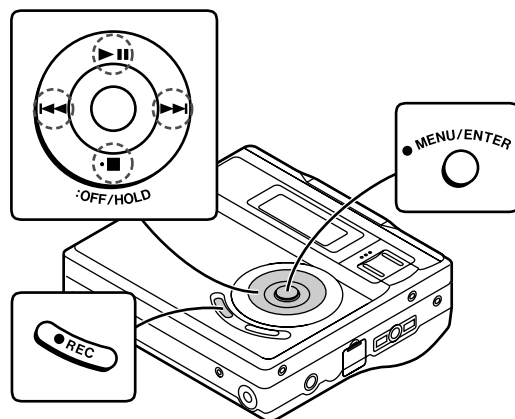

Before recording

Cancel the hold mode.

The portable MD does not work whilst in the hold mode. As for the details, see page 14.

- 1 Press the REC button.**
- 2 Begin playback on the stereo system connected to this portable MD.**

- 3 Press the ◀◀ or ▶▶ button to adjust the recording level.**

Analogue recording (connecting with analogue cable)

Adjust the recording level so that the maximum sound volume from the source makes the reading swing somewhere between -4 dB and 0 dB.

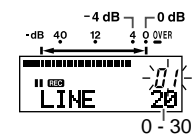

Digital recording (connecting with digital cable)

You can adjust the level in 1 dB increments between + 10 dB and - 10 dB.

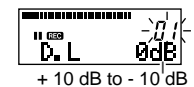

Once you adjust the recording level, the setting is retained even after the recording stops. (For cancellation instructions for the digital recording level, see page 27.)

The sound from the earphones does not change even if the digital recording level is adjusted.

- 4 Press the PAUSE button on the stereo system to enter the playback pause mode.**

Here, you can search for the track to be recorded.

- | | | | | | | | | |
|--|--------------------------|--------------------|-----|--------------------------|-----|--------------------------|------|----------------------|
| 5 Press the MENU/ENTER button. | | | | | | | | |
| 6 Press the ◀◀ or ▶▶ button repeatedly to select "REC MODE". | | | | | | | | |
| 7 Press the MENU/ENTER button. | | | | | | | | |
| 8 Press the ◀◀ or ▶▶ button repeatedly to select the recording mode (page 22). | | | | | | | | |
|  <table> <tr> <td>SP</td> <td>(Stereo recording)</td> </tr> <tr> <td>LP2</td> <td>(2 times long recording)</td> </tr> <tr> <td>LP4</td> <td>(4 times long recording)</td> </tr> <tr> <td>MONO</td> <td>(Monaural recording)</td> </tr> </table> | SP | (Stereo recording) | LP2 | (2 times long recording) | LP4 | (4 times long recording) | MONO | (Monaural recording) |
| SP | (Stereo recording) | | | | | | | |
| LP2 | (2 times long recording) | | | | | | | |
| LP4 | (4 times long recording) | | | | | | | |
| MONO | (Monaural recording) | | | | | | | |
| 9 Press the MENU/ENTER button. | | | | | | | | |
| The mode will be set automatically after 7 seconds even if the MENU/ENTER button is not pressed. | | | | | | | | |
| 10 Press the ▶ button to start the MiniDisc unit recording. | | | | | | | | |
| 11 Begin playback on the stereo system, the output will be recorded. | | | | | | | | |

Notes:

- Complete the operation within 7 seconds whilst selecting the menus.
- Changing the volume level whilst recording does not affect the recording.
- You cannot adjust the bass level whilst recording.
- Whilst "TOC" is displayed, the MiniDisc recorded contents are not yet updated.

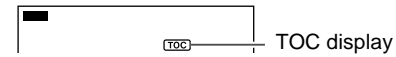
**To interrupt recording**

Press the ▶|| button.

- To resume recording, press the ▶|| button again.
- The track number will be increased by one each time the recording is interrupted.

To stop recording

Press the ■:OFF/HOLD button.

When recording is stopped, TOC is written on the MD. The "TOC" indicator disappears.



Playback

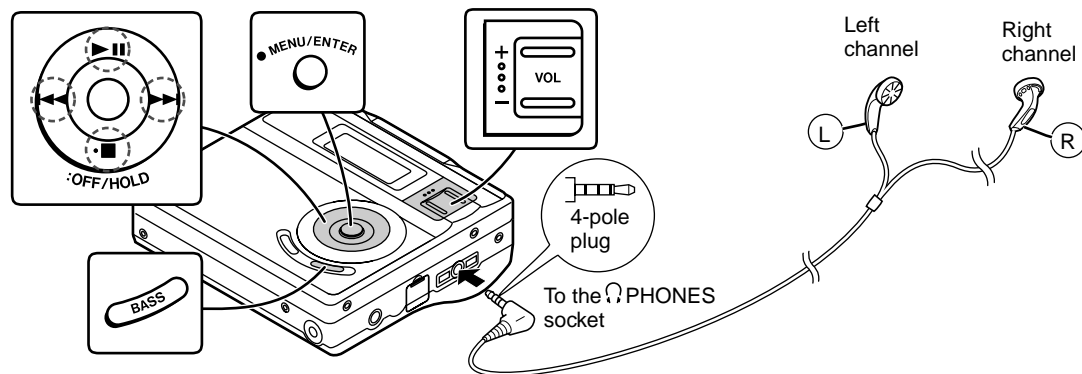

1 Insert the earphones plug into the PHONES socket.

2 Insert a MiniDisc (page 11).

3 Press the ▶|| button.

Playback starts automatically with a playback only MiniDisc or a MiniDisc which is protected against accidental erasure (Auto-play function).



To interrupt playback

Press the ▶|| button.

To resume playback, press the ▶|| button again.

To stop playback

Press the ■:OFF/HOLD button.

The power will turn off automatically after 2 minutes if the unit is left in the stop mode.

To turn off the power

Press the ■:OFF/HOLD button whilst in the stop mode.

■ Volume control

Press the VOL + button to increase the volume and the VOL - button to decrease the volume.

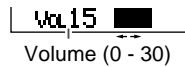

The sound escaping from your earphones may annoy people around you. In particularly crowded places (such as on trains or buses), reduce the volume.

■ Bass control

Each time the BASS button is pressed, the bass response will be switched as follows.

BASS 1	Emphasised slightly.
BASS 2	Emphasised more.
BASS 3	Emphasised fully.
BASS OFF	Cancelled. (Default setting)

■ To customise low and high levels

You can set 3 types of bass settings (BASS 1 - BASS 3) by adjusting low (Lo) and high (Hi) boost for each setting.

Emphasising low (Lo) and high (Hi) sound of BASS 3.

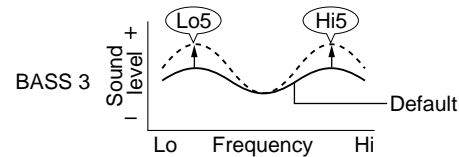

1 During playback, press the MENU/ENTER button.

2 Press the ◀◀ or ▶▶ button repeatedly to select "SOUND ADJ" and then press the MENU/ENTER button.

3 Press the ◀◀ or ▶▶ button repeatedly to select bass setting, and the VOL + or VOL - button to select "B3".



4 After selecting "Lo" or "Hi" with the ◀◀ or ▶▶ button, press the VOL + or VOL - button to adjust the low or high sound setting.



5 Press the MENU/ENTER button.

Repeat steps 1 - 5 to change the other bass setting.

Notes:

- If you set the volume to 23 or more, the bass boost will be adjusted automatically.
- When you make the setting of "To customise low and high levels" with the volume level set to 23 or more, the volume level will be reduced to 22 automatically.

Advanced Playback

■ To locate the desired portion

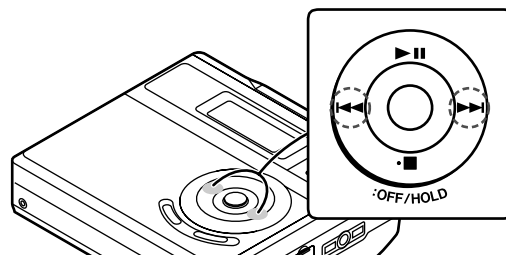

For audible fast forward:

Press and hold down the FF button during playback.

For audible fast reverse:

Press and hold down the RR button during playback.

- Normal playback will resume when the RR or FF button is released.
- When the end of the last track is reached during fast forward, the unit will enter the pause mode. When the beginning of the first track is reached during fast reverse, the unit will enter the playback mode.

■ To locate the beginning of a track

To move to the beginning of the next track:

Press the FF button during playback.

To restart the track being played:

Press the RR button during playback.

To locate the next track:

Press the FF button whilst the unit is stopped.

To locate the previous track:

Press the RR button whilst the unit is stopped.

- To skip a number of tracks at one time, press the RR or FF button repeatedly until the desired track number is shown.
- When you press the FF button, playback starts from the beginning of the track.

■ Random play or repeat play

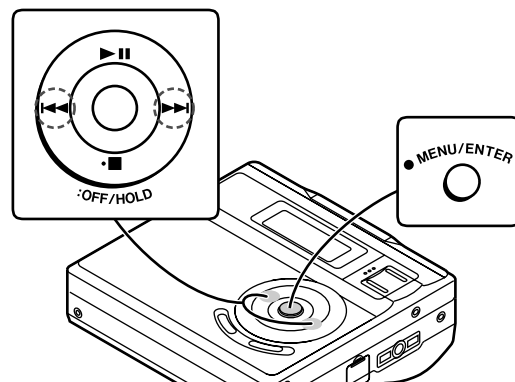

- 1 During playback, press the MENU/ENTER button.
- 2 Press the ◀◀ or ▶▶ button repeatedly to select "PLAY MODE".
- 3 Press the MENU/ENTER button.

PLAY MODE

4 Press the ◀◀ or ▶▶ button repeatedly to select the desired playback mode.

RANDOM : Random play
 RANDOM REP : Repeat play of tracks in random order
 ALL REPEAT : Repeat play of all of the tracks
 1Tr REPEAT : Repeat play of a single track
 NORMAL : Normal playback

5 Press the MENU/ENTER button.

The mode will be set automatically after 7 seconds even if the MENU/ENTER button is not pressed.

Notes:

- Complete the operation within 7 seconds whilst selecting the menus.
- If the playback mode is selected whilst stopped, press the ▶|| button to start playback.
- When "TOC" is displayed, random play or repeat play is impossible.
- In random play, the unit will select and play tracks automatically. (You cannot select the order of the tracks.) After all of the tracks are played once in random order, the unit will stop automatically.
- During random, random repeat, or single track repeat play, you can forward or reverse the MiniDisc only within the track being played.
- During random play, the unit cannot find the beginning of any track which has been played.
- Repeat play lasts until you stop the unit.
- When you stop and resume random play, the rest of tracks are played starting from the last played track. If you turn the power off and resume random play, all the tracks are played in random order starting from the interrupted track.

Advanced Recording

■ Long-play recording

2 times and 4 times long recording

Double or quadruple time of stereo recording is possible.

Monaural recording

In monaural, you can record twice as long as the stereo recording.

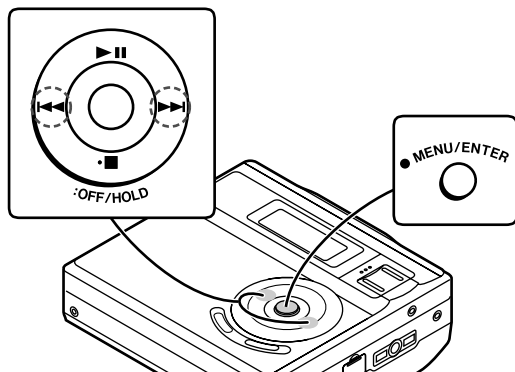

- 1** When recording is paused, press the MENU/ENTER button.
- 2** Press the ◀◀ or ▶▶ button repeatedly to select "REC MODE".
- 3** Press the MENU/ENTER button.

- 4** Press the ◀◀ or ▶▶ button repeatedly to select the desired recording mode.

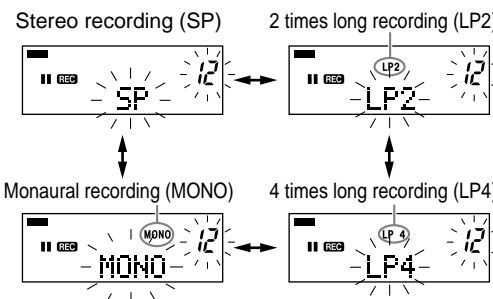

- 5** Press the MENU/ENTER button.

The mode will be set automatically after 7 seconds even if the MENU/ENTER button is not pressed.

- 6** Start recording.

Notes:

- Complete the operation within 7 seconds whilst selecting the menus.
- The recording mode remains unchanged until a new mode is selected.

Notes:

- In monaural recording, the sound on the right and left channels is mixed even if the input source is in stereo. Although you can hear the stereo sound from the earphones, the recorded sound is monaural.
- **Tracks recorded in 2 times long recording and 4 times long recording modes cannot be played with the unit that does not support these modes. On such a unit, no sound is heard. (The operation may vary depending on the unit.)**
- Tracks recorded in monaural cannot be played on a unit that does not support monaural playback.

■ About ATRAC

The ATRAC (Adaptive TRansform Acoustic Coding) system compresses the sound data into 1/5 by cutting out the inaudible sound. Since the sound is selected based on psychoacoustics masking, the sound quality is not impaired. This unit is equipped with the ATRAC3 compressing system that can reduce the sound data to 1/10 or 1/20 of its original size. By employing this system, 2 times and 4 times long recordings are enabled in stereo mode.

■ About the recording mode

You can select the recording mode from stereo recording, 2 times long recording, 4 times long recording, and monaural recording. Recordable time varies depending on the recording mode. If the tracks are recorded on an 80-minute MiniDisc, its recording time changes as follows:

Indication	Recording mode	Recording time
SP	Stereo	MAX. 80 min.
LP2	2 times long (MDLP stereo)	MAX. 160 min.
LP4	4 times long (MDLP stereo)	MAX. 320 min.
MONO	Monaural	MAX. 160 min.

■ Caution for 4 times long recording (LP4)

Special compression methods are used to achieve 4 times long recording. This may cause some noise to be recorded occasionally. When the highest quality is required, stereo or LP2 recording is recommended.

Advanced Recording (continued)

■ Playback sound-actuated recording

Recording automatically starts or pauses by detecting sound from the stereo system (synchronised recording).

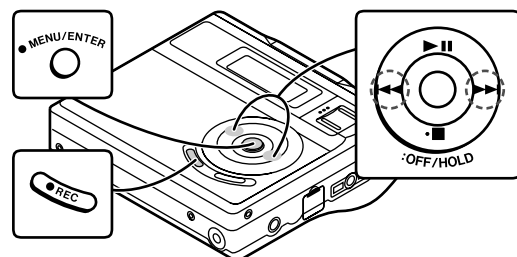

- 1** Press the REC button.
- 2** Begin playback on the stereo system connected to this portable MD.
- 3** Press the ◀◀ or ▶▶ button to adjust the recording level (see page 16).
- 4** Press the PAUSE button on the stereo system to enter the playback pause mode. Select the starting point for your recording and press the PAUSE button.
- 5** Press the MENU/ENTER button.
- 6** Press the ◀◀ or ▶▶ button repeatedly to select "REC MODE".

- 7** Press the MENU/ENTER button.

- 8** Select the recording mode (step 4, page 22) and press the MENU/ENTER button.

The mode will be set automatically after 7 seconds even if the MENU/ENTER button is not pressed.

- 9** Press the MENU/ENTER button.

- 10** Press the ◀◀ or ▶▶ button repeatedly to select "SYNC ON".

- 11** Press the MENU/ENTER button.

- The BASS/SYNC button can be used instead of steps 9 - 11.
- "SYNC" will flash.
- To cancel the operation, press the ■:OFF/HOLD button.

- 12** Begin playback on the stereo system.

Recording will begin automatically.

To interrupt recording

- When the stereo system is stopped, the unit will enter the synchro recording pause mode. When playback is resumed, recording will also resume.
- If a silence lasts for 3 seconds or more, recording will be paused (pause function does not work for approximately 10 seconds after recording starts). When the unit receives sound again, recording automatically starts.
- A new track number is created when recording resumes.

■ To create your own track numbers

You can create your own track numbers at any point.

Whilst recording, press the REC button at the point where you want to create track numbers.

The track number will be increased by one. One track number will be added every time the REC button is pressed.

Numbering restriction

If you try to number more than 10 tracks in certain amount of time, "SORRY" will be displayed and the operation will be disabled.

In that case, wait until the next operation can be resumed.

In stereo recording	Within 40 seconds
In 2 times long recording	Within 80 seconds
In 4 times long recording	Within 160 seconds
In monaural recording	Within 80 seconds

■ Recording tracks as a single track

You can record several pieces of music as a single track by disabling the auto marker function.

When recording is paused or whilst recording...

- 1 Press the MENU/ENTER button.**
- 2 Press the ◀◀ or ▶▶ button repeatedly to select "MARK".**
- 3 Press the MENU/ENTER button.**
- 4 Press the ◀◀ or ▶▶ button to select "MARK OFF".**

⊠AUTO MARK⊠ ⇄ ⊠MARK OFF⊠

- 5 Press the MENU/ENTER button.**

Notes:

- Complete the operation within 7 seconds whilst selecting the menus.
- When making digital recordings using a CD player or an MiniDisc player, track numbers will be created automatically regardless of the setting of the auto marker function.

Advanced Recording (continued)

■ About track numbers

- Track numbers are created automatically during recording via the analogue connection when a silence of 1 second or more is detected (auto marker function). A series of tracks can be recorded as one by disabling the auto marker function (see page 25).

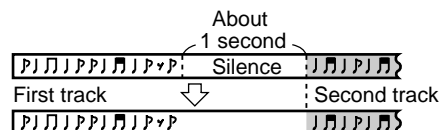

- When recording from a CD or a MiniDisc using the digital connection, track numbers will be created at the same points as on the CD or MiniDisc (synchro marker function).

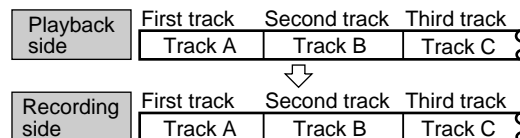

- Track numbers may not be created in proper places, depending on the source to be recorded from, such as signals with noise.
- The track numbers on the playback side may not match the track numbers recorded on the MiniDisc.

- When recording, if a programmed playback is performed by the source or playback is performed by selecting tracks manually, the MiniDisc track numbers may not be the same as on the source.
- Track numbers may not be created properly, depending on the connected stereo system.

■ About sampling rate converter

This portable MD incorporates a sampling rate converter so that it can record from digital radios or DAT tape recorders.

■ Note for digital recording

You cannot copy a MiniDisc that you recorded from digital inputs to another MiniDisc or DAT. It is prevented by the SCMS (Serial Copy Management System). Recording from analogue inputs is not affected.

Digital signals Digitally recorded MiniDisc Cannot record

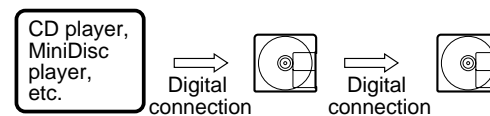

Changing Default Settings

IM-DR410E

Whilst in the stop mode ...

- 1 With a MiniDisc inserted, press the MENU/ENTER button for 2 seconds or more. "SET UP" will appear.**
When you release the button, "BEEP" will flash.
- 2 Press the ◀◀ or ▶▶ button to select the menu.**
- 3 Press the MENU/ENTER button to display the setting item.**
- 4 Press the ◀◀ or ▶▶ button to select the setting items.**
- 5 Press the MENU/ENTER button.**

MENU	SETTING ITEM
BEEP (Confirmation sound)	BEEP ON* Beep
	BEEP OFF Silent
AUTO PLAY (Auto play)	A-PLAY ON* Set.
	A-PLAY OFF Cancelled.
POWER SAVE (Auto power save)	AUTO Psave* Set.
	Psave OFF Cancelled.
D-LEVEL (Digital recording level)	D.L MODE 1* Setting retained.
	D.L MODE 2 Cancelled.

(*) indicates default setting.

■ Beep sound

You can eliminate the confirmation sound that beeps when you press a button.

■ Auto play

You can make the unit not play automatically when you insert a playback-only MiniDisc or an accidental erasure protected MiniDisc.

■ Auto power save

When the unit is used in a place exposed to much vibration, sound skipping can be decreased by cancelling the auto power save function. (Battery will drain faster.)

What is auto power save function?

During playback, maximum 40 seconds (in stereo) of musical information is stored. Auto power save function automatically adjusts the storage time between 5 and 40 seconds to reduce the power consumption. If this function is cancelled, the storage time cannot be adjusted.

- If this unit is used with the AC adaptor, the storage time will be 40 seconds regardless of the settings.
- The storage time varies depending on the recording mode.

■ Digital recording level

"D.L MODE 1"

The digital recording level you set will be kept even after cancelling recording.

"D.L MODE 2"

Every time you cancel recording, the level will return to [D.L 0dB].

Checking Displays

- To check the elapsed time and remaining time of the track
- 1 During playback, press the MENU/ENTER button.
 - 2 Press the ◀◀ or ▶▶ button repeatedly to select "DISPLAY".
 - 3 Press the MENU/ENTER button.
 - 4 Press the ◀◀ or ▶▶ button.

Each time the ◀◀ or ▶▶ button is pressed, the display will change as follows.

- Ⓐ Track name
- Ⓑ Elapsed playback time
- Ⓒ Remaining playback time

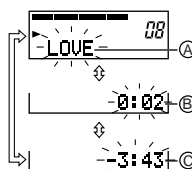

Notes:

- If the disc name or the track name was not originally recorded on the MiniDisc, "NO NAME" will be displayed.
- Elapsed playback time and remaining playback time may be different from the actual time.
- The selected display will not change even after the disc is replaced.

- To check the remaining recording time and the total playing time

- 1 Whilst in the stop mode, press the MENU/ENTER button.
- 2 Press the ◀◀ or ▶▶ button repeatedly to select "DISPLAY".
- 3 Press the MENU/ENTER button.
- 4 Press the ◀◀ or ▶▶ button.

Each time the ◀◀ or ▶▶ button is pressed, the display will change as follows.

- Ⓐ Disc name
- Ⓑ Remaining recording time
- Ⓒ Total playing time



Notes:

- Remaining recording time varies depending on the set recording mode.
- Remaining recording time will not be displayed with a playback only MiniDisc.

- To display the playing time of an individual track

- 1 Whilst in the stop mode, press the ◀◀ or ▶▶ button to display the track number and track name.

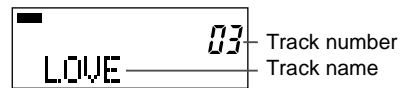

- 2 Press the MENU/ENTER button.
- 3 Press the ◀◀ or ▶▶ button repeatedly to select "DISPLAY".
- 4 Press the MENU/ENTER button.
- 5 Press the ◀◀ or ▶▶ button to select the playing time.



- 6 Press the MENU/ENTER button.

- Checking the remaining amount of battery level

The remaining amount of battery level is shown by the battery indicator () during operation.

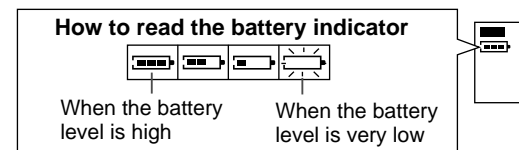

- When the battery level is very low, the battery indicator will flash. Replace the alkaline battery with a new one.
- When the battery has run out completely, "BATT EMPTY" will appear. Then, the power will be disconnected automatically.

Notes:

- The battery indicator will not correctly display the remaining capacity for approximately 10 seconds after the power has been turned on.
- When the AC adaptor is used, the battery indicator will not be shown.
- The number of bars shown in the battery indicator may increase or decrease, depending on the operation being performed. This is normal.

Titling a MiniDisc

■ Creating disc and track names

Load a MiniDisc to be named. A playback only or recording prevented MiniDisc cannot be edited.

- 1

<Disc name>	<Track name>
Whilst in the stop mode, press the MENU/ENTER button.	Whilst in the pause mode, press the MENU/ENTER button.
- 2 Press the ◀◀ or ▶▶ button repeatedly to select "EDIT".
- 3 Press the MENU/ENTER button.
- 4

<Disc name>	<Track name>
Press the ◀◀ or ▶▶ button repeatedly to select "DISC NAME".	Press the ◀◀ or ▶▶ button repeatedly to select "TRACK NAME".

DISC NAME TRACK NAME

- 5 Press the MENU/ENTER button.

Cursor

Cursor

- The unit will enter the character input mode.
- To cancel the operation, press the ■/OFF/HOLD button.

- 6 Press the ▶|| button repeatedly to select the type of characters.

select ABC

ABC abc 123
(Capital letters) (Lower-case letters) (Numbers and symbols)

The first 3 characters in the group of the selected characters will be displayed for about 1 second.

- 7 Press the ◀◀ or ▶▶ button repeatedly to select the letter.

◀LAB → ◀ABC

- 8 Press the MENU/ENTER button to enter it.

B ◀ABC

Position where the next letter will be entered

Note:

Complete the operation within 7 seconds whilst selecting the menus.

- 9** To enter more letters, repeat steps 6 - 8.
- 10** When the name is completely entered, press and hold down the MENU/ENTER button for 2 seconds or more.
- "TOC" will be displayed. To write the updated contents to the MiniDisc, press the ■:OFF/HOLD button.
 - You cannot remove the MiniDisc whilst "TOC" is displayed. "TOC" will not disappear until the recorded contents have been updated.

■ Characters (symbols)

Capital letters	
␣	A B C D E F G H I J K L M N O P Q R
␣	S T U V W X Y Z [] ^ _ / `
Lower-case letters	
␣	a b c d e f g h i j k l m n o p q r
␣	s t u v w x y z [] ^ _ / `
Numbers and symbols	
␣	1 2 3 4 5 6 7 8 9 0 ! " # \$ % & ' (
␣) * + , - . / : ; < = > ? @ _ ` []

␣ (Delete) : erases a character.
 [] (Space) : indicates a space.

■ To erase a character

Press the VOL + or VOL - button to move the cursor to the character you want to erase, and then press the BASS button. You can also erase a character by selecting "DL" and pressing the MENU/ENTER button.

■ To enter a space

Press the VOL + button to move the cursor to the right.

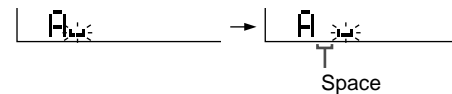

Notes:

- One disc name and up to 255 track names can be created per disc (a maximum of 40 characters for the disc and each track name and a total of about 1,700 characters can be entered).
- If you enter "LP:" at the beginning of a name, "LP:" may not be displayed.

Titling a MiniDisc (continued)

■ To add characters

- 1 Put the unit in the character input mode.**
(Perform steps 1 - 5 on page 30.)
- 2 Press the VOL + or VOL - button to move the cursor to the character before which you want to add a new character.**

| BST *LAB |

- 3 Select the character to add.**
(Perform steps 6 - 8 on page 30.)
- 4 Press and hold down the MENU/ENTER button for 2 seconds or more.**
 - "TOC" will be displayed. To write the updated contents to the MiniDisc, press the ■:OFF/HOLD button.
 - You cannot remove the MiniDisc whilst "TOC" is displayed. "TOC" will not disappear until the recorded contents have been updated.

■ Stamping titles from another MiniDisc

Before stamping

When there are 2 MiniDiscs on which the same tracks are recorded, you can transfer the character information (disc and track names) of the master MiniDisc to another MiniDisc (for stamping).

1. What is a master MiniDisc?

A recordable MiniDisc that contains tracks and character information. (You cannot transfer the information from a playback-only MiniDisc.)

2. What is a MiniDisc for stamping?

A MiniDisc that contains the same tracks in the same order as the master MiniDisc. (Make sure that the total number of tracks of the master MiniDisc and the one for stamping are the same.)

Master MiniDisc operation**1 Insert a master MiniDisc.**

Do not mistake the master MiniDisc for the target one.

2 Whilst in the stop mode, press the MENU/ENTER button.**3 Press the ◀◀ or ▶▶ button repeatedly to select "EDIT".****4 Press the MENU/ENTER button.****5 Press the ◀◀ or ▶▶ button repeatedly to select "NAME STAMP".**

```
NAME STAMP
```

6 Press the MENU/ENTER button.

```
READ OK?
```

To cancel the operation, press the ■:OFF/HOLD button.

7 Press the MENU/ENTER button.

```
Reading! | CHANGE MD
```

8 When the unit displays "CHANGE MD", remove the master MiniDisc.

Remove it without turning off the power. Or, the operation will be cancelled.

```
INSERT MD
```

Operation of the MiniDisc for stamping**9 Load a MiniDisc for stamping.**

```
TOC READ | WRITE OK?
```

10 Press the MENU/ENTER button.

```
Writing! | COMPLETE
```

The unit will finish recording the character information and enter the stop mode.

Note:

If the total number of tracks on the master MiniDisc does not match that on the MiniDisc for stamping, the unit will display "Can'tSTAMP" and turn off.

```
Can'tSTAMP
```

If this happens, adjust the total number of tracks on the newly recorded MiniDisc using the edit operation.

Editing a Recorded MiniDisc

■ To erase one track at a time

- 1 Start playing the track to be erased, and press the ►|| button.
- 2 Press the MENU/ENTER button.
- 3 Press the ◀◀ or ▶▶ button repeatedly to select "EDIT".
- 4 Press the MENU/ENTER button.
- 5 Press the ◀◀ or ▶▶ button repeatedly to select "ERASE".

ERASE 03

- 6 Press the MENU/ENTER button.

ERASE 03?

To cancel the operation, press the ■:OFF/HOLD button.

- 7 Press the MENU/ENTER button again.

The track will be erased.

- 8 To erase other tracks, repeat steps 1 - 7.

Note:

Complete the operation within 7 seconds whilst selecting the menus.

■ To erase all of the tracks at once

- 1 Whilst in the stop mode, press the MENU/ENTER button.
- 2 Press the ◀◀ or ▶▶ button repeatedly to select "EDIT".
- 3 Press the MENU/ENTER button.
- 4 Press the ◀◀ or ▶▶ button repeatedly to select "ALL ERASE".

ALL ERASE

- 5 Press the MENU/ENTER button.

ERASE OK?

To cancel the operation, press the ■:OFF/HOLD button.

- 6 Press the MENU/ENTER button again.

BLANK MD

All of the tracks will be erased.

Caution:

Once a track has been erased, it cannot be recovered. Check the track number before erasing it.

■ To divide a track

- 1 Start playing the track to be divided into two. Press the ►|| button at the point where you want to divide the track.
- 2 Press the MENU/ENTER button.
- 3 Press the ◀◀ or ▶▶ button repeatedly to select "EDIT".
- 4 Press the MENU/ENTER button.
- 5 Press the ◀◀ or ▶▶ button repeatedly to select "DIVIDE".

◀ DIVIDE ▶

- 6 Press the MENU/ENTER button.

◀ DIVIDE OK? ▶

To cancel the operation, press the ■:OFF/HOLD button.

- 7 Press the MENU/ENTER button again.

The track will be divided into two tracks, and the unit will be paused at the beginning of the second of the two new tracks.

■ To combine tracks

- 1 Start playing the latter of the two tracks to be combined, and press the ►|| button.
- 2 Press the MENU/ENTER button.
- 3 Press the ◀◀ or ▶▶ button repeatedly to select "EDIT".
- 4 Press the MENU/ENTER button.
- 5 Press the ◀◀ or ▶▶ button repeatedly to select "COMBINE".

◀ COMBINE ▶

- 6 Press the MENU/ENTER button.

◀ 05+ 06 ? ▶

To cancel the operation, press the ■:OFF/HOLD button.

- 7 Press the MENU/ENTER button again.

The two tracks will be combined, and the unit will be paused at the beginning of the combined track.

Editing a Recorded MiniDisc (continued)

■ To move a track

- 1 Play the track to be moved, and press the ►|| button.
- 2 Press the MENU/ENTER button.
- 3 Press the ◀◀ or ▶▶ button repeatedly to select "EDIT".
- 4 Press the MENU/ENTER button.
- 5 Press the ◀◀ or ▶▶ button repeatedly to select "MOVE".

◀ MOVE ▶

- 6 Press the MENU/ENTER button.

05→ 01 ?

To cancel the operation, press the ■:OFF/HOLD button.

- 7 Press the ◀◀ or ▶▶ button to select the direction.

05→ 03 ?

- 8 Press the MENU/ENTER button again.

The track will be moved, and the unit will be paused at the beginning of the track.

When a track has a name before dividing:

The two new tracks will have the same name. However, in the "TOC FULL" condition, the second track may not be named.

Total number of tracks that can be divided:

Each disc can hold up to 255 tracks. However, even if the number of assigned tracks has not reached 255, it might not be possible to make any further divisions of tracks.

To combine two non-adjacent tracks:

First, put the two tracks next to each other in the order you want using the MOVE function. Then combine them using the COMBINE function.

When one or both tracks to be combined have a name:

The first track name will be used. However, when the first track does not have a name, the second track name will be used.

In the following cases, tracks may not be combined.

- Tracks recorded by different input modes/sources cannot be combined.
- Examples:
 - Digital recorded track and analogue recorded track.
 - Different recording modes (stereo recording, 2 times long recording, 4 times long recording, monaural recording).
 - Tracks whose recording time is less than 12 seconds.

Listening through Another System

When connecting with other equipment, turn off the power or turn down the volume to "0".

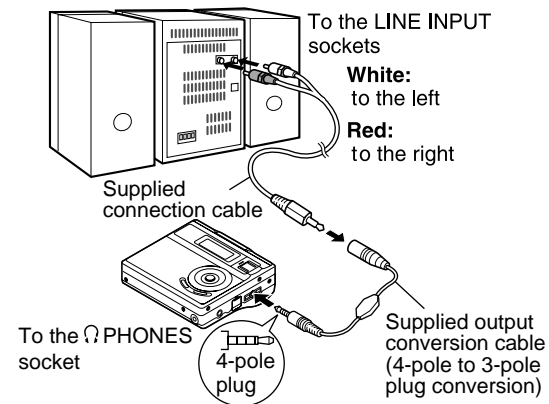

Notes:

- It is recommended that the volume level of the MiniDisc unit be set to maximum when listening through a stereo system.
- When recording with a stereo system, eliminate the confirmation sound (page 27). Otherwise, it will also be recorded.
- Recording will be made in the analogue mode.
- Character information will not be recorded.

Resuming auto play

IM-DR410E

When you stop and then restart playback without removing the disc, playback will resume from the point at which the disc was stopped.

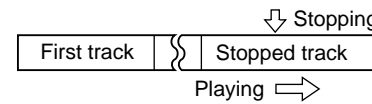

Once you remove the MiniDisc, playback starts from the first track.

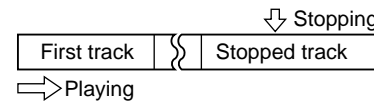

If you unplug and plug in the AC adaptor without a battery in the unit, playback starts from the beginning of the stopped track.

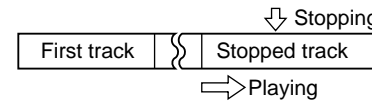

Advanced Features
-Listening through Another System/Resuming auto play-

About Net MD

■ What is a Net MD portable recorder?

The USB is adopted to ensure high compatibility of PCs and MDs.

Audio data saved on the hard disk of a PC can be transferred to a Net MD-compatible recorder using the provided software "BeatJam".

Not only the basic operations but also the title editing of audio data on an MD can be performed via the PC.

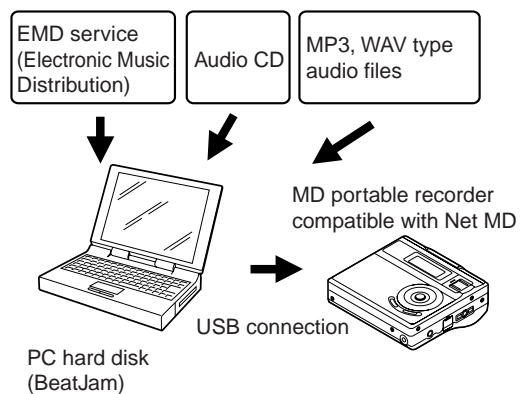

Digital audio data can be imported into the hard disk of a PC in the following methods:

- Converting the music downloaded via the music distribution service on the Internet into ATRAC3 of the OpenMG system.
- Recording an audio CD via the CD-ROM drive of a PC on the hard disk. (Compressing data with the ATRAC3 sound compressing system)
- Converting the existing MP3, WAV audio files into ATRAC3 of the OpenMG system.

The saved audio data can be played on the existing MD player, as its recording method is not changed when being recorded on an MD. (To play audio data saved in the MDLP mode, the MDLP-support MD player is required.)

All the audio data managed by "BeatJam" is encrypted by the OpenMG system and recorded on the hard disk of the PC, which prevents its unauthorised use or distribution.

■ Transferring audio data from a PC to MD portable recorder IM-DR410E (check-in/check-out)

By using the provided software "BeatJam", you can transfer audio data from the hard disk of the PC to IM-DR410E, the Net MD-support MD portable recorder.

"Check-out" is to transfer audio data from a PC to a Net MD-support MD portable recorder, and "check-in" is to return it from the recorder to the same PC.

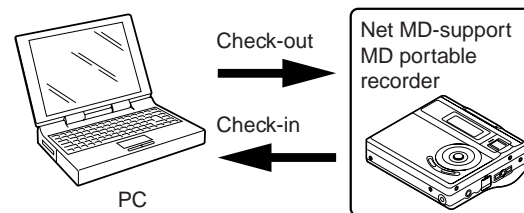

■ Restrictions on check-in and check-out

- One piece of audio data can be checked out up to 3 times (except for some pieces).
You cannot check out a track more than 3 times. However, if the track is returned to the PC once by using the check-in function, you can check out the same track again.
- You can check in the checked-out audio data to the same PC only. You cannot check it in to other PCs.

■ Restrictions on audio data

Along with the popularization of the music distribution service via the Internet, high-quality digital music can be obtained easily, whereas some pieces are distributed with restrictions on the number of check-out or the recording/playback method to prevent infringement of copyrights caused by unauthorised distributions. This unit mounts the copyright protection technology to realise playback or recording in compliance with the will of the copyright owners. For details in possibilities and the frequency of audio data check-out to a Net MD-support device, contact respective music distribution service companies.

System Requirements

See the table below for the system requirements, especially free space and memory.

OS	Windows® XP Home Edition*1/ Professional*1	Windows® Mil- lennium Edition	Windows® 98 Second Edition	Windows® 2000 Professional*1
CPU	Pentium® II 300 MHz or higher (MMX® Pentium® 233 MHz minimum)	MMX® Pentium® 233 MHz or higher (MMX® Pentium® 200 MHz minimum)		MMX® Pentium® 233 MHz or higher (MMX® Pentium® 200 MHz minimum)
Memory	128 MB or more (64 MB minimum)	64 MB or more		64 MB or more
Others	<ul style="list-style-type: none"> ● Display...1024 x 768 resolution, High Color or upper ● Sound source...Sound card 			

*1 To use this software, login as system administrator (computer administrator).

Hard disk space 120 MB or more

- Additional space is required to store music data.
- The required space depends on the format or reserved space.

Notes:

- USB ports are required to connect with external devices or media. The operation via USB hub is not guaranteed.
- Depending on the driver or CD-ROM drive, audio CDs may not be recorded.
- Operations are not guaranteed when using BeatJam
 - on dual-boot computers.
 - with other music software simultaneously.
 - with different version simultaneously.
- You cannot use BeatJam with programs that create virtual CD-ROM drives.
- You cannot use BeatJam when more than one OpenMG compatible audio device is connected.

- "BeatJam" is a copy protected material of Justsystem Corporation. Copyrights and other rights related to "BeatJam" belong to Justsystem Corporation.
- "BeatJam" is a registered trademark of Justsystem Corporation.
- "ATRAC3" and its logo, "OpenMG" and **OpenMG**, "Net MD" and **(NEEMD)**, OpenMG Jukebox and Sonic-Stage are trademarks of Sony Corporation.
- Pentium and MMX are registered trademarks of Intel Corporation in the United States.
- Microsoft, Windows, and DirectX are trademarks or registered trademarks of Microsoft Corporation in the United States and/or other countries.
- Screen shots are used according to the guide lines of Microsoft Corporation.
- "ATRAC3" and its logo indicate audio compression technology of Sony Corporation. The compatibility is not guaranteed.
- Other company names and product names are trademarks or registered trademarks of their respective owners or Justsystem Corporation.

Software Installation

IM-DR410E

■ Installation of BeatJam

Plugin and USB driver required for transferring music files are also installed along with BeatJam.
(Example: Windows® XP English version)

1 Insert BeatJam CD-ROM into the CD-ROM drive.

Setup application appears.



2 Click "BeatJam Setup".

Setup starts.

Follow the instructions on the screen.

Installation does not start even if CD-ROM is inserted
If the setup application does not appear, perform the following.

1. Click Windows "Start" button and select "My Computer". Double click "My Computer" on the desktop if you use Windows® Me, 98SE or 2000.
2. Right click on "OMGBJ" indicating CD-ROM drive and select "Open" from the menu.
3. Double click AUTOPLAY.EXE from the list.

Caution:

Windows® XP/2000

User with Administrator* rights needs to log on. Confirm with the network or computer Administrator if you are in a workgroup.

* User name in Administrator or Administrators group under Windows® 2000.

For Windows® XP and Me user

When you use the "System Restore" system tool in Windows® XP or Windows®Me, all the music files that you recorded or imported may become unplayable. Please back up all your music files using the Backup Tool before executing "System Restore".

If a previous version of OpenMG Jukebox* or SonicStage* is currently installed on your computer

OpenMG Jukebox or SonicStage should be upgraded. The screen appears to prompt you to upgrade the software. Click "Continue" to proceed.

* OpenMG Jukebox and SonicStage are softwares of Sony Corporation.

Hard disk contains old BeatJam database

You can select to reuse or delete the database during setup.

Connecting to a PC

Connect your PC and the MD portable recorder with the supplied USB connection cable.

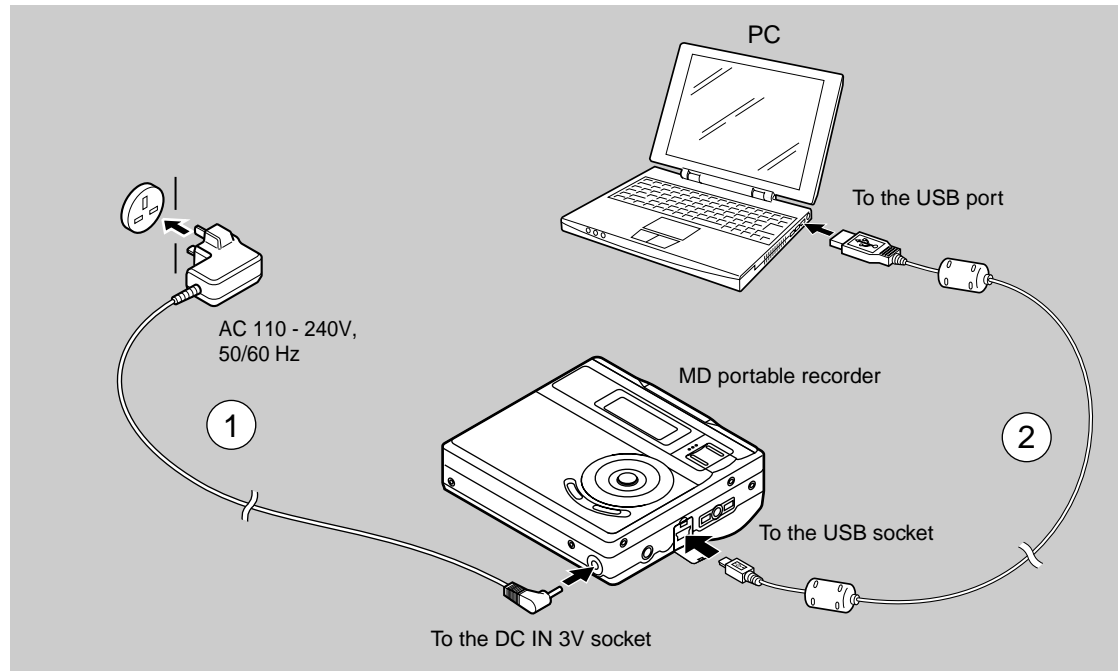

Net MD
-Connecting to a PC-

Caution:

- The operation is not guaranteed if 2 or more USB devices are connected to your PC.
- Insert the USB connection cable directly into the USB port on the PC. We do not guarantee the operation with it connected via a USB hub, etc.
- When connecting the MD portable recorder, disconnect all the other USB devices from the PC. The sound may skip if they are connected.
- **It is recommended that the MD portable recorder be used with an AC adaptor.**
- If the power supply to the PC or the MD portable recorder stops during the operation of this system, TOC information may not be written on the MD. If it occurs, restart the operation from the beginning.
- We do not guarantee the operation with the self built computers or modified motherboards.
- If cables such as an extension cable or two-way cable is connected instead of a connection cable, the line quality will be degraded and the software may not operate properly.
- When connecting the unit to your PC, use a battery as well as an AC adaptor. It not only prevents data loss from disconnection, but also speeds up data writing to MD.

■ Checking the USB driver

Whilst the MD portable recorder is connected to the computer, after clicking "Control Panel" → "System", select the "Hardware" tab and click "Device Manager" to check the following device name.

- **Universal Serial Bus controllers**

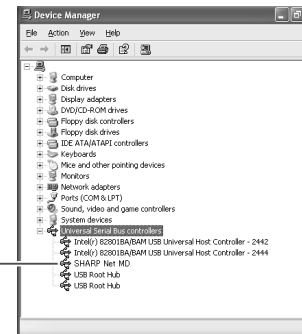

Net MD

Windows® 2000:

Open "System" in "Control Panel", select the "Hardware" tab and click "Device Manager".

Windows® 98 Second Edition:

Open "System" in "Control Panel", and click the "Device Manager".

Transferring Data

■ Checking out

Check-out is to transfer tracks to OpenMG compatible players. You can check out recorded tracks with BeatJam up to 3 times.

1 Connect this unit to the PC.

"PC" appears on the unit display and operations with the unit are disabled.

However, "PC" is not displayed whilst in the recording, recording pause or menu operation mode.

2 Transfer music files to the unit (check-out).

For details, refer to the manual of BeatJam.

Follow the instructions below to take out the MD after check-out:

1. Remove the USB connector from the MD portable recorder.
2. Turn off the MD recorder.
3. Remove the MD.

■ Checking in

Check-in means to return the tracks from external devices to the PC. You can check-in tracks only to the source PC.

1 Connect this unit to the PC.

"PC" appears on the unit display and operations with the unit are disabled.

However, "PC" is not displayed whilst in the recording, recording pause or menu operation mode.

2 Return a music file to your PC.

For details, refer to the manual of BeatJam.

Caution:

- If the USB connection or the power supply to the computer or the MD portable recorder is cut off during check-in or check-out operation, audio data may be lost.
- If a checked-out track is deleted in another computer, it cannot be checked in any more.

TOC writing on an MD:

- TOC writing will start when check-in or check-out is complete. Whilst writing, TOC indicator on the unit will flash. (Refer to page 15.)

MiniDisc System Limitations

IM-DR410E

The unit may have the following symptoms whilst recording or editing. The unit is not out of order.

SYMPTOM	LIMITATIONS
"DISC FULL" or "TOC FULL" appears even though the MiniDisc still has recording time left.	More than 255 tracks (maximum) cannot be recorded regardless of the recording time. If the MiniDisc is recorded or edited repeatedly or if it has scratches (recording skips scratched parts), you may not be able to record the maximum tracks above.
The remaining recording time does not increase even though you erased tracks.	The unit does not count non-recorded portions that last 12 or fewer seconds to display the remaining recording time. The time may not increase even if you erase short tracks.
The total of the recorded time and the remaining time does not match the maximum recordable time.	One cluster (approximately 2 seconds) is the minimum unit for recording. For example, a 3-second track uses 2 clusters (approximately 4 seconds). Therefore, the actual recordable time may be shorter than the displayed time.
Combine function does not work.	A MiniDisc on which recording and editing are repeated may not allow the combine function.
Sound skips in fast reverse/forward.	If one track is divided and recorded in separate places on a repeatedly recorded or edited MiniDisc, sound may skip.
A track number is created in the middle of a track.	A track number may be created if there are scratches or dust on the MiniDisc.

Error Messages

ERROR MESSAGES	MEANING
BATT EMPTY	<ul style="list-style-type: none"> The battery has run down.
BLANK MD	<ul style="list-style-type: none"> Nothing is recorded. (Replace the disc with a recorded disc.)
Can't COPY	<ul style="list-style-type: none"> You tried to record from a copy prohibited MiniDisc. (Record using the analogue cable.) You tried to record signals other than music (such as data).
Can't EDIT	<ul style="list-style-type: none"> A track cannot be edited. (Change the stop position of the track and then edit it.)
Can't LOCK	<ul style="list-style-type: none"> You tried to remove the MD whilst recording or editing.
Can't PLAY	<ul style="list-style-type: none"> You tried to play back a track that cannot be played with this equipment.
Can't READ (*)	<ul style="list-style-type: none"> The disc data cannot be read because the disc is damaged. (Reload the Minidisc or replace it with another one.)
Can't REC	<ul style="list-style-type: none"> Recording cannot be performed correctly due to vibration or shock.

ERROR MESSAGES	MEANING
Can't STAMP	<ul style="list-style-type: none"> Stamp function does not work. (Check the number of tracks.)
Can't WRITE	<ul style="list-style-type: none"> Cannot save the TOC information correctly to a MiniDisc.
DEFECT!	<ul style="list-style-type: none"> The disc is scratched. (If the recorded sound is not right, retry recording or replace the disc with a recordable one.)
DISC FULL	<ul style="list-style-type: none"> The disc is out of recording space.
Er-MD (**)	<ul style="list-style-type: none"> The microprocessor has reported a system fault and the unit is out of order. (To have it repaired, go to the distributor where you purchased the unit.)
HOLD	<ul style="list-style-type: none"> The unit is in the hold mode.
LOCKED	<ul style="list-style-type: none"> You removed a MiniDisc whilst recording or editing. (Turn off the power before removing the MiniDisc.)
NO DISC	<ul style="list-style-type: none"> A disc has not been loaded.

A number or symbol appears in (*) position.

ERROR MESSAGES	MEANING
NO SIGNAL	<ul style="list-style-type: none"> Poor connection of the digital cable. No output signal comes out from the connected unit. (Use the AC power for the connected unit.) <ul style="list-style-type: none"> The input signal has improper sampling frequency.
PLAY MD	<ul style="list-style-type: none"> You tried to record on a playback-only disc.
POWER?	<ul style="list-style-type: none"> AC adaptor other than specified.
PROTECTED	<ul style="list-style-type: none"> The write protection tab of a MiniDisc is set to the protected position.
SORRY	<ul style="list-style-type: none"> Since a track number is currently being located or updated, the unit cannot accept your command. (Wait a while and try the operation again.)

ERROR MESSAGES	MEANING
TEMP OVER	<ul style="list-style-type: none"> The temperature is too high. (Turn off the power, and wait a while.)
TOC FORM (**)	<ul style="list-style-type: none"> There is an error in the recording signal. (Erase all of the tracks, and then record again.)
TOC FULL	<ul style="list-style-type: none"> There is no space left for recording character information (track names, disc names, etc.).
Tr. Protect	<ul style="list-style-type: none"> The track has been protected from being erased. (Edit the track with the device on which it was recorded.)
? DISC	<ul style="list-style-type: none"> A disc which contains data other than music was played. (A disc which contains nonmusic data cannot be played.) <ul style="list-style-type: none"> There is an error in the signal recorded on the disc.

A number or symbol appears in (*) position.

Troubleshooting

Many potential "problems" can be resolved by the owner without calling a service technician. If something seems to be wrong with this product, check the following before calling your authorised SHARP dealer or service centre.

The unit does not turn on.

- Is the AC adaptor disconnected?
- Is the battery exhausted?
- Is the unit in the hold mode?
- Has condensation formed inside the unit?
- Is the unit being influenced by mechanical shock or by static electricity?

No sound is heard from the earphones.

- Is the volume set too low?
- Are the earphones plugged in?
- Are you trying to play a MiniDisc with data on it instead of a MiniDisc containing music?

When the operation buttons are pressed, the unit does not respond.

- Is the unit in the hold mode?
- Is the battery exhausted?
- Is the earphones plug inserted firmly?

Some sounds are skipped.

- Is the battery exhausted?
- Is the unit being subjected to excessive vibration?

The MiniDisc cannot be ejected.

- Has the track number or character information been written on the disc yet?
- Is the unit in the recording or editing mode?

Recording and editing are impossible.

- Is the MiniDisc protected against accidental erasure?
- Is the unit connected properly to the other equipment?
- Is the AC adaptor unplugged or did a power failure occur whilst recording or editing?
- Is the unit in the hold mode?
- Is an optical signal being output from the stereo system? Read the operation manual for the stereo system.

The operation is unstable whilst the PC and the unit are connected.

- Are you using the USB cable that was purchased separately?

The display does not show anything or malfunctions.

- Is the PC out of order?
- Are you using another application with this programme simultaneously?

Editing is not possible.

- Are the PC and the MD portable recorder connected improperly?
- Is the MD recorder in the hold mode?
- Is a commercial playback-only MD inserted?

Maintenance

■ If trouble occurs

When this product is subjected to strong external interference (mechanical shock, excessive static electricity, abnormal supply voltage due to lightning, etc.) or if it is operated incorrectly, it may malfunction.

Should a failure occur, the lid may not open by sliding the OPEN lever.

If such a problem occurs, do the following:

1. Unplug the AC adaptor from the wall socket.
2. Remove the battery.
3. Leave the unit completely unpowered for approximately 30 seconds.
4. Plug the AC adaptor back into the wall socket.
5. After about 30 seconds, press the ►|| button as a test.

■ Moisture condensation

When the unit has condensation inside, the disc signals cannot be read, and the unit may not function properly.

In the following cases, condensation may form inside the unit.

- Shortly after turning on a heater.
- When the unit is placed in a room where there is excessive steam or moisture.
- When the unit is moved from a cool place to a warm place.

To remove condensation:

Remove the MiniDisc and leave the unit for approximately 1 hour. The condensation should evaporate and the unit will work properly.

■ Cleaning

When the unit becomes dirty

Clean it with a soft cloth. When the unit is excessively dirty, use a soft cloth dampened in water (external surfaces only).

Clean the plugs and the connecting sockets.

If the plugs or sockets are dirty, noise may be heard. Cleaning will prevent noise.



Caution:

- Do not use chemicals for cleaning (petrol, paint thinner, etc.). It may damage the cabinet finish.
- Do not apply oil to the inside of the unit. It may cause malfunctions.

Specifications

As a part of our policy of continuous improvement, SHARP reserves the right to make design and specification changes for product improvement without prior notice. The performance specification figures indicated are nominal values of production units. There may be some deviations from these values in individual units.

Power source:	DC 3 V: AC adaptor (AC 110 - 240 V, 50/60 Hz) DC 1.5 V: Commercially available, "AA" size (LR6), alkaline battery x 1
Power consumption:	60 mA (AC adaptor)
Output power:	RMS: 16 mW (8 mW + 8 mW) (0.2 % T.H.D.)
Dimensions:	Width: 83 mm (3-9/32") Height: 28 mm (1-1/8") Depth: 76 mm (3") Excluding the projection around the USB connection terminal
Weight:	117 g (0.26 lbs.) without battery
Input socket:	Line/optical digital
Output socket:	Earphones (impedance: 32 ohms)
Type:	Portable MiniDisc recorder
Signal readout:	Non-contact, 3-beam semiconductor laser pickup
Audio channels:	Stereo 2 channels/monaural 1 channel
Frequency response:	20 - 20,000 Hz (± 3 dB)
Rotation speed:	Approx. 400 - 1,800 rpm CLV (Playback), approx. 400 - 2,700 rpm CLV (Recording)
Error correction:	ACIRC (Advanced Cross Interleave Reed-Solomon Code)
Coding:	ATRAC/ATRAC3 (Adaptive TRansform Acoustic Coding), 24-bit computed type
Recording method:	Magnetic modulation overwrite method
Sampling frequency:	44.1 kHz (32 kHz and 48 kHz signals are converted to 44.1 kHz, and then recorded.)
Wow and flutter:	Unmeasurable (less than ± 0.001 % W. peak)

Battery life:

	Stereo		2 times long		4 times long	
When using a commercially available, high capacity, "AA" size (LR6), alkaline battery	Continuous recording: Approx. 4 hours	Continuous play: Approx. 44 hours	Continuous recording: Approx. 7 hours	Continuous play: Approx. 62 hours	Continuous recording: Approx. 11 hours	Continuous play: Approx. 75 hours

- The continuous recording time is for analogue inputs when the volume level is set to "VOL 0".
- The continuous play time shows the value when the volume level is set to "VOL 15".
- The above values are the standard values when the unit is used at an ambient temperature of 25°C (77°F).
- The operating time when using an alkaline battery may be different, depending on the type and manufacturer of the battery, and on the operating temperature.

Input sensitivity:

	Reference input level	Input impedance
LINE	100 mV	20 k ohms

Output level:

	Specified output	Maximum output level	Load impedance
Ear-phones	-	8 mW + 8 mW	32 ohms
LINE	125 mV (-12 dB) *1	-	10 k ohms

*1 When using the supplied output conversion cable.

TERMS OF GUARANTEE

Subject to the terms listed below, Sharp Electronics (U.K.) Ltd. (hereinafter called "the Company") guarantee to provide for the repair of, or at its option replace this Sharp Equipment, or any component thereof, (other than batteries), which is faulty or below standard, as a result of inferior workmanship or materials.

The conditions of this guarantee are:

1. The guarantee shall only apply to defects which occur within one year from the date of purchase, provided that this equipment is sent to the repair address within this period.
2. This guarantee covers equipment intended for private domestic use only. This guarantee does not apply to equipment used in the course of a business, trade or profession.
3. The guarantee does not cover MiniDiscs or batteries.
4. This guarantee does not cover any faults or defects caused by accident, misuse, fair wear and tear, neglect, tampering with the equipment, or any attempt at adjustment or repair other than by a Service Facility appointed by Sharp.
5. In the unlikely event of a defect occurring, the product must be returned to the Company's repair centre with proof of purchase. A postage paid label and a fault report form are supplied with the product for this purpose. It is your responsibility to ensure that the packaging is adequate, and to obtain proof of posting. Further details of the repair service, which is available after the guarantee period on a chargeable basis, and additional report forms and labels can be obtained by telephoning 0870 738 0000.
6. No person has any authority to vary the terms or conditions of this guarantee.
7. This guarantee is offered as an additional benefit to the consumer's statutory rights and does not affect these rights in any way.

SHARP

SHARP ELECTRONICS (U.K.) LTD.

Sharp House, Thorp Road, Newton Heath, Manchester, M40 5BE

SHARP CORPORATION

TINSE0550AWZZ (E)
03G R YT ①

IM-DR410E (TINSE0550AWZZ)