

**SONY**<sup>®</sup>

3-223-666-12(1)

# ***Portable MiniDisc Recorder***

---

Operating Instructions



**MDLP**



***MZ-R700/R700PC/R700DPC***

©2000 Sony Corporation

## WARNING

To prevent fire or shock hazard, do not expose the unit to rain or moisture.

To avoid electrical shock, do not open the cabinet. Refer servicing to qualified personnel only.

Do not install the appliance in a confined space, such as a bookcase or built-in cabinet.

### Caution

The use of optical instruments with this product will increase eye hazard.

Listening for many hours at maximum volume may damage your hearing.

CAUTION — INVISIBLE LASER RADIATION WHEN OPEN

AVOID EXPOSURE TO BEAM

### Information

IN NO EVENT SHALL SELLER BE LIABLE FOR ANY DIRECT, INCIDENTAL OR CONSEQUENTIAL DAMAGES OF ANY NATURE, OR LOSSES OR EXPENSES RESULTING FROM ANY DEFECTIVE PRODUCT OR THE USE OF ANY PRODUCT.

#### For customers in the USA

##### Owner's Record

The serial number is located at the rear of the disc compartment lid and the model number is located at the top and bottom. Record the serial number in the space provided below. Refer to them whenever you call upon your Sony dealer regarding this product.

Model No. \_\_\_\_\_  
Serial No. \_\_\_\_\_

This equipment has been tested and found to comply with the limits for a Class B digital device, pursuant to Part 15 of the FCC Rules. These limits are designed to provide reasonable protection against harmful interference in a residential installation. This equipment generates, uses, and can radiate radio frequency energy and, if not installed and used in accordance with the instructions, may cause harmful interference to radio communications. However, there is no guarantee that interference will not occur in a particular installation. If this equipment does cause harmful interference to radio or television reception, which can be determined by turning the equipment off and on, the user is encouraged to try to correct the interference by one or more of the following measures:

- Reorient or relocate the receiving antenna.
- Increase the separation between the equipment and receiver.
- Connect the equipment into an outlet on a circuit different from that to which the receiver is connected.
- Consult the dealer or an experienced radio/TV technician for help.

This device complies with Part 15 of the FCC Rules. Operation is subject to the following two conditions: (1) This device may not cause harmful interference, and (2) this device must accept any interference received, including interference that may cause undesired operation.

You are cautioned that any changes or modifications not expressly approved in this manual could void your authority to operate this equipment.

### RECYCLING NICKEL-CADMmium BATTERIES

Nickel-Cadmium batteries are recyclable. You can help preserve our environment by returning your unwanted batteries to your nearest point for collection, recycling or proper disposal.

**Note:** In some areas the disposal of Nickel-Cadmium batteries in household or business trash may be prohibited.

RBRC (Rechargeable Battery Recycling Corporation) advises you about spent battery collection by the following phone number.

**Call toll free number: 1-800-822-8837 (United States and Canada only)**

**Caution:** Do not handle damaged or leaking Nickel-Cadmium batteries.



***For customers in Canada***

To prevent electric shock, do not use this polarized AC plug with an extension cord, receptacle or other outlet unless the blades can be fully inserted to prevent blade exposure.

***For Customers in Australia***

If the supply cord of the AC power adaptor is damaged, the AC power adaptor must be returned to the manufacturer or his agent for the cord to be replaced.



**N50** The C-Tick mark on the Walkman is valid only for the products marketed in Australia.



The CE mark on the unit is valid only for products marketed in the European Union.

Certain countries may regulate disposal of the battery used to power this product. Please consult with your local authority.

WALKMAN and  are trademarks of Sony Corporation.

---

## Table of contents

Looking at the controls .....	8
Getting started! .....	11
Recording an MD right away! .....	14
Playing an MD right away! .....	18

### **Various ways of recording**

Two ways of connecting to a sound source .....	21
Recording with analog input (line cable required) .....	23
Recording for long times .....	24
To start/stop recording in sync with the source player (Synchro-recording) .....	25
Recording without overwriting existing material .....	27
Recording from a microphone .....	28
Adjusting the recording level manually (Manual recording) .....	29
Checking the remaining time or the recording position .....	31

### **Various ways of playback**

Playing tracks repeatedly .....	33
Emphasizing bass (DIGITAL MEGA BASS) .....	35
Checking the remaining time or the playing position .....	36
Protecting your hearing (AVLS) .....	37
Locking the controls (HOLD) .....	38
Connecting to a stereo system .....	39

### **Editing recorded tracks**

Erasing tracks .....	41
To erase a track .....	41
To erase the whole disc .....	42
Adding a track mark .....	43
Erasing a track mark .....	44
Moving recorded tracks .....	45
Labeling recordings .....	47

### **Power sources**

Battery life .....	50
--------------------	----

### **Additional information**

Precautions .....	51
Troubleshooting .....	56
System limitations .....	58
Messages .....	60
Specifications .....	63
What is an MD? .....	65

## Looking at the controls

See pages in ( ) for more details.

### The recorder

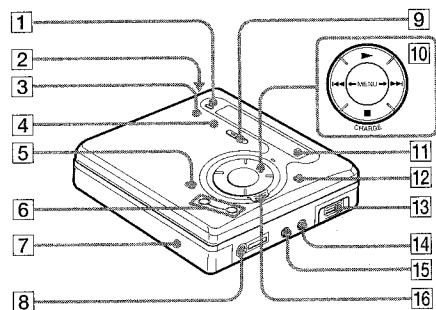

- |  |  |
|--|--|
| 1 REC MODE button (24)                       | 10 ◀ MENU ▶ button (26) (33) (42)          |
| 2 OPEN button (12)                           | ▶ (play) button (15) (18)                  |
| 3 T MARK button (42)                         | ◀◀ / ▶▶ (search/AMS) button (15) (19) (44) |
| 4 END SEARCH button (15) (48)                | ■ (stop)/CHARGE button (11) (15) (18) (25) |
| 5    (pause) button (15) (19) (29) (44) (48) | 11 Display window (30)                     |
| 6 VOL +/- button (18) (48)                   | 12 ENTER button (25) (33) (41)             |
| 7 DC IN 3V jack (11) (14) (51)               | 13 Battery compartment (11)                |
| 8 🎧 (headphones) jack (12) (39)              | 14 LINE IN (OPTICAL) jack (14) (23)        |
| 9 REC (record) switch (15) (23)              | 15 MIC (PLUG IN POWER) jack (28)           |
|  | 16 HOLD switch (12) (38)                   |

### The display window

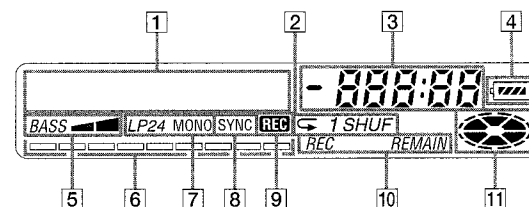

- |   |   |
|---|---|
| 1 Character information display (32) (34)<br>Displays the disc and track names, error messages, track numbers, etc. | 9 REC indication (15)<br>Lights up while recording. When flashing, the recorder is in record standby mode.  |
| 2 Play mode indication (34)<br>Shows the play mode of the MD.   | 10 REC REMAIN/REMAIN (remaining time/tracks) indication (32) (36)<br>Lights up along with the remaining time of the track, the remaining time of the MD, or the remaining number of tracks. |
| 3 Time display  | 11 Disc indication<br>Shows that the disc is rotating for recording, playing or editing an MD.  |
| 4 Battery indication (50)<br>Shows approximate battery condition.   |   |
| 5 Mega bass indication (35)   |   |
| 6 Level meter (30)<br>Shows the volume of the MD being played or recorded.  |   |
| 7 Recording mode (LP2/LP4/MONO) indication  |   |
| 8 SYNC (synchro-recording) indication   |   |

## The remote control

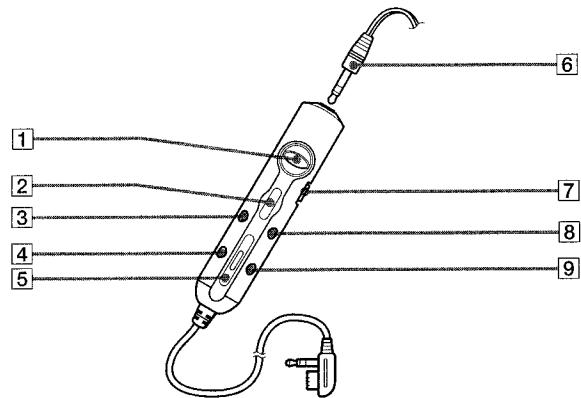

- |   |  |
|---|--|
| <p>1  (search/AMS/play) •  button (18) (31) (33) (42) (48)</p> <p>2  (stop) • ENTER button (18) (31) (33) (42)</p> <p>3  (pause) • CAPS button (19) (44) (48)</p> <p>4 EDIT button (33) (41) (48)</p> <p>5 VOL +/- -buttons (18) (48)</p> | <p>6 Headphones/earphones<br/>Can be replaced with optional headphones/earphones.</p> <p>7 HOLD switch (38)<br/>Slide to lock the controls of the remote control.</p> <p>8 T MARK button (42) (48)</p> <p>9 DELETE button (48)</p> |
|---|--|

## Getting started!

Charge the rechargeable battery before using. Even if the rechargeable battery is not charged, you can use the recorder as long as the AC power adaptor is connected.

### 1 Insert the rechargeable battery.

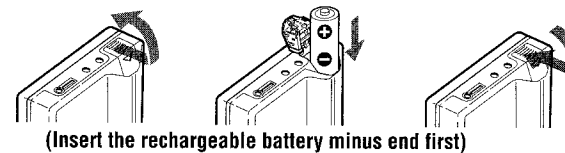

### 2 Charging the rechargeable battery.

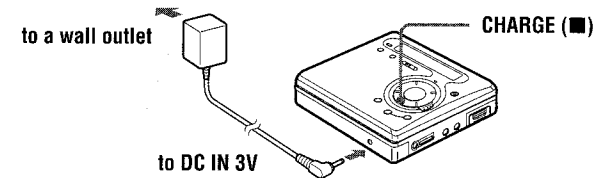

1 Connect the supplied AC power adaptor.

2 Press CHARGE (■).

“Charging” flashes, appears in the display, and charging starts. When charging is completed, the battery indication disappears.

Full charging of a completely discharged rechargeable battery takes about 3 hours. To cancel charging, press CHARGE (■).

3 Disconnect the supplied AC power adaptor.



### 3 Make connections and unlock the control.

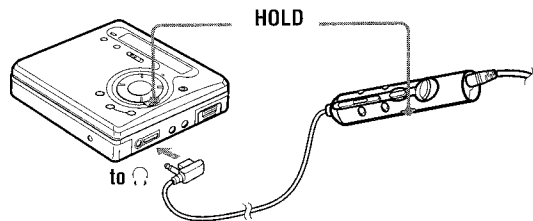

① Connect the supplied headphones/earphones with the remote control to .

② Slide HOLD in the opposite direction of the arrow () to unlock the controls.

### 4 Insert an MD. (Use a recordable MD for recording.)

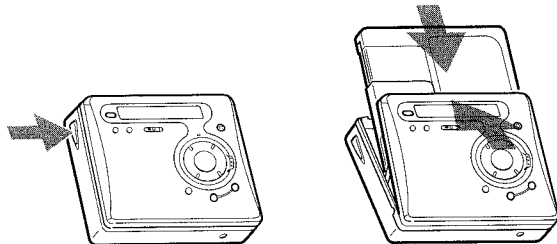

① Press OPEN to open the lid.

② Insert an MD with the label side facing front, and press the lid down to close.

### Using on a dry battery

Insert one LR6 (size AA) alkaline dry battery (not supplied) instead of the rechargeable battery.

#### Notes

- If you press CHARGE (■) immediately after charging has completed, charging will begin again. If this happens, press CHARGE (■) again to stop the charging operation since the battery is already fully charged.
- Charging stops when you try to operate the recorder during charging.
- Be sure to use the supplied AC power adaptor.
- Charging time may vary depending on the battery condition.
- When a rechargeable battery is charged for the first time or charged after a long period of disuse, battery life may be shorter than usual. Repeat discharging and recharging a few times. The battery life should return to normal.
- When the battery life of a fully charged rechargeable battery becomes about half the normal life, replace it.
- When carrying the rechargeable battery, keep it in the supplied battery carrying case. It is dangerous to carry the battery out of the case in your pocket or a bag together with metallic objects such as key rings, as this may cause a short circuit.
- Remove the rechargeable battery from the recorder when it is not to be used for a long time.

## Recording an MD right away!

Connect to a digital source using an optical cable (supplied) to make digital recordings. Digital recording is possible even from digital equipment with different sampling rates, such as a DAT deck or a BS tuner, using the built-in sampling rate converter. To record from an analog source, see "Recording with analog input (line cable required)" (page 23). To record from an MD, see "Note on digital recording" (page 54).

**Using the AC power adaptor (supplied) is recommended for recording.**



### Make connections.

(Insert the cables firmly and completely into the appropriate jacks.)

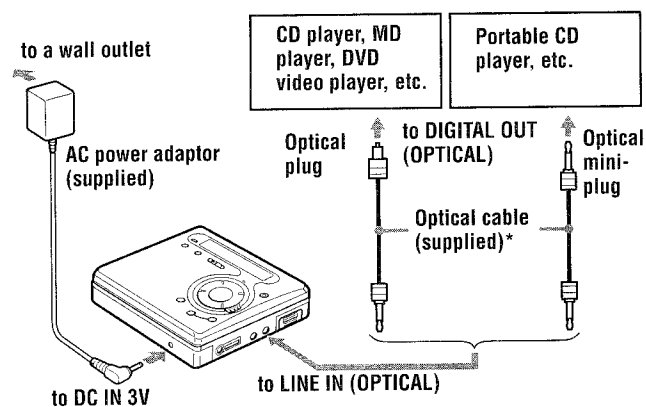

\* The supplied cable consists of one or the other of these cables. The shape of the plugs on the supplied cable may differ, depending on where the recorder was purchased.



## Record an MD.

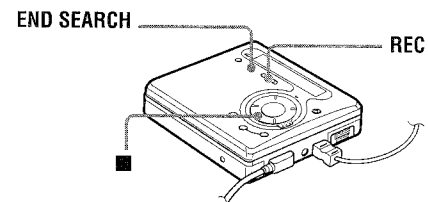

- ① Press and slide REC to the right.  
REC indication lights up in the display and recording starts.
- ② Play the source you want to record.

### To stop recording, press ■.

After you press ■, the recorder will automatically turn off after:

- about 5 minutes when using AC power adaptor.
- about 10 seconds when using batteries.

### Notes

- "Data Save" or "TOC Edit" flashes while data of the recording (the track's start and end points, etc.) is being recorded. Do not move or jog the recorder or disconnect the power source while the indication is flashing in the display.
- The lid does not open until "TOC Edit" disappears in the display.

To	Press
Record from the end of the previous recording <sup>1)</sup>	END SEARCH and then press and slide REC.
Record partway through the previous recording <sup>1)</sup>	▶, ▶▶ or ◀◀ to find the start point of recording and press ■ to stop. Then press and slide REC.
Pause	⏸ <sup>2)</sup> Press ⏸ again to resume recording.



To	Press
Remove the MD	■ and open the lid. <sup>3)</sup> (The lid does not open while “TOC Edit” flashing in the display.)

- <sup>1)</sup> By setting “REC-Posi” to “From End,” recording operations will always start from the end of the previously recorded material (page 27).
- <sup>2)</sup> A track mark is added at the point where you press ■ again to resume recording while pausing; thus the remainder of the track will be counted as a new track.
- <sup>3)</sup> If you open the lid while “REC-Posi” is set to “From Here,” recording will begin with the first track the next time you record. Check the point to start recording on the display.

***If the recording does not start***

- Make sure the recorder is not locked (page 38).
- Make sure the MD is not record-protected (page 54).
- Premastered MDs cannot be recorded over.

***For models supplied with the AC plug adaptor***

If the AC power adaptor does not fit the wall outlet, use the AC plug adaptor.

***Notes***

- If the power supply is disrupted (i.e. the battery is removed or becomes exhausted or the AC power adaptor is disconnected) during a recording or editing operation, or while “TOC Edit” appears in the display, then it will not be possible to open the lid until power is restored.
  - You can make a digital recording only from an optical type output.
  - When recording from a portable CD player, set the CD player to pause, and then do the recording procedure on the recorder.
  - Note the following when recording from a portable CD player:
    - Some portable CD players may not be capable of digital out unless powered by the AC power.
    - Connect the AC power adaptor to the portable CD player and use it on AC power as the power source.
    - Disable any anti-skip function (such as ESP\*) on the portable CD player.
- \* Electronic Shock Protection



- LINE IN (OPTICAL) jack is for both digital and analog input. The recorder automatically recognizes the type of line cable and switches to digital or analog input.
- The level of the recorded sound is adjusted automatically.
- You can monitor the sound during recording. Connect the supplied headphones/earphones with remote control to ⏸ and adjust the volume by pressing VOL +/- . This does not affect the recording level.

## Playing an MD right away!

To use the recorder on a rechargeable battery or dry battery, see "Power sources" (page 50).  
When you operate the recorder with the supplied remote control, use the buttons and control shown in parentheses.

### Play an MD.

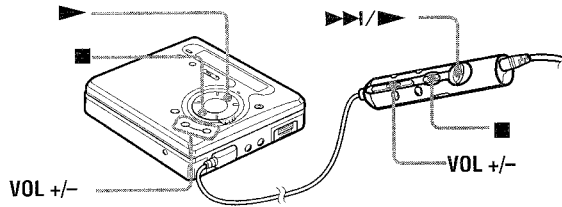

- ① Press **▶** (flip the lever towards **▶▶I/▶▶**).

A short beep sounds in the headphones/earphones when you operate on the remote control.

- ② Press **VOL +/-** to adjust the volume.

The volume will be shown in the display.

#### To stop play, press **■**.

A long beep sounds in the headphones/earphones when you operate on the remote control.  
Playback starts from the point you last stopped playing.

After you press **■**, the recorder will automatically turn off after:

- about 5 minutes when using AC power adaptor.
- about 10 seconds when using batteries.

To	Press (Beeps in the headphones/earphones <sup>2)</sup> )
Find the beginning of the current track	<b>I&lt;&lt;&lt;</b> once (flip the lever towards <b>I&lt;&lt;&lt;</b> ). (Three short beeps)
Find the beginning of the next track	<b>▶▶I</b> once (flip the lever towards <b>▶▶I/▶▶</b> ). (Two short beeps)
Pause	<b>II</b> (Continuous short beeps) Press <b>II</b> again to resume play.
Go backwards while playing <sup>1)</sup>	hold down <b>I&lt;&lt;&lt;</b> (flip and hold the lever towards <b>I&lt;&lt;&lt;</b> ).
Go forward while playing <sup>1)</sup>	hold down <b>▶▶I</b> (flip and hold the lever towards <b>▶▶I/▶▶</b> ).
Remove the MD	<b>■</b> (a long beep) and open the lid. <sup>3)</sup>

<sup>1)</sup> To go backward or forward quickly without listening, press **II** and hold down **I<<<** or **▶▶I** (flip and hold the lever towards **I<<<** or **▶▶I/▶▶** on the remote control).

<sup>2)</sup> You can turn off the beep sound (page 39).

<sup>3)</sup> Once you open the lid, the point to start play will change to the beginning of the first track.

### **G-PROTECTION function**

The G-PROTECTION function has been developed to provide excellent protection against sound skipping during many active uses. This function provides a higher level of shock protection during playback than the traditional one.

### **If the play does not start**

Make sure the recorder is not locked (page 38).



Playback will switch automatically to match the recording mode of the material (stereo, LP2, LP4, or monaural).

### **Notes**

- To prevent recorder malfunction, do not use a remote control that was supplied with another Sony portable MD model.
- Sound may skip if:
  - the recorder receives stronger continuous shock than expected.
  - a dirty or scratched MiniDisc is played.

## **Various ways of recording**

### **Two ways of connecting to a sound source**

The input jack of this recorder works as both digital and analog input jacks. Connect the recorder to a CD player or a cassette recorder using either digital (optical) input or analog (line) input. To record, see “Recording an MD right away!” (page 14) to record using digital (optical) input, and “Recording with analog input (line cable required)” (page 23) to record using analog (line) input.

### **Difference between digital (optical) and analog (line) inputs**

<b>Difference</b>	<b>Digital (optical) input</b>	<b>Analog (line) input</b>
Connectable source	Equipment with a digital (optical) output jack	Equipment with an analog (line) output jack
Usable cord	Optical cable (with an optical or an optical-mini plug) (page 14)	Line cable (with 2 phono plugs or a stereo-mini plug) (page 23)
Signal from the source	Digital	Analog Even when a digital source (such as a CD) is connected, the signal sent to the recorder is analog.

Difference	Digital (optical) input	Analog (line) input
Recorded track numbers	Marked (copied) automatically <ul style="list-style-type: none"> <li>at the same positions as the source (when the sound source is a CD or an MD).</li> <li>after more than 2 seconds of blank or low-level segment (with a sound source other than CD or MD).</li> <li>when the recorder is paused during synchro-recording (the recorder pauses automatically when it encounters a section with no audio signal for 3 seconds or more).</li> </ul> You can erase unnecessary marks after recording. ("Erasing a track mark", page 44).	Marked automatically <ul style="list-style-type: none"> <li>after more than 2 seconds of blank or low-level segment.</li> <li>when the recorder is paused while recording.</li> </ul> You can erase unnecessary marks after recording ("Erasing a track mark", page 44).
Recorded sound level	Same as the source. Can also be adjusted manually (Digital REC level control) ("Adjusting the recording level manually (Manual recording)", page 29).	Adjusted automatically. Can also be adjusted manually ("Adjusting the recording level manually (Manual recording)", page 29).

**Note**

- Track marks may be copied incorrectly:
- when you record from some CD players or multi disc players using digital (optical) input.
  - when the source is in shuffle or program play mode while recording using digital (optical) input. In this case, play the source in normal play mode.
  - when recording BS or CS programs through digital (optical) input.

**Recording with analog input (line cable required)**

The sound will sent from the connected equipment as analog signal but will be recorded digitally on the disc.

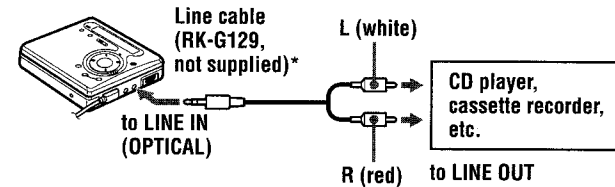

\* Use the connecting cords without an attenuator. To connect to a portable CD player having a stereo mini-jack, use the RK-G136 connecting cord (not supplied).

- 1 Press and slide REC to the right.  
REC indication lights up in the display and recording starts.
- 2 Play the source you want to record.  
For recording operations, see "Recording an MD right away!" (page 14). To record from a portable CD player, set the CD player to pause and then start recording.

**LINE IN (OPTICAL) jack is for both digital and analog input**

The recorder automatically recognizes the type of line cable and switches to digital or analog input.

**Note**

If you temporarily stop a recording operation by pressing **II**, a track mark will be added at that point when you press **II** again to resume recording. The recording continues from on a new track.

## Recording for long times

Select each recording mode according to the recording time that you want.

Stereo recording is possible at 2 times (LP2) or 4 times (LP4) the normal recording time.

MDs recorded in monaural, LP2, or LP4 mode can be played back only on MD players or recorders with a monaural, LP2, or LP4 playback mode.

Audio components that support the LP2 or LP4 modes are indicated by the **MDLP** or **MDLP** logo marks.

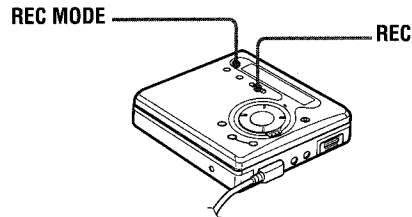

- 1 Press REC MODE repeatedly to select the desired recording mode.

Each time you press REC MODE, the display changes as follows.

Recording mode <sup>1)</sup>	Display	Recording time <sup>3)</sup>
Stereo (normal)	(none)	Approx. 80 min.
LP2 stereo	LP2	Approx. 160 min.
LP4 stereo	LP4	Approx. 320 min.
Monaural <sup>2)</sup>	MONO	Approx. 160 min.

<sup>1)</sup> For better sound quality, record in normal stereo or LP2 mode.

<sup>2)</sup> If you record a stereo source in monaural, the sounds from left and right will be mixed.

<sup>3)</sup> When using an 80-minute recordable MD

- 2 Press and slide REC to the right.

- 3 Play the sound source.

### To stop recording, press ■.

The recorder remains the previous setting of the recording mode when you record the next time.

#### Notes

- It is recommended that you use the supplied AC power adaptor for long recordings.
- If you try to play an MD recorded in LP2 or LP4 on MD players or recorders that do not support these modes, playback will not start and "LP:" will appear on the display.
- Sound recorded through digital (optical) input can be monitored in stereo through headphones/earphones, etc.
- When you record in LP4 mode, momentary noise may be produced on very rare occasions with certain sound sources. This is because of the special digital audio compression technology that enables a recording time 4 times longer than normal. If noise is produced, it is recommended that you record in normal stereo or LP2 mode to obtain better sound quality.

## To start/stop recording in sync with the source player (Synchro-recording)

You can easily make digital recordings of a digital source on an MD. Before synchro-recording, make connections to the digital source with a digital cable, and insert a recordable MD.

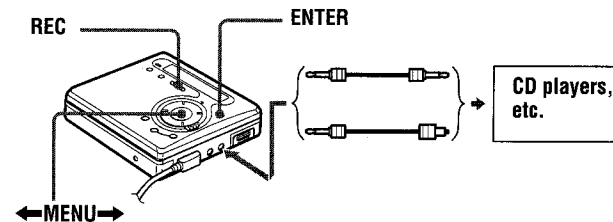

- 1 Press ENTER while the recorder is stopped.

**continued**

- 2 Press **←MENU→** repeatedly until “SYNC REC” flashes in the display, and then press ENTER.

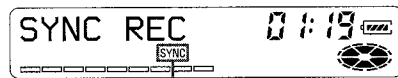

SYNC indicator

“SYNC” does not appear if optical cable is not connected to the recorder.

- 3 Press **←MENU→** repeatedly until “SYNC ON” flashes in the display, and then press ENTER.
- 4 Press and slide REC to the right.  
The recorder stands by for recording.
- 5 Play the source sound.  
The recorder starts recording when it receives the playing sound.

**To stop recording, press ■.**



- You cannot pause manually during synchro-recording.
- When there is no sound from the player for more than 3 seconds during synchro-recording, the recorder goes into the standby mode automatically. When the sound comes from the player again, the recorder resumes synchro-recording. If the recorder is kept in the standby mode for 5 minutes or longer, the recorder stops automatically.
- For longer recording, follow step 1 of “Recording for long times” (page 24) to select the recording mode, and then do the procedure of synchro-recording.

**Notes**

- Do not change SYNC REC setting while recording. Recording may not be done properly.
- Even when there is no recorded sound on the sound source, there may be cases when recording does not pause automatically during synchro-recording due to the noise level emitted from the sound source.
- If a silent portion is encountered for 2 seconds or more during synchro-recording from a sound source other than a CD or an MD, a new track mark is automatically added at the point where the silent portion ends.

- Synchro-recording cannot be done if the connecting cord is not an optical cable, or if the cable is connected to the MIC (PLUG IN POWER) jack.
- You cannot manually change the recording mode or the recording level during synchro-recording.

**Recording without overwriting existing material**

If you wish to avoid overwriting the current contents of an MD, do the following procedure. All new material will then be recorded from the end of the current contents.

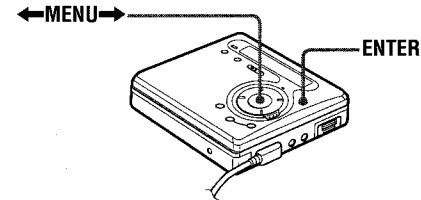

- 1 While the recorder is stopped, press ENTER.
- 2 Press **←MENU→** repeatedly until “REC-Posi” flashes in the display, and then press ENTER.
- 3 Press **←MENU→** repeatedly until “From End” flashes in the display, and then press ENTER.

**To start recording from the current point**

Select “From Here” in step 3.

## Recording from a microphone

Connect a stereo microphone (ECM-717, ECM-MS907, ECM-MS957, etc.; not supplied) to the MIC (PLUG IN POWER) jack.

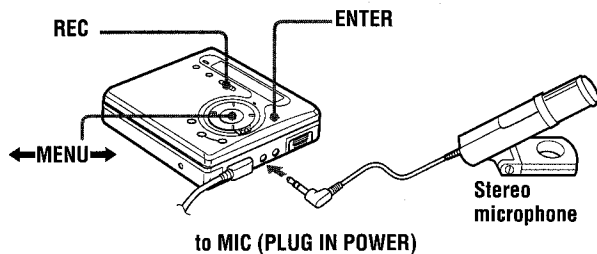

- 1 Insert a recordable MD and then press and slide REC to the right. For other operations, see "Recording an MD right away!" (page 14).

### Notes

- You cannot record through the microphone while an optical cable is connected to the LINE IN (OPTICAL) jack. The recorder automatically switches input in the following order; optical input, microphone input, and analog input.
- The microphone may pick up the operating sound of the recorder itself. Use the microphone away from the recorder in such cases.

## Adjusting the recording level manually (Manual recording)

When you record, the sound level is adjusted automatically. If necessary, you can set the level manually.

### Note

Adjust the recording level while the recorder is in standby mode. You cannot adjust it while recording.

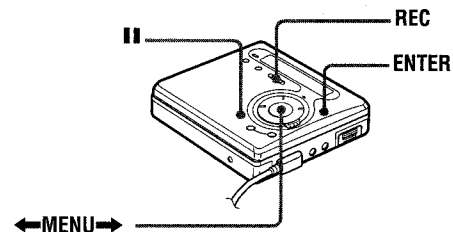

- 1 While holding down II, press and slide REC to the right. The recorder stands by for recording.
- 2 Press ENTER, press ←MENU→ repeatedly until "RecVolume" flashes in the display, and then press ENTER again.
- 3 Press ←MENU→ repeatedly until "ManualREC" flashes in the display, and then press ENTER.



To switch back to the automatic control, Press ←MENU→ repeatedly until "Auto REC" flashes in the display, and then press ENTER.

- 4 Play the source.

**continued**

- 5** While observing the level meter in the display, adjust the recording level by pressing **←MENU→**.  
Set the level so that the level meter reaches around **-12 dB** mark above the display window.

If the sound is too high, lower the recording level until the level meter just barely reaches the **OVER** mark above the display window.

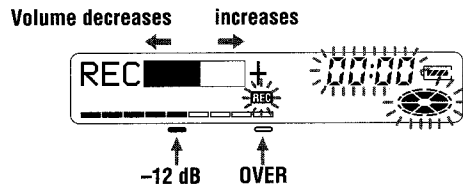

Recording does not start in this step.

If your source is an externally connected component, be sure to cue the source to the beginning of the material to be recorded before you start playback.

- 6** Press **||** again to start recording.

**To stop recording, press ■.**

The recording level control is switched back to automatic control when you record the next time.

**Notes**

- The recording level cannot be adjusted while recording is in progress. If you want to adjust the recording level after you have started the recording, press **||** to pause the recorder. Then do the procedure from step 5.
- You cannot adjust the recording level manually during synchro-recording.

**Checking the remaining time or the recording position**

You can check the remaining time, track number, etc. when recording or during stop.

When you operate the recorder with the supplied remote control, use the buttons and controls shown in parentheses.

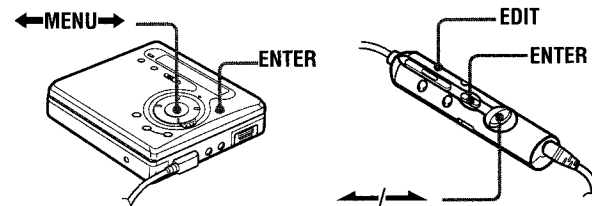

- 1** While the recorder is recording or stopped, press **ENTER** (**EDIT** for 2 seconds or more), press **←MENU→** (flip the lever towards **←** or **→**) repeatedly until "DISPLAY" flashes in the display, and then press **ENTER** (**ENTER**) again.
- 2** Press **←MENU→** (flip the lever towards **←** or **→**) repeatedly until the information you want flashes in the display. Each time you press **MENU→** (flip the lever towards **→**), the display changes as follows.

**continued**



## Display window

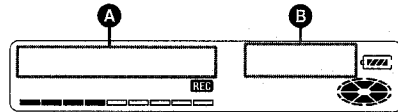

### On **A**

#### LapTime

The elapsed time of the current track.

#### RecRemain<sup>1)</sup>

The remaining recordable time.

#### AllRemain<sup>2)</sup>

The remaining time after the current location.

<sup>1)</sup>“REC REMAIN” begins flashing in the display when the remaining time on the disc reaches 3 minutes or less.

<sup>2)</sup>Appears only when the recorder is stopped.

### **3** Press ENTER (ENTER).

The information selected in step 2 appears in **A** and **B**.

**A** — track number, track name<sup>3)</sup>, or disc name<sup>4)</sup>.

**B** — the information selected in step 2.

<sup>3)</sup>Appears only when “RecRemain” is selected while the recorder is in stop mode and the track is labeled.

<sup>4)</sup>Appears only when “AllRemain” is selected while the recorder is in stop mode, and the disc is labeled.



If you want to check the playing position or track name while playing, see page 36.

## Various ways of playback

When you operate the recorder with the supplied remote control, use the buttons and controls shown in parentheses.

### Playing tracks repeatedly

You can play tracks repeatedly in three ways — all repeat, single repeat, and shuffle repeat.

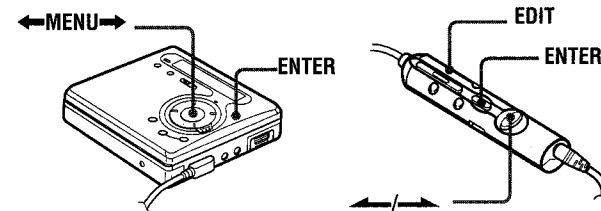

**1** While the recorder is playing or stopped, press ENTER (EDIT for 2 seconds or more), press **←MENU→** (flip the lever towards **←** or **→**) repeatedly until “PLAY MODE” flashes in the display, and then press ENTER (ENTER) again.

**2** Press **←MENU→** (flip the lever towards **←** or **→**) repeatedly to select the play mode, and then press ENTER (ENTER).

Each time you press **MENU→** (flip the lever towards **→**), the display item indicated by **A** changes as follows.

Pressing ENTER (ENTER) while **A** is flashing causes the play mode to change.

The new mode then appears in the window indicated by **B**.

**continued**

### Display window

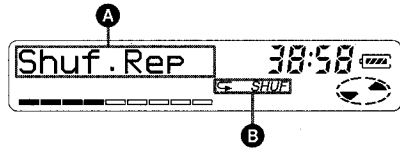

- On **A/B**
- Normal**/(none)  
All the tracks are played once.
- ↓
- AllRepeat**/C  
All the tracks are played repeatedly.
- ↓
- 1 Repeat**/C 1  
A single track is played repeatedly.
- ↓
- Shuf.Rep**/C **SHUF**  
After the currently selected track finishes playing, the remaining tracks are played repeatedly in random order.

## Emphasizing bass (DIGITAL MEGA BASS)

The Mega Bass function intensifies low frequency sound for richer quality audio reproduction. It affects only the sound from the headphones/earphones.

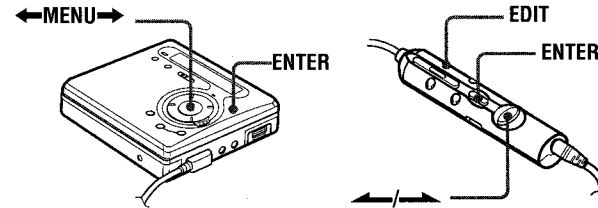

- 1** Press ENTER (EDIT for 2 seconds or more), press ←MENU→ (flip the lever towards ← or →) repeatedly until "BASS" flashes in the display, and then press ENTER (ENTER) again.
- 2** Press ←MENU→ (flip the lever towards ← or →) to select the item, and then press ENTER (ENTER).  
Each time you press MENU→ (flip the lever towards →), **A** and **B** change as follows.

### Display window

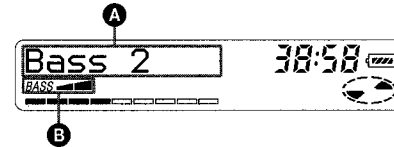

continued

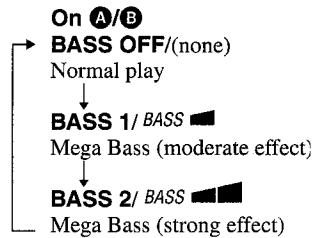

#### Notes

- If the sound becomes distorted when emphasizing bass, turn down the volume.
- The Mega Bass function does not affect the sound that is being recorded.

## Checking the remaining time or the playing position

You can check the track name, disc name, etc. during playback.

- 1 While the recorder is playing, follow steps 1 and 2 of “Checking the remaining time or the recording position” (page 31). The display changes as follows.

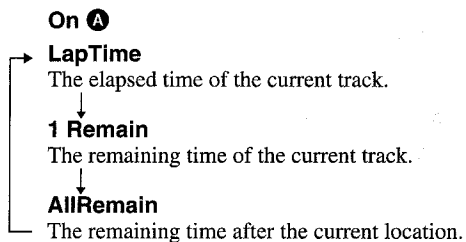

- 2 Press ENTER (ENTER).

The display changes as follows.

The information selected in step 2 appears in **A** and **B**.

**A** — track number, track name<sup>1)</sup>, or disc name<sup>2)</sup>.

**B** — the information selected in step 2.

<sup>1)</sup>Appears only when “1 Remain” is selected and the track is labeled.

<sup>2)</sup>Appears only when “AllRemain” is selected while the recorder is in stop mode, and the disc is labeled.



If you want to check the remaining time or the recording position while recording or in stop mode, see page 31.

## Protecting your hearing (AVLS)

The AVLS (Automatic Volume Limiter System) function keeps down the maximum volume to protect your ears.

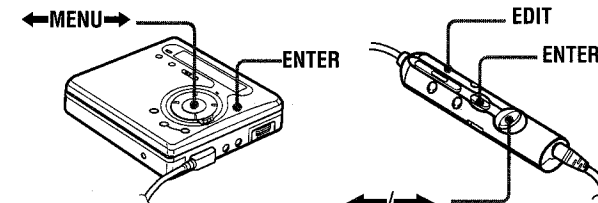

- 1 Press ENTER (EDIT for 2 seconds or more), press **←MENU→** (flip the lever towards **←** or **→**) repeatedly until “AVLS” flashes in the display, and then press ENTER (ENTER) again.

- 2 Press **←MENU→** (flip the lever towards **←** or **→**) repeatedly until “AVLS ON” flashes in the display, and then press ENTER (ENTER).

When you try to turn the volume too high, “AVLS” flashes in the display. The volume is kept to a moderate level.

### To cancel AVLS

Select "AVLS OFF" in step 2.

### Locking the controls (HOLD)

To prevent the buttons from being accidentally operated when you carry the recorder, use this function.

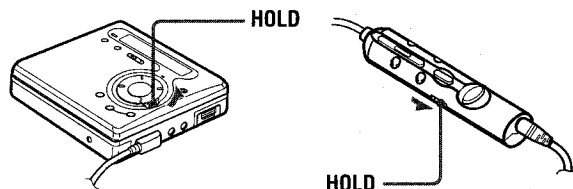

- 1 Move HOLD in the direction of the →.

### To unlock the controls

Move HOLD in the opposite direction of the arrow to unlock the controls.

### Connecting to a stereo system

Connect the  jack of the recorder to the LINE IN jacks of an amplifier or a tape recorder with a line cable (RK-G129 or RK-G136, not supplied). The output is analog. The recorder plays the MD digitally and sends analog signals to the externally connected equipment.

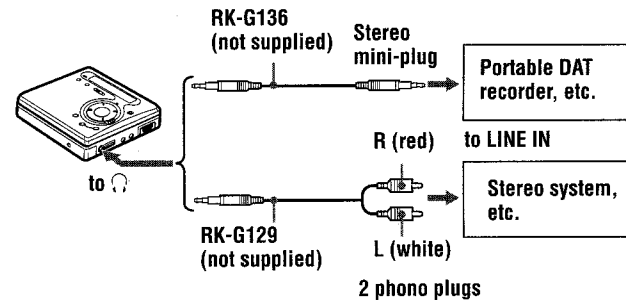

### When the recorder is connected to an another audio component through the supplied remote control.

When connecting a line cable (not supplied) to the headphones/earphones jack of the remote control, be sure to set the "BEEP" setting to "BEEP OFF." This keeps the beep sound out of the recorded signal or the output from the externally connected equipment.

- 1 Press ENTER, press ←MENU→ repeatedly until "BEEP" flashes in the display, and then press ENTER again.
- 2 Press ←MENU→ repeatedly until "BEEP OFF" flashes in the display, and then press ENTER.

### To turn on the beep sound

Select "BEEP ON" in step 2.

### Notes

- Even when connecting to the externally connected equipment, the Mega Bass function is operative. If you do not want the effect of the Mega Bass function on your recording or the output from the externally connected equipment, set "BASS" to "BASS OFF" (page 35).
- When recording to an externally connected equipment, press VOL + repeatedly to raise the volume level to maximum, which is optimum for recording to an externally connected equipment. If, however, this level produces distortion in the recording, press VOL - several times to lower the level (to that shown in the illustration below).

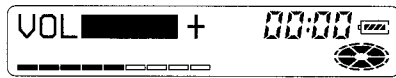

## Editing recorded tracks

You can edit your recordings by adding/erasing track marks or labeling tracks and MDs. Pre-mastered MDs cannot be edited.

### Notes on editing

- Do not move or jog the recorder while "TOC Edit"\* is flashing in the display.
- You cannot edit tracks on an MD that is record-protected. Before editing tracks, close the tab on the side of the MD (page 54).
- If you perform an editing operation while playing, be sure not to turn the power off until "TOC Edit" disappears in the display.
- The lid does not open until "TOC Edit" disappears in the display after editing.

\* TOC = Table of Contents

When you operate the recorder with the supplied remote control, use the buttons and controls shown in parentheses.

## Erasing tracks

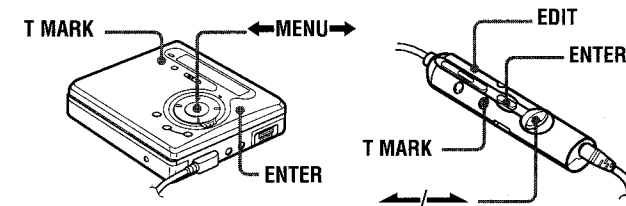

### To erase a track

Note that once a recording has been erased, you cannot retrieve it. Make sure of the track you are erasing.

- 1 While playing the track you want to erase, press ENTER (EDIT for 2 seconds or more).

**continued**

- 2** Press **←MENU→** (flip the lever towards **←** or **→**) repeatedly until "EDIT" flashes in the display, and then press ENTER (ENTER) again.  
"🎵: Name" flashes in the display, and the recorder plays the selected track repeatedly.
- 3** Press **←MENU→** (flip the lever towards **←** or **→**) repeatedly until "🎵: Erase" flashes in the display, and then press ENTER (ENTER).  
"Erase OK?" and "PushENTER" appear alternately in the display.  
To cancel erasing, press T MARK (T MARK).
- 4** Press ENTER (ENTER) again.  
The track is erased and the next track starts to play. All the tracks after the one erased are automatically renumbered.

#### To erase a part of a track

Add track marks at the beginning and the end of the part you want to erase, then erase the part (page 43).

#### To erase the whole disc

You can quickly erase all the tracks and data of the MD at the same time.

Note that once a recording has been erased, you cannot retrieve it. Be sure to check the contents of the disc you want to erase.

- 1** While the recorder is stopped, press ENTER (EDIT for 2 seconds or more).
- 2** Press **←MENU→** (flip the lever towards **←** or **→**) repeatedly until "EDIT" flashes in the display, and then press ENTER (ENTER) again.  
"🎵 : Name" flashes in the display.

- 3** Press **←MENU→** (flip the lever towards **←** or **→**) repeatedly until "🎵: Erase" flashes in the display, and then press ENTER (ENTER).  
"All Erase?" and "PushENTER" appear alternately in the display.  
To cancel erasing, press T MARK (T MARK).
- 4** Press ENTER (ENTER) again.  
"TOC Edit" flashes in the display, and all the tracks will be erased.  
When erasing is complete, "BLANKDISC" appears in the display.

#### Adding a track mark

You can add track marks so that the part after the new track mark is counted as a new track.

The track numbers will increase as follows.

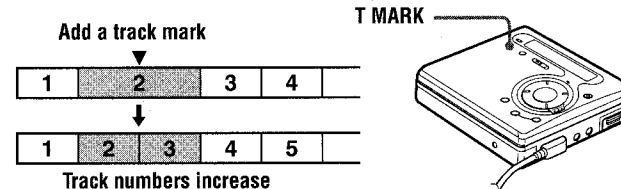

- 1** While playing or pausing an MD, press T MARK on the recorder at the point you want to mark.  
"MARK ON" appears in the display, and a track mark is added.  
The track number will increase by one.

#### To add track marks while recording

Press T MARK on the recorder at the point you want to add a track mark.

### Notes

- You cannot add track marks during synchro-recording.
- T MARK on the remote control does not function during playback.

---

## Erasing a track mark

When you record with analog (line) input, unnecessary track marks may be recorded where recording level is low. You can erase a track mark to combine the tracks before and after the track mark. The track numbers will change as follows.

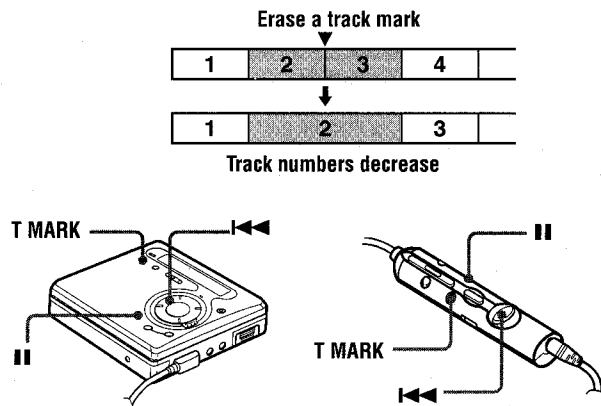

- 1** While playing the track with the track mark you want to erase, press **II** to pause.
- 2** Find the track mark by pressing **II** slightly.  
For example, to erase the third track mark, find the beginning of the third track. "00:00" appears in the display.  
"MARK" appears in the display for 2 seconds.

- 3** Press T MARK to erase the mark.  
"MARK OFF" appears in the display. The track mark is erased and the two tracks are combined.



When you erase a track mark, name assigned to the mark is also erased.

---

## Moving recorded tracks

You can change the order of the recorded tracks.

### Example

Move track C from the third to the second track.

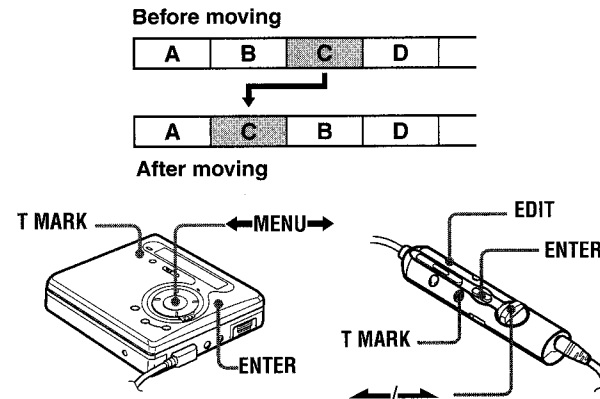

- 1** While playing the track you want to move, press ENTER (EDIT for 2 seconds or more).

continued

- 2 Press **←MENU→** (flip the lever towards **←** or **→**) repeatedly until "EDIT" flashes in the display, and then press ENTER (ENTER) again.  
"🎵: Name" flashes in the display and the recorder plays the selected track repeatedly.
- 3 Press **←MENU→** (flip the lever towards **←** or **→**) repeatedly until "🎵: Move" flashes in the display, and then press ENTER (ENTER).  
For the example above, "MV 003 → 003" appears in the display.
- 4 Press **←MENU→** (flip the lever towards **←** or **→**) to select the destination track number.  
For the example above, "MV 003 → 002" appears in the display.  
To cancel moving, press T MARK (T MARK).
- 5 Press ENTER (ENTER) again.  
The track moves to the selected destination track.

## Labeling recordings

You can name discs while the recorder is stopped, tracks while the recorder is playing, and both while the recorder is recording. Each name can be as long as 200 letters.  
Each disc can hold up to 1700 alphanumeric letters during playback or stop.

### Available characters

- Capital and small letters of the English alphabet
- Numbers 0 to 9
- ! " # \$ % & ( ) \* . : ; < = > ? @ \_ ` + - ' , / : \_ (space)

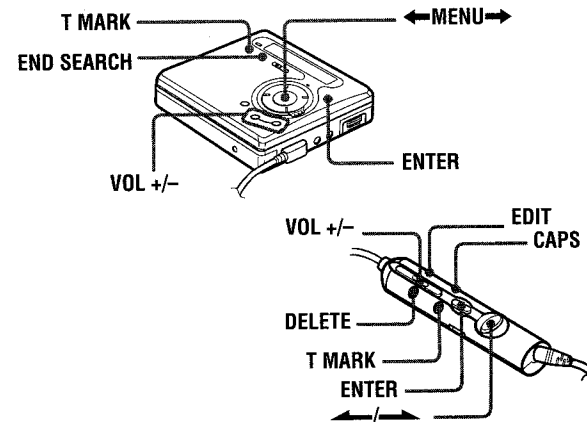

### Labeling a disc during stop

- 1 Press ENTER (EDIT for 2 seconds or more), press **←MENU→** (flip the lever towards **←** or **→**) repeatedly until "EDIT" flashes in the display, and then press ENTER (ENTER) again.  
"🎵: Name" flashes in the display.

**continued**



- 2** Press ENTER (ENTER).  
The disc is ready to be labeled.

- 3** Press ◀MENU▶ (flip the lever towards ◀ or ▶) repeatedly to select a letter and press ENTER (ENTER).  
The selected letter stops flashing and the cursor moves to the next input position.

Press	To
II (CAPS)	Switch between capital letters, small letters and marks / numbers.
VOL +/- (VOL +/-)	Move the cursor to the left or right.
◀MENU▶ (◀ or ▶)	Change the letter to the one before / next one.
END SEARCH/VOL + (EDIT)	Insert a blank space to type in a new letter pressing both buttons together.
END SEARCH/VOL - (DELETE)	Delete a letter and move back all following letters to the left pressing both buttons together.
T MARK (T MARK)	Cancel labeling.

- 4** Repeat step 3 and enter all characters of the label name.  
To cancel labeling, press T MARK (T MARK).
- 5** Press ENTER (ENTER) for 2 seconds or more.  
The track or disc is labeled.

### Labeling a track during playback

- 1** Insert a disc and play the track you want to label.
- 2** Press ENTER (EDIT for 2 seconds or more), press ◀MENU▶ (flip the lever towards ◀ or ▶) repeatedly until "EDIT" flashes in the display, and then press ENTER (ENTER) again.  
"♪: Name" flashes in the display.
- 3** Press ENTER (ENTER).  
The track is ready to be labeled.

48

- 4** Follow steps 3 to 5 of "Labeling a disc during stop".

### Labeling a track or a disc during recording

- 1** While recording, press ENTER (EDIT for 2 seconds or more).
- 2** Press ◀MENU▶ (flip the lever towards ◀ or ▶) repeatedly until "EDIT" flashes in the display, and then press ENTER (ENTER) again.  
"♪: Name" flashes in the display.
- 3** To label a track, press ENTER (ENTER) again.  
To label a disc, press ◀MENU▶ (flip the lever towards ◀ or ▶) repeatedly until "Ⓢ: Name" flashes in the display, then press ENTER (ENTER).  
The track or disc is ready to be labeled.
- 4** Follow steps 3 to 5 of "Labeling a disc during stop".

### To cancel labeling

Press T MARK (T MARK).

### Notes

- When the recording is stopped while labeling a track or a disc during recording, or when the recording moves on to the next track while labeling a track, the input at that point is entered automatically.
- "LP:" is automatically added at the beginning of track names for tracks recorded in LP2 or LP4 mode.

### Relabeling recordings

Follow the steps corresponding to the labeling method until the disc or track is ready to be labeled. Enter a new character over the one you want to change, then press ENTER (ENTER) for 2 seconds or more.

### Notes

- You cannot relabel premastered MDs or label MDs that have not been recorded.
- The recorder is able to display, but cannot label using Japanese "Katakana" characters.
- The recorder cannot rewrite a disc or track name of more than 200 letters that was created by another device.

49

## Power sources

You can use the recorder on house current or as follows.

In the recorder ...

- a Nickel Cadmium rechargeable battery NC-WMAA (supplied)
- an LR6 (size AA) alkaline dry battery (not supplied)

It is preferable to use the recorder on house current when recording for a long time.

## Battery life<sup>1)</sup>

(Unit: approx.hours) (JEITA<sup>2)</sup>)

Batteries		Stereo	LP2	LP4
NC-WMAA Nickel Cadmium rechargeable battery <sup>3)</sup>	Recording	4	6	7.5
	Playback	13	14.5	18
LR6 (SG) Sony alkaline dry battery <sup>4)</sup>	Recording	9	13	16
	Playback	40	46	53

<sup>1)</sup> The battery life may be shorter due to operating conditions, the temperature of the location, and varieties of batteries.

<sup>2)</sup> Measured value by the standard of JEITA (Japan Electronics and Information Technology Industries Association).

<sup>3)</sup> When using a 100% fully charged rechargeable battery.

<sup>4)</sup> When using a Sony LR6 (SG) "STAMINA" alkaline dry battery (produced in Japan).

## When to replace the battery

When the dry battery or rechargeable battery is weak, flashing , "LOW BATT," etc. appears in the display. Replace the dry battery or charge the rechargeable battery.

Note that the battery level indicated by the battery indication is only approximate and varies with the recorder condition.

### Note

Stop the recorder before replacing battery.

## Additional information

## Precautions

### On safety

Do not put any foreign objects in the DC IN 3V jack.

### On power sources

- Use house current, Nickel Cadmium rechargeable battery, LR6 (size AA) battery, or car battery.
- For use in your house: Use the AC power adaptor supplied with this recorder. Do not use any other AC power adaptor since it may cause the recorder to malfunction.

### Polarity of the plug



- The recorder is not disconnected from the AC power source (mains) as long as it is connected to the wall outlet, even if the recorder itself has been turned off.
- If you are not going to use this recorder for a long time, be sure to disconnect the power supply (AC power adaptor, dry battery, rechargeable battery, or car battery cord). To remove the AC power adaptor from the wall outlet, grasp the adaptor plug itself; never pull the cord.

### On heat build-up

Heat may build up in the recorder if it is used for an extended period of time. In this case, leave the recorder turned off until it cools down.

### On installation

- Never use the recorder where it will be subjected to extremes of light, temperature, moisture or vibration.
- Never wrap the recorder in anything when it is being used with the AC power adaptor. Heat build-up in the recorder may cause malfunction or damage.

## On the headphones/earphones

### Road safety

Do not use headphones/earphones while driving, cycling, or operating any motorized vehicle. It may create a traffic hazard and is illegal in many areas. It can also be potentially dangerous to play your recorder at high volume while walking, especially at pedestrian crossings. You should exercise extreme caution or discontinue use in potentially hazardous situations.

### Preventing hearing damage

Avoid using headphones/earphones at high volume. Hearing experts advise against continuous, loud and extended play. If you experience a ringing in your ears, reduce the volume or discontinue use.

### Caring for others

Keep the volume at a moderate level. This will allow you to hear outside sounds and to be considerate of the people around you.

## On the MiniDisc cartridge

- When carrying or storing the MiniDisc, keep it in its case.
- Do not break open the shutter.
- Do not place the cartridge where it will be subject to light, extreme temperatures, moisture or dust.
- Attach the supplied MD label only in the space designated for it on the disc. Do not stick it on any other disc surface.

## On cleaning

- Clean the recorder casing with a soft cloth slightly moistened with water or a mild detergent solution. Do not use any type of abrasive pad, scouring powder or solvent such as alcohol or benzene as it may mar the finish of the casing.
- Wipe the disc cartridge with a dry cloth to remove dirt.
- Dust on the lens may prevent the unit from operating properly. Be sure to close the disc compartment lid after inserting or ejecting an MD.
- To obtain the best sound quality, use a dry cloth to wipe the plugs of the headphones/earphones or the remote control. Dirty plugs may cause sound distortion or intermittent breaks in the sound.

## Notes on batteries

Incorrect battery usage may lead to leakage of battery fluid or bursting batteries. To prevent such accidents, observe the following precautions:

- Install the + and – poles of the batteries correctly.
- Do not try to recharge dry battery.
- When the recorder is not to be used for a long time, be sure to remove the batteries.
- If a battery leak should develop, carefully and thoroughly wipe away battery fluid from the battery compartment before inserting new ones.

## On the lid of the battery compartment

The lid of the battery compartment is designed to detach from the main unit when handled with great force. To reattach the lid to the main unit, follow the steps below:

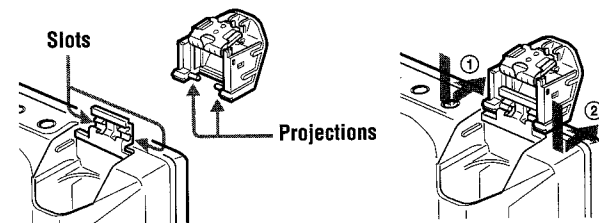

1 Place the lid so that the projections on the lid aligned with the slots on the main unit.

2 Fit the projection one by one into the slot as shown in the illustration.

## Note on mechanical noise

The recorder gives off mechanical noise while operating, which is caused by the power-saving system of the recorder and it is not a problem.

---

## Troubleshooting

Should any problem persist after you have made these checks, consult your nearest Sony dealer.

### The recorder does not work or works poorly.

- Audio sources may not be firmly connected.
  - Disconnect the audio sources once and connect them again (pages 14, 23).
- The HOLD function is turned on (“HOLD” appears in the display when you press an operation button on the recorder).
  - Disable HOLD by moving the HOLD switch in the opposite direction of the arrow (pages 12, 38).
- Moisture has condensed inside the recorder.
  - Take the MD out and leave the recorder in a warm place with the lid open for several hours until the moisture evaporates.
- The rechargeable battery or dry battery is weak (☐ or “LOW BATT” flashes).
  - Charge the rechargeable battery or replace the dry battery (page 50).
- The rechargeable battery or dry battery have been inserted incorrectly.
  - Insert the battery correctly (page 11).
- You pressed a button while the disc indication was rotating quickly.
  - Wait until the indication rotates slowly.
- The analog recording was made using a connecting cord with an attenuator.
  - Use a connecting cord without an attenuator (page 23).
- While operating, the recorder received a mechanical shock, too much static, abnormal power voltage caused by lightning, etc.
  - Restart the operation as follows.
    - 1 Disconnect all the power sources.
    - 2 Leave the recorder for about 30 seconds.
    - 3 Connect the power source.
- The disc is damaged or does not contain proper recording or editing data.
  - Reinsert the disc. If this fails, rerecord.

### “NO SIGNAL” appears in the display when recording from a portable CD player.

- There is no digital signal from the portable CD player.
  - When recording digitally from a portable CD player, use AC power adaptor and disable the anti-skip function (such as ESP) on the CD player (page 16).

### There is no recording after a recording operation.

- The AC power adaptor was unplugged or a power outage occurred during recording.

### The lid does not open.

- The power sources have been disconnected during recording or editing, or the battery have been exhausted.
  - Set the power sources again, or replace the exhausted battery with new ones.

### No sound comes through the headphones/earphones.

- The headphones/earphones plug is not firmly connected.
  - Plug in the plug of the headphones/earphones firmly to the remote control. Plug in the plug of the remote control firmly to .
- Volume is too low.
  - Adjust the volume by pressing VOL +/-.

### Volume cannot be turned up.

- AVLS is on.
  - Set AVLS to “AVLS OFF” (page 37).

### An MD is not played from the first track.

- Disc playing stopped before it came to the last track.
  - Press  repeatedly to go back to the beginning of the disc, and restart playing after checking the track number in the display.

### Playback sound skips.

- The recorder is placed where it receives continuous vibration.
  - Put the recorder on a stable place.
- A very short track may cause sound to skip.

### Sound has a lot of static.

- Strong magnetism from a television or such device is interfering with operation.
  - Move the recorder away from the source of strong magnetism.

**Cannot find the track marks.**

- You pressed **II** after pressing **I◀◀** or **▶▶I**.  
— Press **II** before or pressing **I◀◀** or **▶▶I** (page 44).

**The rechargeable battery does not start charging.**

- The rechargeable battery has been inserted incorrectly or the AC power adaptor has been connected incorrectly.  
— Insert the battery correctly or connect the AC power adaptor correctly.

**Momentary noise is heard.**

- Due to the special digital audio compression technology used in LP4 mode, momentary noise may occur on very rare occasions with certain sound sources.  
— Record in normal stereo or LP2 mode.

**System limitations**

The recording system in your MiniDisc recorder is radically different from those used in cassette and DAT decks and is characterized by the limitations described below. Note, however, that these limitations are due to the inherent nature of the MD recording system itself and not to mechanical causes.

Symptom	Cause
“TR FULL” appears even before the disc has reached the maximum recording time (60, 74, or 80 minutes).	When 254 tracks have been recorded on the disc, “TR FULL” appears regardless of the total recorded time. More than 254 tracks cannot be recorded on the disc. To continue recording, erase unnecessary tracks.
“TR FULL” appears even before the disc has reached the maximum track number or recording time.	Repeated recording and erasing may cause fragmentation and scattering of data. Although those scattered data can be read, each fragment is counted as a track. In this case, the number of tracks may reach 254 and further recording is not possible. To continue recording, erase unnecessary tracks.

Symptom	Cause
Track marks cannot be erased. The remaining recording time does not increase even after erasing numerous short tracks.	When the data of a track is fragmented, the track mark of a fragment under 12 seconds long (recorded in stereo), 24 seconds long (recorded in monaural or LP2 mode), or 48 seconds long (recorded in LP4 mode) cannot be erased. You cannot combine a track recorded in different recording mode, e.g., a track recorded in stereo and a track recorded in monaural; nor can you combine a track recorded with digital connection and a track recorded with analog connection. Tracks of under 12 seconds, 24 seconds, or 48 seconds in length are not counted and so erasing them may not lead to an increase in the recording time.
The total recorded time and the remaining time on the disc may not total the maximum recording time (60, 74, or 80 minutes).	Normally, recording is done in minimum units of approximately 2 seconds (in stereo), 4 seconds (in monaural or LP2 mode), or 8 seconds (in LP4 mode). When recording is stopped, the last unit of recording always uses this unit of 2 seconds, 4 seconds, or 8 seconds even if the actual recording is shorter. Likewise, when recording is restarted after the stop, the recorder will automatically insert a blank space amounting to 2 seconds, 4 seconds, or 8 seconds before the next recording. (This is to prevent accidental erasing of a previous track whenever a new recording is started). Therefore, the actual recording time will decrease whenever a recording is stopped by a maximum of 6 seconds, 12 seconds, or 24 seconds.
The edited tracks may exhibit sound dropout during search operations.	The fragmentation of data may cause sound dropout while searching because the tracks are played in higher speed than normal playback.

---

## Messages

If the following messages flash in the display window, check the messages below.

### BLANKDISC

- An MD with no recording on it is inserted.

### DISC ERR

- The disc is damaged or does not contain proper recording or editing data.
  - Reinsert the disc. If this fails, rerecord.

### DISC FULL

- There is no more space to record on the disc.
  - Replace the disc.

### Data Save

- The MD player is recording information (sounds) from the memory to the disc.
  - Wait until this process is completed. Do not expose the player to any physical shock, nor disrupt power supply.

### TOC Edit

- The MD player is recording information (track start and end position) from the memory to the disc.
  - Wait until this process is completed. Do not expose the player to physical shock, nor disrupt power supply.

### BUSY

- You tried to operate the recorder while it was accessing the recorded data.
  - Wait until the message goes out (in rare cases, it may take 2 - 3 minutes).

### NAME FULL

- You tried to enter more than 200 letters to label a single track or disc.
- You tried to enter a total of more than 1700 letters for track or disc names.
  - Enter the characters within the limit.

### Hi DC in

- Voltage of the power supply is too high (The supplied AC power adaptor is not used).
  - Use the supplied AC power adaptor.

### HOLD

- The recorder is locked.
  - Move HOLD against the arrow to unlock the recorder (pages 12, 38).

### LOW BATT

- Battery is weak.
  - Charge the rechargeable battery or replace the dry battery (page 11).

### MEM OVER

- You tried to record with the recorder placed where it receives continuous vibration.
  - Put the recorder on a stable place, and start recording again.

### NO COPY

- You tried to make a copy from a disc that is protected by the Serial Copy Management System. You cannot make copies from a digitally connected source which was itself recorded using digital connection.
  - Use analog connection instead (page 23).

### NO DISC

- You tried to play or record with no disc in the recorder.
  - Insert an MD.

### NO SIGNAL

- The recorder could not detect digital input signals.
  - Make sure that the source is connected firmly (page 14).

### P/B ONLY

- You tried to record or edit on a premastered MD (P/B stands for "playback").
  - Insert a recordable MD.

### PROTECTED

- You tried to record or edit on a MD with the tab in the record-protect position.
  - Slide the tab back (page 54).

## **SORRY**

- You tried to erase the track mark at the beginning of the first track.
- You tried to erase a track mark to combine tracks the recorder cannot combine (a track recorded in different recording mode, or a track recorded through a digital connection and an analog connection, for example).
- You tried to press **II**, T MARK, or REC MODE during synchro-recording.

## **TEMP OVER**

- Heat has built up in the recorder.  
— Let the recorder cool down.

## **TR FULL**

- There is no more space for new data when you are editing the MD.  
- Erase unnecessary tracks (page 41).

## **TrPROTECT**

- You tried to record or edit on a track that is protected from erasing.  
— Record or edit on other tracks.

## **Specifications**

### **MD Recorder**

#### **Audio playing system**

MiniDisc digital audio system

#### **Laser diode properties**

Material: GaAlAs MQW

Wavelength:  $\lambda = 790 \text{ nm}$

Emission duration: continuous

Laser output: less than  $44.6 \mu\text{W}$

(This output is the value measured at a distance of 200 mm from the lens surface on the optical pick-up block with 7 mm aperture.)

#### **Recording and playback time**

When using MDW-80

Maximum 160 min. in monaural

Maximum 320 min. in stereo

#### **Revolutions**

350 rpm to 2,800 rpm (CLV)

#### **Error correction**

ACIRC (Advanced Cross Interleave

Reed Solomon Code)

#### **Sampling frequency**

44.1 kHz

#### **Sampling rate converter**

Input: 32 kHz/44.1 kHz/48 kHz

#### **Coding**

ATRAC (Adaptive TRansform

Acoustic Coding)

ATRAC3 — LP2

ATRAC3 — LP4

#### **Modulation system**

EFM (Eight to Fourteen

Modulation)

#### **Number of channels**

2 stereo channels

1 monaural channel

#### **Frequency response**

20 to 20,000 Hz  $\pm 3 \text{ dB}$

#### **Wow and Flutter**

Below measurable limit

### **Inputs**

Microphone: stereo mini-jack,

minimum input level 0.35 mV

Line in: stereo mini-jack, minimum

input level 49 mV

Optical (Digital) in: optical (digital)

mini-jack

### **Outputs**

⌋: stereo mini-jack, maximum

output level 5 mW + 5 mW, load

impedance 16 ohm

### **General**

#### **Power requirements**

Sony AC Power Adaptor (supplied)

connected at the DC IN 3 V jack:

120 V AC, 60 Hz (U.S.A.,

Canadian and Taiwan model)

230 V AC, 50/60 Hz (Europe

continental model)

240 V AC, 50 Hz (Australian

model)

220 V AC, 50 Hz (Chinese

model)

230 - 240 V AC, 50 Hz (U.K. and

Hong Kong model)

220 V AC, 50 Hz (Argentina

model)

110/220 V AC, 60 Hz (Korean

model)

100 - 240 V AC, 50/60 Hz (Other

models)

Nickel Cadmium rechargeable

battery NC-WMAA (supplied)

LR6 (size AA) alkaline battery (not

supplied)

#### **Battery operation time**

See "Battery life" (page 50)

### Quick Random Access

Like CDs, MDs offer instantaneous random access to the beginning of any music track. Premastered MDs are recorded with location addresses corresponding to each music selection.

Recordable MDs are manufactured with a "User TOC Area" to contain the order of the music. The TOC (Table of Contents) system is similar to the

"directory management system" of floppy disks. In other words, starting and ending addresses for all music tracks recorded on the disc are stored in this area. This lets you randomly access the beginning of any track as soon as you enter the track number (AMS), as well as label the location with a track name as you would a file on a diskette.

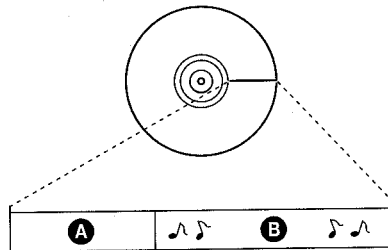

- A** — User TOC Area  
Contains the order and start/end points of the music.
- B** — Music Data