

Compact Disc MiniDisc Deck

Operating Instructions



*MXD-D40
MXD-D4*

WARNING

To prevent fire or shock hazard, do not expose the unit to rain or moisture.

To avoid electrical shock, do not open the cabinet. Refer servicing to qualified personnel only.

The laser component in this product is capable of emitting radiation exceeding the limit for Class 1.

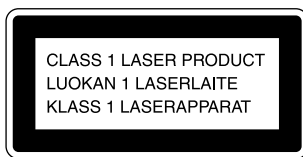

This appliance is classified as a CLASS 1 LASER product. The CLASS 1 LASER PRODUCT MARKING is located on the rear exterior.

To prevent fire, do not cover the ventilation of the apparatus with news papers, table-cloths, curtains, etc. And don't place lighted candles on the apparatus.

To prevent fire or shock hazard, do not place vases on the apparatus.

The following caution label is located inside of the unit.

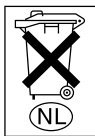

Don't throw a battery, dispose it as the injurious wastes.

IN NO EVENT SHALL SELLER BE LIABLE FOR ANY DIRECT, INCIDENTAL OR CONSEQUENTIAL DAMAGES OF ANY NATURE, OR LOSSES OR EXPENSES RESULTING FROM ANY DEFECTIVE PRODUCT OR THE USE OF ANY PRODUCT.

CAUTION

The use of optical instruments with this product will increase eye hazard.

For the customers in the U.S.A.

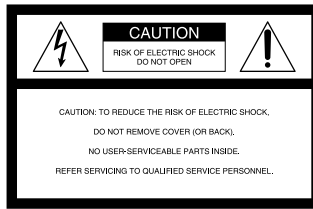

This symbol is intended to alert the user to the presence of uninsulated "dangerous voltage" within the product's enclosure that may be of sufficient magnitude to constitute a risk of electric shock to persons.



This symbol is intended to alert the user to the presence of important operating and maintenance (servicing) instructions in the literature accompanying the appliance.

CAUTION

You are cautioned that any changes or modification not expressly approved in this manual could void your authority to operate this equipment.

INFORMATION

This equipment has been tested and found to comply with the limits for a Class B digital device, pursuant to Part 15 of the FCC Rules. These limits are designed to provide reasonable protection against harmful interference in a residential installation. This equipment generates, uses, and can radiate radio frequency energy and, if not installed and used in accordance with the instructions, may cause harmful interference to radio communications. However, there is no guarantee that interference will not occur in a particular installation. If this equipment does cause harmful interference to radio or television reception, which can be determined by turning the equipment off and on, the user is encouraged to try to correct the interference by one or more of the following measures:

- Reorient or relocate the receiving antenna.
- Increase the separation between the equipment and receiver.
- Connect the equipment into an outlet on a circuit different from that to which the receiver is connected.
- Consult the dealer or an experienced radio/TV technician for help.

Owner's Record

The model and serial numbers are located on the rear of the unit. Record the serial number in the space provided below. Refer to them whenever you call upon your Sony dealer regarding this product.

Model No. MXD-D40/MXD-D4
Serial No. _____



ENERGY STAR® is a U.S. registered mark.

As an ENERGY STAR® Partner, Sony Corporation has determined that this product meets the ENERGY STAR® guidelines for energy efficiency.

For the customers in Canada

This Class B digital apparatus complies With Canadian ICES-003.

CAUTION

TO PREVENT ELECTRIC SHOCK, DO NOT USE THIS POLARIZED AC PLUG WITH AN EXTENSION CORD, RECEPTACLE OR OTHER OUTLET UNLESS THE BLADES CAN BE FULLY INSERTED TO PREVENT BLADE EXPOSURE.

About This Manual

The instructions in this manual are for models MXD-D40 and MXD-D4. The MXD-D40 is the model used for illustration purposes. Any difference in operation is clearly indicated in the text, for example, "MXD-D40 only".

Conventions

- Before operating the deck, connect your deck by referring to "Getting Started."
- For basic operations, see "Playing a CD," "Playing an MD," "Recording a CD to an MD" and "Recording a CD to an MD at High Speed."
- Controls in the instructions are those on the deck; these may, however, be substituted by controls on the remote that are similarly named or, when different, appear in the instructions within brackets.
- The following icons are used in this manual:



Indicates a procedure that requires use of the remote.



Indicates tips for making the task easier and hints.

TABLE OF CONTENTS

Getting Started

Unpacking	4
Hooking Up the System	4

Playing a CD	6
--------------------	---

Playing an MD	7
---------------------	---

Recording a CD to an MD (CD-MD Synchro-Recording)	8
--	---

Recording a CD to an MD at High Speed (High-Speed CD-MD Synchro-Recording) ...	10
---	----

Playing CDs and MDs

Using the Display	12
Locating a Specific Track	14
Locating a Particular Point in a Track	15
Playing Tracks Repeatedly (Repeat Play)	15
Playing in Random Order (Shuffle Play)	16
Creating Your Own Program (Program Play)	16
Falling Asleep to Music (Sleep Timer)	17
Changing the Pitch of the MD (Pitch Control Function)	18

Recording on MDs

Notes on Recording	19
Useful Tips for Recording	20
Recording on an MD Manually	21
Recording for Long Times	22
Adjusting the Recording Level	23
Marking Track Numbers While Recording	24
Recording the Current CD Track (REC-IT Function)	25
Synchro-Recording With an External Audio Equipment (Music Synchro-Recording)	26
Starting Recording With Prestored Audio Data (Time Machine Recording)	26
Fading In and Out (Fader)	27

Editing Recorded MDs

Notes on Editing	28
Erasing Recordings	28
Erasing a Part of a Track (A-B Erase Function)	29
Dividing Recorded Tracks (Divide Function)	30
Combining Recorded Tracks (Combine Function) ...	31
Moving Recorded Tracks (Move Function)	32
Labeling Recordings (Name Function)	33
Undoing the Last Edit (Undo Function)	37
Changing the Recorded Level After Recording (S.F Edit Function)	38

Additional Information

Precautions	40
Display Messages	41
System Limitations	42
Troubleshooting	43
Specifications	44
Guide to the Serial Copy Management System	45
Index	47
Table of Setup Menus	49
Self-Diagnosis Function	50
Notes on CDs	51
Handling MDs	51

Unpacking

Check that you received the following items:

- Audio connecting cords (2)
- Remote commander (remote) (1)
- Sony R6 (size-AA) batteries (2)
- Power plug adaptor (1) (Singaporean model only)

Inserting batteries into the remote

You can control the deck using the supplied remote. Insert two R6 (size-AA) batteries by matching the + and - on the batteries. When using the remote, point it at the remote sensor  on the deck.

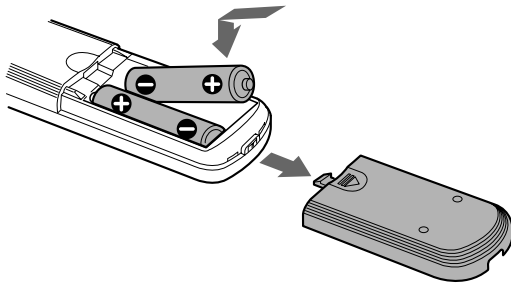

D.SKIP on the remote cannot be used with this deck.

When to replace batteries

With normal use, the batteries should last for about six months. When the remote no longer operates the deck, replace all the batteries with new ones.

Notes

- Do not leave the remote near an extremely hot or humid place.
- Do not drop any foreign object into the remote casing, particularly when replacing the batteries.
- Do not expose the remote sensor to direct sunlight or lighting apparatuses. Doing so may cause a malfunction.
- If you don't use the remote for an extended period of time, remove the batteries to avoid possible damage from battery leakage and corrosion.

Hooking Up the System

Overview

This section describes how to hook up the deck to an amplifier or other components such as a CD player or DAT deck. Be sure to turn off the power of each component before connection.

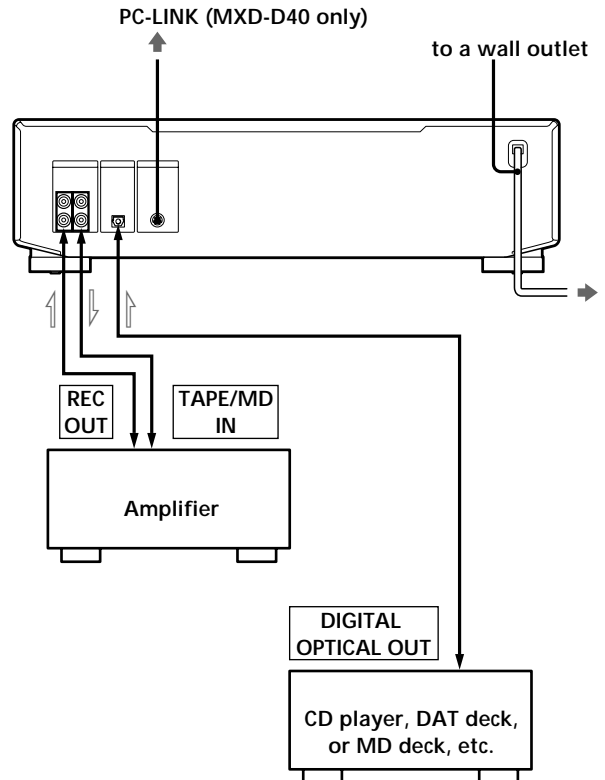

: Signal flow

What cords will I need?

- Audio connecting cords (supplied) (2)

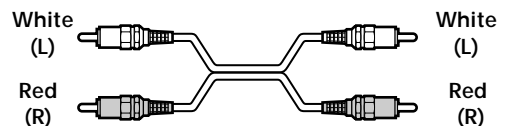

- Optical cable (not supplied) (1)

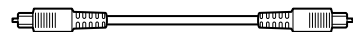

Hookups

Connecting the deck to an amplifier

Connect the amplifier to the ANALOG IN/OUT jacks using the audio connecting cords (supplied), making sure to match the color-coded cords to the appropriate jacks on the components: red (right) to red and white (left) to white. Be sure to make connections firmly to prevent hum and noise.

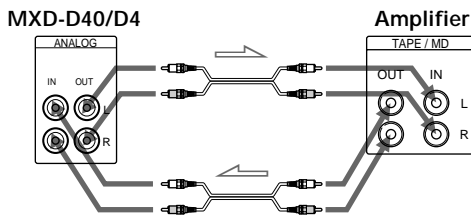

⇒: Signal flow

Connecting the deck to a digital component such as a CD player, DAT deck, or an MD deck

Connect the component through the DIGITAL OPTICAL IN connector with the optical cable (not supplied).

Take the caps off the connectors and then insert the plugs parallelly until they click into place. Be sure not to bend or tie the optical cable.

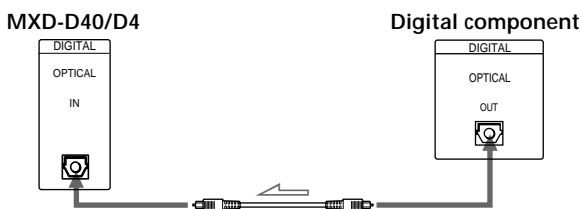

⇒: Signal flow

💡 If “Din Unlock” and “C71” alternate in the display
The optical cable is not connected properly. Check that the connections are secure.

Automatic conversion of digital sampling rates during recording

A built-in sampling rate converter automatically converts the sampling frequency of various digital sources to the 44.1 kHz sampling rate of this deck. This allows you to record sources such as 32- and 48-kHz DAT or satellite broadcasts, as well as compact discs and MDs.

Note

If “Din Unlock” or “Cannot Copy” flashes in the display, recording through the DIGITAL OPTICAL IN connector is not possible. In this case, record the program source through the ANALOG IN jacks with “ANALOG” selected by INPUT.

Setting the voltage selector (only on models supplied with a voltage selector)

Check that the voltage selector on the rear panel of the deck is set to the local power line voltage. If not, set the selector to the correct position using a screwdriver before connecting the AC power cord to an AC outlet.

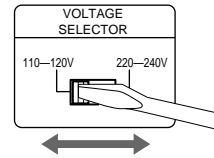

Connecting the AC power cord

Connect the AC power cord to a wall outlet.

Note

Do not connect the AC power cord to a switched outlet.

Connecting a PC (MXD-D40 only)

Use the PCLK-MN10A PC connecting kit (not supplied) to connect a PC to the deck. By connecting the deck to a PC, you will be able to select and play MD tracks and do various MD editing operations on the PC. For details, refer to the manual supplied with the PC connecting kit.

Demonstration mode

When you turn on the deck and there is no CD or MD in the deck, demonstration mode is activated automatically after about ten minutes. To deactivate the demonstration mode, press any button on the deck or on the remote.

💡 To turn off the demonstration mode

Press ■ on the left of the front panel and CLEAR on the right of the front panel simultaneously. Demonstration mode is turned off until you unplug the power cord of the deck and plug it in again.

Playing a CD

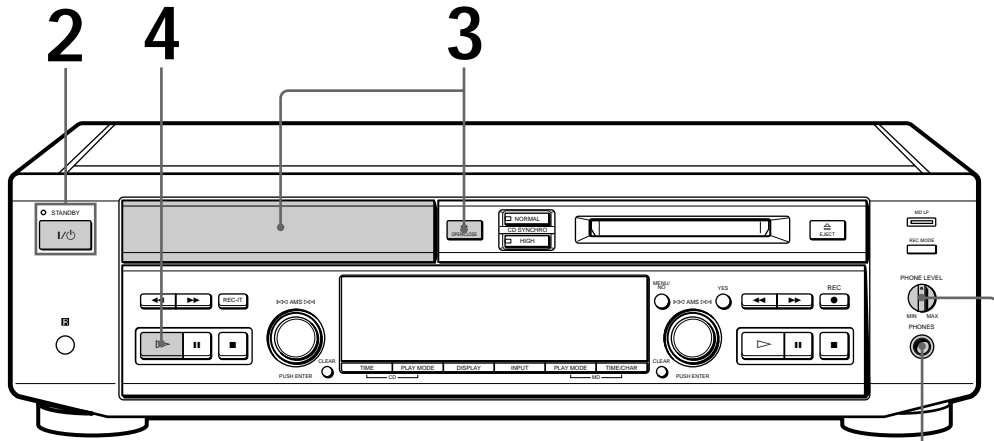





Connect the headphones.

Adjust the headphone volume.



When using the controls on the deck
Use the CD player controls located to the left of the front panel.

When using the remote 
Set SELECT to CD.

Audio output
Output switches automatically to the audio of the CD.

-  You can start playing with the track selected in step 4
- 1 Turn AMS (or press  or ) to select the track you want to play using the display*.
- 2 Press AMS or .





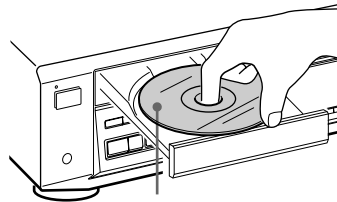

* See "Using the Display" on page 12.

- 1** Turn on the amplifier and set the source selector to the position for this deck.
- 2** Press .
The STANDBY indicator turns off.
- 3** Press  OPEN/CLOSE to insert a CD. Press the button again to close the CD tray.
When you play an 8-cm CD, place it on the inner circle of the tray.



With the label side up

- 4** Press .
The deck starts playing. Adjust the volume on the amplifier.

To	Do the following:
Stop playing	Press  .
Pause playing	Press  . Press the button again or press  to resume playing.
Go to the next track	Turn AMS clockwise (or press  on the remote).
Go to the beginning of the current track or the preceding track	Turn AMS counterclockwise (or press  on the remote).
Take out the CD	Press  OPEN/CLOSE after stopping playing.

Playing an MD

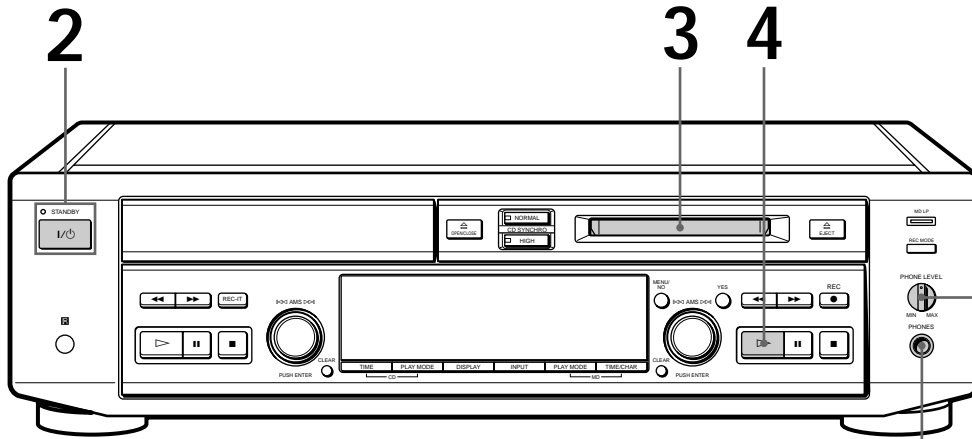

Connect the headphones.

Adjust the headphone volume.

When using the controls on the deck
Use the MD deck controls located to the right of the front panel.

When using the remote
Set SELECT to MD.

Audio output
Output switches automatically to the audio of the MD.

You can start playing with the track selected in step 4
1 Turn AMS (or press **◀◀** or **▶▶**) to select the track you want to play using the display*.
2 Press AMS or **▷**.

* See "Using the Display" on page 12 and 13.

You can change the MD playback speed
See "Changing the Pitch of the MD" on page 18.

- 1** Turn on the amplifier and set the source selector to the position for this deck.
- 2** Press **I/⏻**.
The STANDBY indicator turns off.

- 3** Insert an MD.

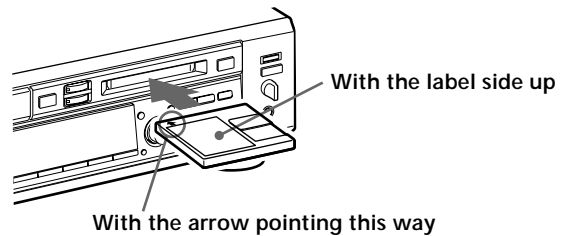

- 4** Press **▷**.
The deck starts playing. Adjust the volume on the amplifier.

To	Do the following:
Stop playing	Press ■ .
Pause playing	Press ⏸ . Press the button again or press ▷ to resume playing.
Go to the next track	Turn AMS clockwise (or press ▶▶ on the remote).
Go to the beginning of the current track or the preceding track	Turn AMS counterclockwise (or press ◀◀ on the remote).
Take out the MD	Press ⏏ EJECT after stopping playing.

Recording a CD to an MD (CD-MD Synchro-Recording)

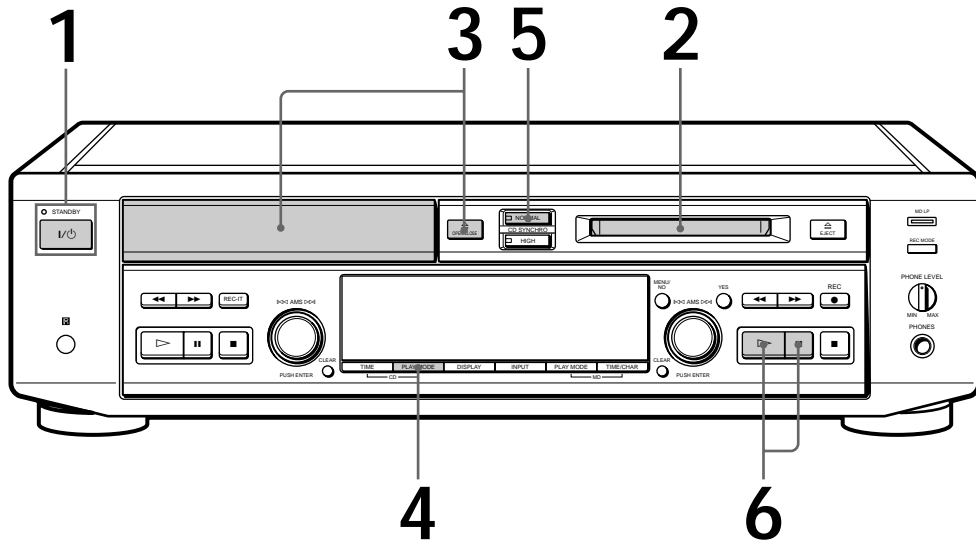

You can easily make digital recordings from a CD to an MD, marking track numbers in the same sequence as the original CD.

Before recording, see “Notes on Recording” on page 19.



 CD text is copied to the MD automatically

When the CD to be recorded using the CD-MD Synchro-Recording Function contains track names, this information is recorded onto the MD automatically.

Note that CD text on some CDs is copy-protected and thus may not be copied to the MD.

 You can play back tracks just recorded

If “TRACK” lights up in the display when recording has finished, press  immediately to play back from the first track of the material just recorded.

- 1** Press I/⏻.
The STANDBY indicator turns off.
- 2** Insert a recordable MD.
- 3** Press  OPEN/CLOSE to insert a CD. Press the button again to close the CD tray.
- 4** Press PLAY MODE to select the playing mode of the CD (normal play or Program Play).
- 5** Press CD SYNCHRO NORMAL.
“CD SYNCHRO” appears and “-Normal-” flashes in the display.
The MD deck section stands by for recording, and the CD player section stands by for playing.
- 6** After “CD SYNCHRO” and “-Normal-” turn off, press  or  on the right of the front panel.
Recording starts. The MD deck section and the CD player section will automatically stop after recording.

To stop recording

Press  on the right of the front panel.

Notes

- You cannot record over existing material. The deck automatically starts recording from the end of the existing material.
- Make sure that the remaining recordable time on the MD is longer than the playing time of the CD, especially if you want to record all the tracks on the CD.
- You cannot pause recording.
- If the play mode is set to Repeat Play or Shuffle Play, it automatically switches to normal play at step 5.
- The recording level specified in the Setup Menu (page 23) is not applied. The initial reference level (0.0 dB) is used instead.

When "TOC Writing" flashes in the display

The deck is currently updating the Table Of Contents (TOC). Do not move the deck or pull out the AC power cord. Changes to an MD made through recording are saved only when you update the TOC by ejecting the MD or turning off the deck.

Do not disconnect the deck from the power source immediately after recording

If you do, recorded material may not be saved to the MD. To save the material, after recording, press \cong EJECT to take out the MD or turn off the deck. "TOC Writing" will flash at this time.

After "TOC Writing" goes out, you can pull out the AC power cord.

To protect an MD against accidental erasure

To make it impossible to record on an MD, slide the tab in the direction of arrow, opening the slot. To allow recording, close the slot.

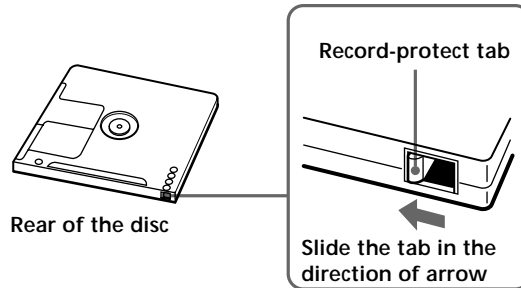



Recording a CD to an MD at High Speed

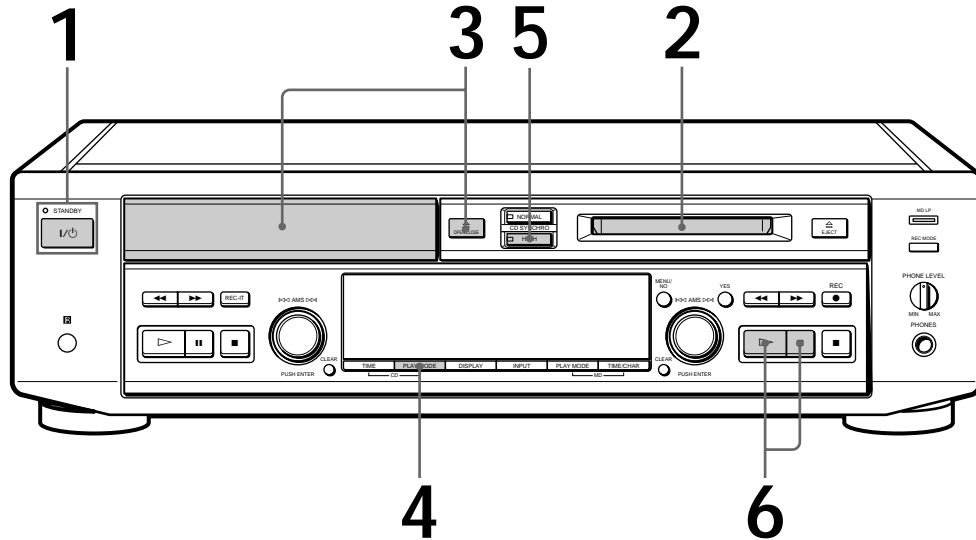

(High-Speed CD-MD Synchro-Recording)



You can easily make digital recordings from a CD to an MD faster than normal CD-MD Synchro-Recording, marking track numbers in the same sequence as the original CD. Before recording, see “Notes on Recording” on page 19.

 CD text is copied to the MD automatically
When the CD to be recorded using the High-Speed CD-MD Synchro-Recording Function contains track names, this information is recorded onto the MD automatically. Note that CD text on some CDs is copy-protected and thus may not be copied to the MD.



 You can play back tracks just recorded
If “TRACK” lights up in the display when recording has finished, press  immediately to play back from the first track of the material just recorded.

- 1** Press I/O.
The STANDBY indicator turns off.
- 2** Insert a recordable MD.
- 3** Press  OPEN/CLOSE to insert a CD. Press the button again to close the CD tray.
- 4** Press PLAY MODE to select the playing mode of the CD (normal play or Program Play).
- 5** Press CD SYNCHRO HIGH.
“CD SYNCHRO” appears and “-High-” flashes in the display. The MD deck section stands by for recording and the CD player section stands by for playing.
- 6** After “CD SYNCHRO” and “-High-” turn off, press  or  on the right of the front panel.
High-speed recording starts. The MD deck section and the CD player section will automatically stop after recording.

To stop recording
Press  on the right of the front panel.

Notes

- You cannot record over existing material. The system automatically starts recording from the end of the existing material.
- Make sure that the remaining recordable time on the MD is longer than the playing time of the CD, especially if you want to record all the tracks on the CD.
- You cannot pause recording.
- If the play mode is set to Repeat Play or Shuffle Play, it automatically switches to normal play at step 5.
- The recording level specified in the Setup Menu (page 23) is not applied. The initial reference level (0.0 dB) is used instead.
- When recording in LP2 or LP4 Stereo mode, recording takes approximately twice as long as normal high-speed recording.
- The Auto Cut Function does not work.
- With the following kinds of CDs, you may experience a reading failure or noise when recorded to an MD:
 - CDs with adhesive labels attached to them
 - Irregularly shaped CDs (for example, heart- or star-shaped)
 - CDs with printed text concentrated on one side only
 - Old CDs
 - Scratched CDs
 - Dirty CDs
 - Warped CDs

If “–Retry–” flashes in the display after you press  or  in step 6

A reading failure has occurred, and the deck is trying to read the data again.

- If the retry was successful, the deck continues with High-Speed CD-MD Synchro-Recording.
- If the condition of the inserted CD or the deck is poor, and retry fails, High-Speed CD-MD Synchro-Recording is disabled. In this case, the indicator on the CD SYNCHRO NORMAL button flashes and the deck automatically starts recording in normal CD-MD Synchro-Recording. Note that monitoring of the recorded signal is not possible when this occurs.

Do not disconnect the deck from the power source immediately after recording

If you do, recorded material may not be saved to the MD. To save the material, after recording, press  EJECT to take out the MD or turn off the deck. “TOC Writing” will flash at this time.

After “TOC Writing” goes out, you can pull out the AC power cord.

When “TOC Writing” flashes in the display

The deck is currently updating the Table Of Contents (TOC). Do not move the deck or pull out the AC power cord. Changes to an MD made through recording are saved only when you update the TOC by ejecting the MD or turning off the deck.



You can label a track currently being recorded

You can use either the controls on the deck or the buttons on the remote (see pages 33 to 36).

Notes

- If the following occurs during CD playback or recording, a reading error may occur or noise may be produced in the recorded results:
 - The CD tray or other part of the system is bumped.
 - The system is placed on an uneven or soft surface.
 - The system is located near a speaker, door, or other source of vibration.
- If the above reading errors occur, an extra soundless track may be created. You can erase these extra tracks using the edit function of the MD deck.

Using the Display

You can use the display to check disc and track information such as the total track number, total playing time of the tracks, track number and remaining time of the current track, remaining recordable time of the MD, and disc name.

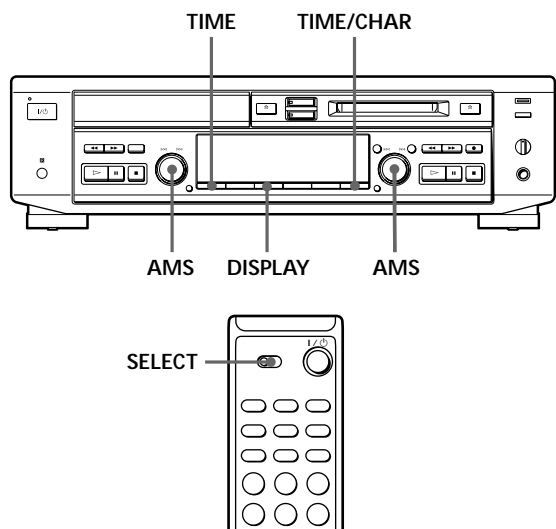

Changing the display

Each time you press DISPLAY while the deck is stopped or playing, you can change the display as follows:

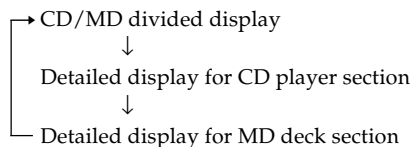

CD/MD divided display

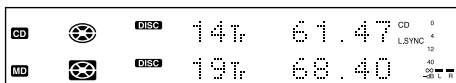

Detailed display for CD player section

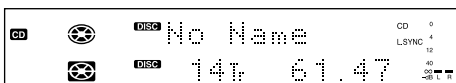

Detailed display for MD deck section



The display changes automatically

Whenever you change the operation status of the deck, the display automatically changes to reflect that status. For example, if you change to CD playback, details about CD playback, such as track number and playing time of the current track, will automatically appear.

The disc name and track names are displayed as follows

When either of the detailed display is selected, the disc name appears whenever the deck is stopped. The name of the current track appears when a track is playing. If the CD has no text information or no title is recorded on the MD, "No Name" appears instead. To label a recordable MD and its tracks, see "Labeling Recordings" on page 33.

You can scroll a title of 12 or more characters

Press SCROLL. Since the display shows up to 11 characters at a time, press SCROLL to see the rest of the title if the title has 12 characters or more. Press SCROLL again to pause scrolling, and again to continue scrolling.

To check the playing time of a track

Turn AMS while the deck is stopped to select the track. When the track number appears, its playing time is also displayed.

Detailed display for CD player section

When using the remote, set SELECT to CD.

Checking the total number of tracks and total playing time of the CD

While the deck is stopped, the information appears as follows:

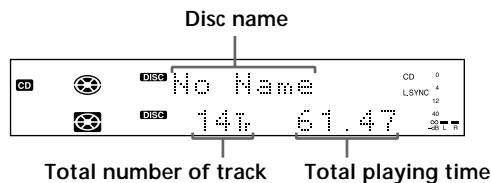

If you insert a CD containing CD TEXT data

"CD TEXT" lights up in the display.

Checking the track number and remaining time of the current track

Press TIME repeatedly while playing a CD. Each time you press the button, the display changes as follows:

Track number and playing time of the current track (normal display)



Track number and remaining time of the current track

Press



Total remaining time of the disc (appears only during normal play)

Press



Press

Detailed display for MD deck section

When using the remote, set SELECT to MD.

Checking the total track number, total disc playing time and remaining recordable time of the MD

Each time you press TIME/CHAR while the deck is stopped, you can change the display as follows:

Total track number and total playing time of all recorded tracks (normal display)

Press



Press

Total track number and remaining recordable time of the disc (recordable MDs only)

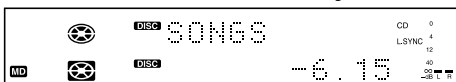

The remaining recordable time of the disc is not shown for premastered MDs.

Press

When you insert an MD, the disc name, total number of tracks and total disc playing time appear in the display as follows:

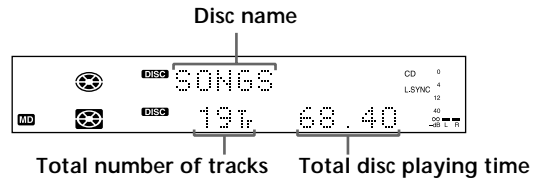

Checking the playing time, remaining time, and track number

Each time you press TIME/CHAR while playing an MD, you can change the display as follows:

Track name, track number, and playing time of the current track (normal display)



Press

Track name, track number, and remaining time of the current track

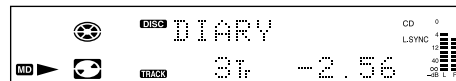

Press

Total remaining playing time of the disc (appears only during normal play)



Press

Locating a Specific Track

You can quickly locate any track while playing a disc by using the AMS (Automatic Music Sensor) control on the deck, **⏮** and **⏭** buttons on the remote, or number buttons on the remote.

When using the remote, set SELECT to CD or MD.

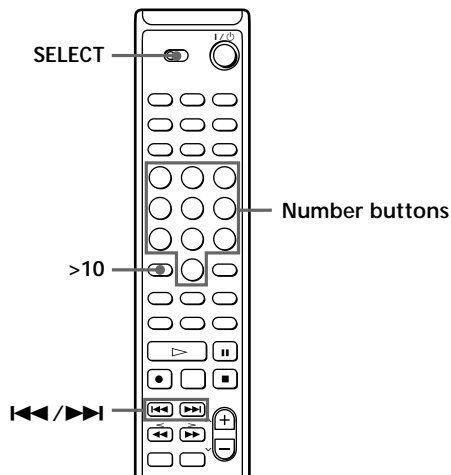
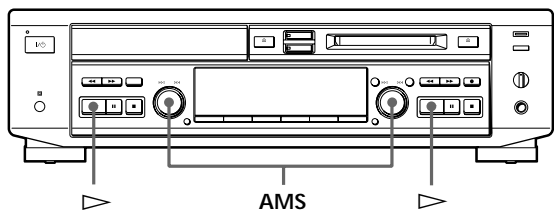

💡 To pause playing at the beginning of a track
Turn AMS (or press **⏮** or **⏭**) after pausing playback.

💡 To go quickly to the beginning of the last track
Turn AMS counterclockwise (or press **⏮**) while the display shows the total track number, total disc playing time or remaining recordable time of the disc (recordable MD only), or disc name (see page 12).

To locate	Do the following:
The next or succeeding tracks	During playback, turn AMS clockwise (or press ⏭ repeatedly) until you find the track.
The beginning of the current or preceding tracks	During playback, turn AMS counterclockwise (or press ⏮ repeatedly) until you find the track.
A specific track directly	Press number button(s) to enter the track number.
A specific track by using AMS	<ol style="list-style-type: none"> 1 While the deck is stopped, turn AMS until the track number you want to locate appears. 2 Press AMS or ▷.

💡 When you directly locate a track with a number over 10

Press **>10** before entering the corresponding digits.
Press **>10** once if it is a 2-digit track number, and twice if it is a 3-digit track number (for MD only).

To enter "0", press 10/0.

- Examples:
- To play track number 30
Press **>10** once, then 3 and 10/0.
 - To play track number 100
Press **>10** twice, then 1, 10/0 and 10/0.

Locating a Particular Point in a Track

You can also use the ◀◀ and ▶▶ buttons to locate a particular point in a track during playback or playback pause.

When using the remote, set SELECT to CD or MD.

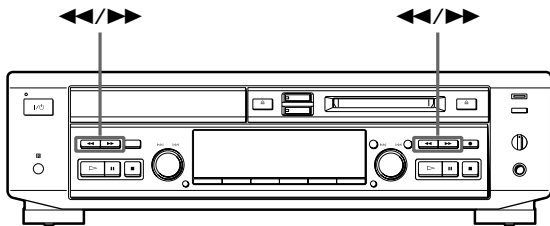

To locate a point	Keep pressing
While monitoring the sound	▶▶ (forward) or ◀◀ (backward) until you find the point.
Quickly by observing the display during playback pause	▶▶ or ◀◀ until you find the point. There is no sound output during this operation.

💡 If “- Over -” appears while you are pressing ▶▶ The disc has reached to its end. Turn AMS counterclockwise (or press ◀◀) or press ◀◀ to go back.

Notes

- If the disc reaches the end while you are pressing ▶▶ during sound monitoring, the deck stops.
- Tracks that are only a few seconds long may be too short to scan using the search function. For such tracks, it is better to play the disc at normal speed.

Playing Tracks Repeatedly (Repeat Play)

You can play tracks repeatedly in any play mode.

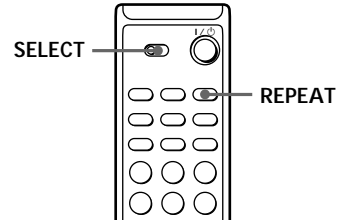

- 1 Set SELECT to CD or MD.
- 2 Press REPEAT repeatedly until “REPEAT” appears in the display.

The deck repeats the tracks as follows:

When the disc is played in	The deck repeats
Normal play (pages 6 and 7)	All the tracks
Shuffle Play (page 16)	All the tracks in random order
Program Play (page 16)	The same program

To stop Repeat Play

Press ■.

To cancel Repeat Play

Press REPEAT repeatedly until “REPEAT” disappears.

Repeating the current track only

While the track you want to repeat is playing in normal, Shuffle or Program Play, press REPEAT repeatedly until “REPEAT 1” appears in the display. If you select “REPEAT 1” while the deck is stopped, the deck repeats the track that you locate to play.

Playing in Random Order (Shuffle Play)

You can have the deck “shuffle” tracks and play them in random order.

When using the remote, set SELECT to CD or MD.

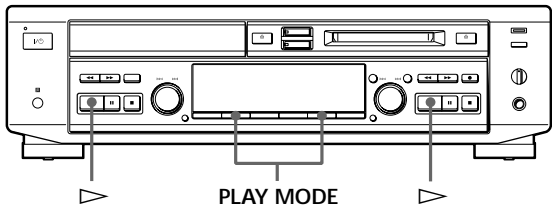

- 1 While the deck is stopped, press PLAY MODE repeatedly until “SHUFFLE” appears in the display.
- 2 Press ▷ to start Shuffle Play. “- Shuffle -” or “E3” appears in the display while the deck is “Shuffling” the tracks.

To stop Shuffle Play

Press ■.

To cancel Shuffle Play

While the deck is stopped, press PLAY MODE repeatedly until “SHUFFLE” disappears.

💡 You can specify tracks during Shuffle Play

- To play the next track, turn AMS clockwise (or press ▶▶).
- To play from the beginning of the current track again, turn AMS counterclockwise (or press ◀◀). You cannot use AMS (or ◀◀) to go back to tracks that have already been played.

Creating Your Own Program (Program Play)

You can specify the playback order of the tracks on a disc and create your own programs containing up to 25 tracks.

When using the remote, set SELECT to CD or MD.

Note

You cannot create a program containing tracks from both CD and MD.

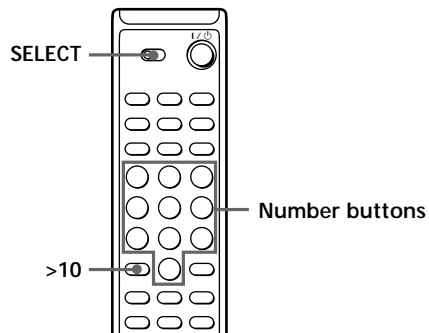
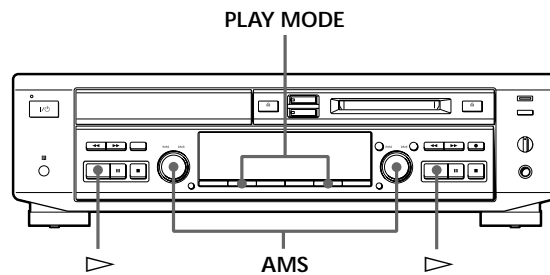

- 1 While the deck is stopped, press PLAY MODE repeatedly until “PROGRAM” appears in the display.

- 2 Turn AMS until the desired track appears.
- 3 Press AMS.
The track is programmed. The number of the last programmed track appears, followed by the total playing time of the program.
- 4 To program additional tracks, repeat steps 2 and 3.
- 5 Press ▷ to start Program Play.

To stop Program Play

Press ■.

To cancel Program Play

While the deck is stopped, press PLAY MODE repeatedly until "PROGRAM" disappears.

To select the desired track using the number buttons

Press number buttons instead of performing steps 2 and 3.

To enter track numbers 10 or over, press >10 and the track number. To enter 0, use the 10/0 button.

To erase the last programmed track

Press CLEAR. Each time you press the button, the last programmed track is erased.

 **The program remains even after Program Play ends**
When you press ▷, you can play the same program again.

Notes

- The display shows "--. --" instead of the total playing time when the total playing time of the program exceeds 99 minutes (999 minutes for MD).
- "Step Full!" appears when you program over 25 tracks.
Erase the unnecessary tracks to enter other tracks.
- The program is erased when you disconnect the AC power cord.
- You cannot use D.SKIP on the remote.

Falling Asleep to Music (Sleep Timer)

You can let the deck turn off after the specified time, so you can sleep to the music.

You can specify the time until the deck turns off by 30 minutes.

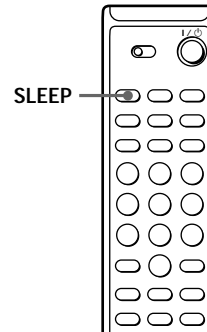

Press SLEEP.

Each time you press the button, the minute display (the turn-off time) changes as follows, and then returns to the original display after a short time. When the Sleep Timer is activated, "SLEEP" appears in the display and the deck turns off after the displayed time has passed.

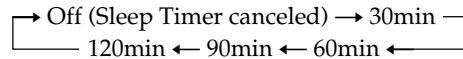

To check the remaining time

Press SLEEP once.

To change the time to turn off

Press SLEEP repeatedly to select the desired time.

To cancel the Sleep Timer operation

Press SLEEP repeatedly until "Off" appears.

Changing the Pitch of the MD (Pitch Control Function)

You can change the pitch of the MD by lowering the playback speed. The tone falls at lower pitches.

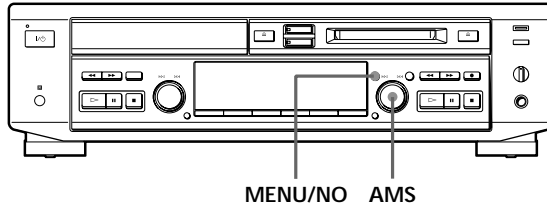

Setting the pitch automatically in steps (Auto Step Control Function)

You can lower the pitch by up to 36 steps*.

* One octave equals 12 steps.

- 1 Press MENU/NO twice to display "Setup Menu."
- 2 Turn AMS to select "Pitch," then press AMS.
- 3 Turn AMS to select the desired step value, then press AMS.
- 4 Press MENU/NO.

To recall the factory setting

Press CLEAR while setting the value.

Notes

- When you change the step value, the playing sound drops out momentarily.
- The step value returns to "0" (factory setting) when you turn off the deck or eject the MD.
- When a dot (.) appears to the right of the step value in the pitch display, this indicates that you have performed fine adjustment (see this page) and the pitch value is between steps. (The step and fine control values are linked.)

Finely controlling the pitch (Fine Control Function)

You can fine control the playing speed in 0.1% increments from -87.5% to 0.0%.

- 1 Press MENU/NO twice to display "Setup Menu."
- 2 Turn AMS to select "Pfine," then press AMS.
- 3 Turn AMS to select the desired value, then press AMS.
- 4 Press MENU/NO.

To recall the factory setting

Press CLEAR while setting the value.

Notes

- The playing sound drops out momentarily when you change the fine control value.
- The fine control value reverts to "0.0%" (factory setting) when you turn off the deck or eject the MD.
- The step and fine control values are linked; changing one value also changes the other.

Notes on Recording

If "Protected" and "C11" alternate in the display

The MD is record-protected. Close the slot to record on the disc (see "To protect an MD against accidental erasure" on page 9).

If "Din Unlock" and "C71" alternate in the display

- The digital program source is not connected as you selected with the INPUT button in step 3 on page 21. To continue, connect the program source properly.
- The program source is not on. Turn on the program source.

Depending on the Setup Menu settings and source being recorded, track numbers are marked in following ways:

- When recording from a CD on the deck or from a CD player or MD deck connected through the DIGITAL OPTICAL IN connector:
The deck automatically marks track numbers in the same sequence as the original.
However, the deck may not automatically mark track numbers in the following cases:
 - When you consecutively record the same track two or more times using single-track repeat play.
 - When you consecutively record two or more tracks with the same track number but from different CDs or MDs.
 - When you record tracks less than 4 seconds long during stereo, monaural, or LP2 Stereo recording (less than 8 seconds long during LP4 Stereo recording).
- When recording from some CD players and multi disc players connected through the DIGITAL OPTICAL IN connector with "OPT" selected by the INPUT button:
The deck may not automatically mark track numbers. In these cases, mark the track numbers after recording, using the deck's Divide Function (see "Dividing Recorded Tracks" on page 30).
- When recording from a source connected through the ANALOG IN jacks with "ANALOG" selected by the INPUT button or when recording from a DAT or satellite broadcast connected through the DIGITAL OPTICAL IN connector with "OPT" selected by the INPUT button and "T.Mark Off" is selected in Setup Menu:
The source will be recorded as a single track.

- Even while recording an analog source or a DAT or satellite broadcast, you can mark track numbers if "T.Mark LSyn" is selected in Setup Menu (see "Marking Track Numbers While Recording" on page 24).
- When recording from DAT or satellite broadcasts with "OPT" selected by the INPUT button, the deck automatically marks a track number whenever the sampling frequency of the input signal changes regardless of track marking setting ("T.Mark LSyn" or "T.Mark Off").



You can mark track numbers during or after recording

For details, see "Marking Track Numbers While Recording" (page 24) and "Dividing Recorded Tracks" (page 30).

When "TOC Writing" flashes in the display

The deck is currently updating the Table Of Contents (TOC). Do not move the deck or pull out the AC power cord. Changes to an MD made through recording are saved only when you update the TOC by ejecting the MD or changing the deck to standby by pressing the I/⏻ switch.

The deck uses the SCMS (Serial Copy Management System on page 45)

The contents of MDs recorded through digital input connector cannot be recorded by this deck through the DIGITAL OPTICAL IN connector.

Useful Tips for Recording

When using the remote, set SELECT to MD.

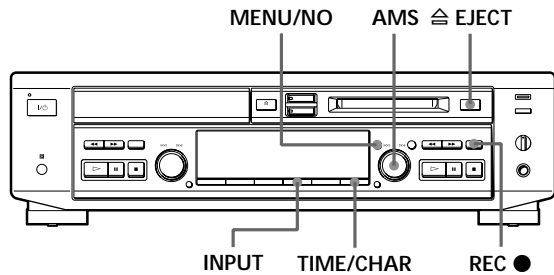

Checking the remaining recordable time on the MD

Press TIME/CHAR.

- When you press the button repeatedly while the deck is stopped, the display alternates between total disc playing time and remaining recordable time on the MD (see page 13).
- When you press the button repeatedly while recording, the display alternates between the recording time of the current track and the remaining recordable time on the MD.

Monitoring the input signal (Input Monitor)

Before starting recording, you can monitor the selected input signal through the deck's output jacks.

- 1 Press ≡ EJECT to remove the MD.
- 2 Press INPUT to select the input signal you want to monitor.
- 3 Press REC ●.

When "ANALOG" is selected

The input analog signal is output to the ANALOG OUT jacks and the PHONES jack after A/D and D/A conversion.

"AD - DA" appears in the display at this time.

When "OPT" is selected

After passing through the Sampling Rate Converter (SRC), the digital signal input from the DIGITAL OPTICAL IN connector is output to the ANALOG OUT jacks and PHONES jack after D/A conversion.

"- DA" appears in the display at this time.

When "CD" is selected

After passing through the Sampling Rate Converter (SRC), the digital signal input from the CD is output to the ANALOG OUT jacks and PHONES jack after D/A conversion.

"- DA" appears in the display at this time.

To stop monitoring the signal

Press ■.

If "Auto Cut" appears in the display (Auto Cut)

There has been no sound input for about 30 seconds during recording. The 30 seconds of silence are replaced by a blank of about 3 seconds and the deck changes to recording pause.

If the deck continues pausing for about 10 minutes after the Auto Cut Function activated, recording stops automatically.

Note that this function does not activate even if there has been no sound input for about 30 seconds when the deck started recording from the blank portion.

Also, this function does not work when recording from the CD player section of this deck.

💡 You can turn off the Auto Cut Function

For details, see "To turn off the Smart Space Function and Auto Cut Function" below. Note that when you turn off the Auto Cut Function, the Smart Space Function is turned off automatically.

If "Smart Space" appears in the display (Smart Space)

There has been an extended silence of 4 to 30 seconds in length during recording. The silence is replaced with a blank of about 3 seconds and the deck continues recording. Note that new track numbers may not be marked for portions recorded while this function is activated. Also, the Smart Space Function does not activate even if there has been an extended silence of 4 to 30 seconds in length when the deck started recording from the blank portion.

To turn off the Smart Space Function and Auto Cut Function

- 1 While the deck is stopped, press MENU/NO twice to display "Setup Menu."
- 2 Turn AMS to select "S.Space On," then press AMS.
- 3 Turn AMS to select "S.Space Off," then press AMS.
- 4 Press MENU/NO.

To turn on the Smart Space Function and Auto Cut Function again

- 1 While the deck is stopped, press MENU/NO twice to display "Setup Menu."
- 2 Turn AMS to select "S.Space Off," then press AMS.
- 3 Turn AMS to select "S.Space On," then press AMS.
- 4 Press MENU/NO.

Notes

- When you turn off the Smart Space Function, the Auto Cut Function is also turned off automatically.
- The Smart Space Function and Auto Cut Function are factory set to on.
- If you turn off the deck or disconnect the AC power cord, the deck will recall the last setting (On or Off) of the Smart Space and Auto Cut Functions the next time you turn on the deck.

Recording on an MD Manually

You can start recording from the end of the existing material or record over the existing tracks just as you would on an analog cassette tape.

When using the remote, set SELECT to CD or MD.

To perform CD-MD Synchro-Recording, see "Recording a CD to an MD" on page 8 or "Recording a CD to an MD at High Speed" on page 10.

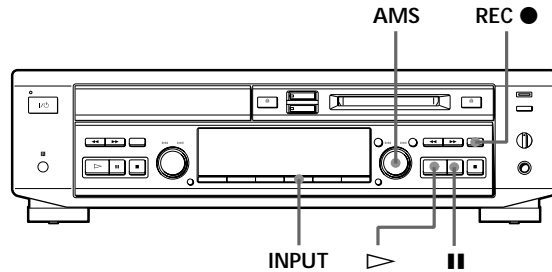

- 1 Turn on the amplifier and set the source selector to the position for the sound source you want to record.
- 2 Insert a recordable MD.
- 3 Press INPUT repeatedly to select the input connector.

To record through	Select
DIGITAL OPTICAL IN	OPT
ANALOG IN	ANALOG

To record from the CD player section manually
Press INPUT repeatedly to select CD.

- 4 Decide a point on the MD where you want to start recording.

To record on a brand new MD or start recording from the end of the existing material
Skip this step.

To record from a specific point of a recorded track
Press ▷ to start playback, and press || at the point where you want to start recording.

To record erasing the previously recorded tracks
Turn AMS (or press ◀◀ or ▶▶ repeatedly) until the number of the track to be recorded over appears in the display.

(Continued)

- 5 Press REC ●.
The deck stands by for recording.
- 6 Adjust the recording level, if necessary.
For details, see “Adjusting the Recording Level” on page 23.
- 7 Press ▷ or ■.
Recording starts.
- 8 Start playing the sound source you want to record.

To pause recording

Press ■. To resume recording, press the button again or press ▷.

Note

Whenever you pause recording, the track number increases by one. For example, if you paused recording while recording on track 4, the track number increases by one and recording continues on the new track when restarted.

To stop recording

Press ■.

 When “Overwrite” flashes in the display in step 5 above
This indicates that the deck will start recording erasing the existing material.

 You can play back tracks just recorded
If “TRACK” lights up in the display when recording has finished, press ▷ immediately to play back from the first track of the material just recorded.

Notes

- You cannot record over the existing material when “PROGRAM” or “SHUFFLE” appears in the display.
- You cannot operate the CD player section while the deck is recording or standing by for recording with “OPT” or “ANALOG” selected with the INPUT button.

Recording for Long Times

This deck has two long time recording modes: LP2 and LP4 (MDLP recording). When recording in LP2 Stereo mode, you can record 2 times the normal recordable time, and in LP4 Stereo mode, you can record 4 times the normal recordable time. In addition, the recordable time for monaural recording is approximately double the stereo recording time.

LP4 Stereo mode (4× long time recording mode) achieves a long stereo recording time by use of a special compression system. When placing emphasis on sound quality, Stereo recording or LP2 Stereo recording (2× long time recording mode) is recommended.

Note

Tracks recorded in MDLP (LP2 or LP4 Stereo) mode cannot be played back on a deck that does not support MDLP mode. In addition, you cannot use S.F Edit and some other MD edit functions for tracks recorded in MDLP mode.

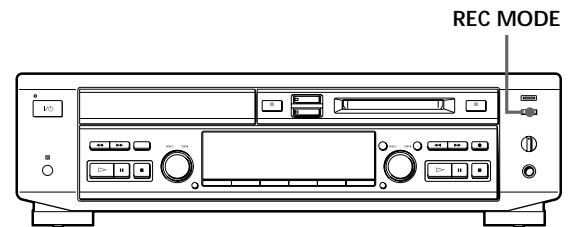

- 1 Do steps 1 to 3 in “Recording on an MD Manually” on page 21.
- 2 Press REC MODE repeatedly to select the recording mode you want to record in.

To record in	Select	Recording time*
Stereo	Blank (No indicator)	60 minutes
LP2 Stereo	LP2	120 minutes
LP4 Stereo	LP4	240 minutes
Monaural	MONO	120 minutes

* Maximum recording time using a 60-minute MD

- 3 Do steps 4 to 8 in “Recording on an MD Manually” on page 21.

To record in CD-MD Synchro-Recording

Do step 2 above and do the procedure in “Recording a CD to an MD” on page 8 or “Recording a CD to an MD at High Speed” on page 10. The recording speed changes according to the recording mode during High-Speed CD-MD Synchro Recording.

Recording mode	Recording speed
Stereo	Quadruple speed
LP2 Stereo	Double speed
LP4 Stereo	Double speed
Monaural	Quadruple speed

To stop recording

Press ■.

💡 When you record on an MD in LP2 or LP4 Stereo mode

The MDLP indicator lights up when you press REC MODE in Step 2 on page 22.

Notes

- MDs recorded in MDLP (LP2 or LP4 Stereo) mode should be played back on a deck that supports MDLP mode. These MDs cannot be played back on other decks.
- Even if you press REC MODE during recording or recording pause, you cannot change the recording mode.
- Even if you press REC MODE repeatedly to select MONO, the monitor signal during recording does not become monaural.

To add “LP:” at the beginning of a track name during MDLP recording

“LP:” appears when you try to play the MD on a deck that does not support MDLP mode. This convenient function lets you know at a glance that the MD cannot be played back. The factory setting is “On”.

- 1 Press MENU/NO twice to display “Setup Menu”.
- 2 Turn AMS to select “LPstamp On”, then press AMS.

Notes

- The recorded “LP:” is a stamp which appears to indicate that the MD cannot be played back when you try to play the MD on a deck that does not support MDLP mode. It does not appear for decks that support MDLP mode.
- When set to “On”, “LP:” is recorded as the track name, so the number of characters that can be input to an MD is reduced. In addition, when you copy a track name with “LP:” added, “LP:” is automatically added to the copied track name. If you divide an “LP:” track using the Divide function, “LP:” is also added to the latter track.

Adjusting the Recording Level

You can adjust the recording level before starting recording.

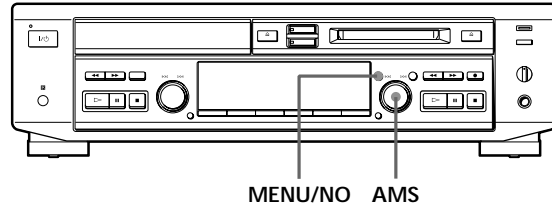

- 1 Do steps 1 to 5 in “Recording on an MD Manually” on page 21.
- 2 Play the portion of the sound source with the strongest signal level.
- 3 Press MENU/NO twice to display “Setup Menu.”
- 4 Turn AMS to select the program source.

To select	Turn AMS to display
CD player section of the deck	CD
a component connected to the DIGITAL OPTICAL IN connector	Opt
a component connected to the ANALOG IN jacks	Anlg

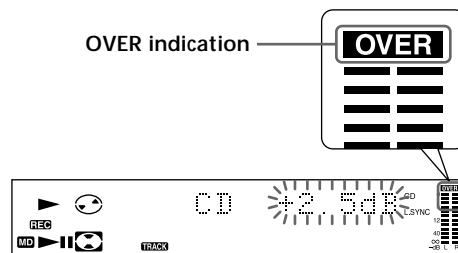

- 5 Press AMS.
- 6 While monitoring the sound, turn AMS to adjust the recording level so that the OVER indication (red) of the peak level meters does not turn on, then press AMS.



Recording level can be adjusted within a range of $-\infty$ to +12 dB.

(Continued)

- 7 Press MENU/NO.
- 8 Stop playing the sound source.
- 9 To start recording, do the procedure starting from step 7 in "Recording on an MD Manually" on page 21.

 You can also change the recording level by using the remote 

During recording pause, press REC LEVEL +/- repeatedly.

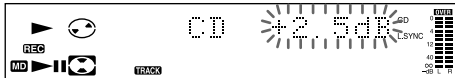

Note that the level cannot go above +12 dB.

Note

You cannot adjust the recording level while playing an MD.

Marking Track Numbers While Recording

You can mark track numbers either manually or automatically. By marking track numbers at specific points, you can quickly locate the points later using the AMS Function or Editing Functions.

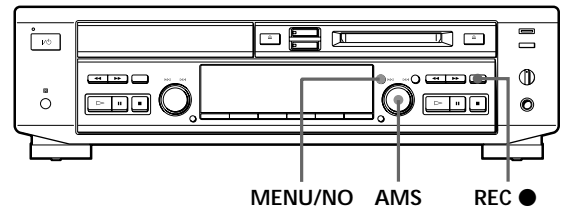

Marking track numbers manually

You can mark track numbers at any time while recording on an MD.

Press REC ● at the place you want to add a track mark while recording.

Marking track numbers automatically (Track Marking Function)

The deck adds track marks differently in the following cases:

- When recording from CDs or MDs with "OPT" selected by the INPUT button (when recording from a CD or MD connected through the DIGITAL OPTICAL IN connector):
The deck marks track numbers automatically according to the information contained in the source being recorded.
However, the deck may not automatically mark track numbers when recording from some CD players and multi disc players.
- In all other cases:
If "T.Mark LSyn" is selected in Setup Menu, the deck marks a new track number whenever the signal drops to the specified level or below for about 1.5 seconds or longer, then rises to a specified level.

Set "T.Mark" in Setup Menu to "LSyn" or "Off" as follows:

- 1 Press MENU/NO twice to display "Setup Menu" while the deck is stopped.
- 2 Turn AMS to select "T.Mark LSyn," then press AMS.
- 3 Turn AMS to select "T.Mark LSyn" or "T.Mark Off," then press AMS.
If you select "T.Mark LSyn," "L.SYNC" lights up in the display.
- 4 Press MENU/NO.

To change the trigger level for Track Marking Function

Do the procedure below to change the signal level that triggers Track Marking Function.

- 1 Press MENU/NO twice to display "Setup Menu" while the deck is stopped.
- 2 Turn AMS to display "LS(T)", then press AMS.
- 3 Turn AMS to select the level, then press AMS.
You can set the level at any value between -72 dB and 0 dB, in 2 dB increments.
- 4 Press MENU/NO.

Note

If you turn off the deck or disconnect the AC power cord, the deck will recall the last setting of the track marking function ("LSyn" or "Off") the next time you turn on the deck.

Recording the Current CD Track (REC-IT Function)

You can record specific tracks on a CD while listening to them. This function allows you to put only the tracks you like onto the MD.

When using the remote, set SELECT to CD.

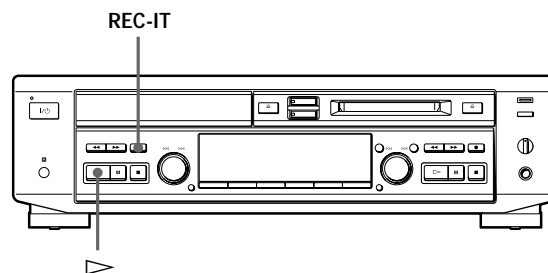

- 1 Press  on the CD player section.
Make sure that the MD deck section is stopped.
- 2 Press REC-IT when you hear a track you want to record.
Play returns to the start of the track and recording starts. The recording stops at the end of the track, but CD playback continues from the next track.

To stop recording

Press  on the CD player section.

Notes

- You cannot record over existing material during REC-IT Recording. The deck automatically starts recording from the end of the existing material.
- Make sure that the remaining recordable time on the MD is longer than the playing time of the CD track.
- The recording level specified in the Setup Menu (page 23) is not applied during REC-IT Recording. The initial reference level (0.0 dB) is used instead.

While "TOC Writing" is flashing

Do not move the deck or pull out the AC power cord to ensure the complete recording. The deck is currently updating the Table Of Contents (TOC) of the MD.

Synchro-Recording With an External Audio Equipment (Music Synchro-Recording)

By using the MUSIC SYNC button on the remote, you can automatically start recording in sync with a CD in the deck or the signal input from the program source connected to the deck.

The method of marking track numbers differs, depending on the program source being recorded and the track marking setting (see “Notes on Recording” on page 19).

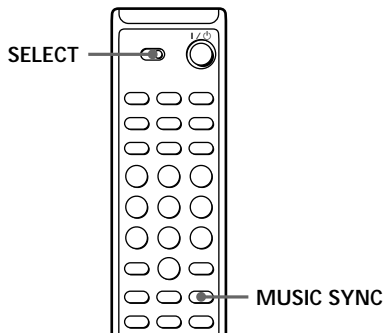

- 1 Do steps 1 to 4 in “Recording on an MD Manually” on page 21.
- 2 Set SELECT to MD.
- 3 Press MUSIC SYNC.
The deck changes to recording pause.
- 4 Start playing the program source you want to record.
The deck starts recording automatically.

To stop Music Synchro-Recording

Press ■.

Note

When Music Synchro-Recording, the Smart Space Function and the Auto Cut Function turn on automatically regardless of their setting (“On” or “Off”).

Starting Recording With Prestored Audio Data (Time Machine Recording)

When recording from an FM or satellite broadcast, the first few seconds of material are often lost due to the time it takes you to ascertain the contents and press the record button. To prevent the loss of this material, the Time Machine Recording Function constantly stores 6 seconds of the most recent audio data in a buffer memory so that when you begin recording the program source using this function, the recording actually begins with the 6 seconds of audio data stored in the buffer memory in advance as shown in the illustration below.

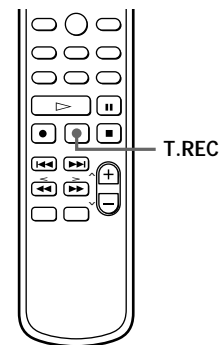
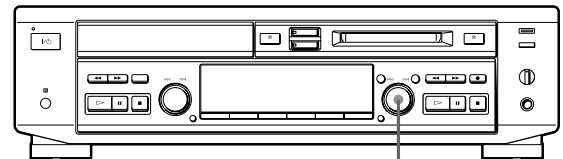
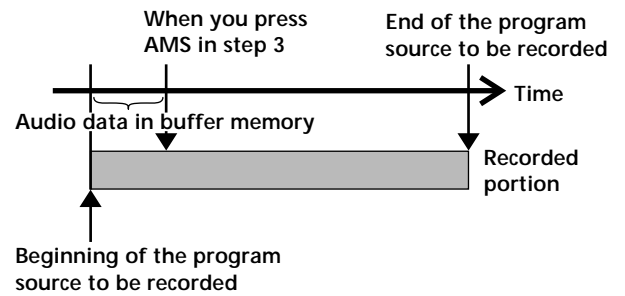

- 1 Do steps 1 to 5 in “Recording on an MD Manually” on page 21.
The deck changes to recording pause.

- 2 Start playing the program source you want to record.
The most recent 6 seconds of audio data is stored in the buffer memory.
- 3 Press AMS (or T.REC) to start Time Machine Recording.
Recording of the program source starts with the audio data stored in the buffer memory.

To stop Time Machine Recording

Press ■.

Note

The deck starts storing audio data when the deck is in recording pause and you start playing the program source. With less than 6 seconds of playing of the program source and audio data stored in the buffer memory, Time Machine Recording starts with less than 6 seconds of audio data.

Fading In and Out (Fader)

You can gradually increase the recording level at the beginning of a recording (fade-in recording) or gradually decrease the recording level at the end of a recording (fade-out recording).

This function is convenient when, for example, you don't want the track cut off abruptly when the disc reaches to its end.

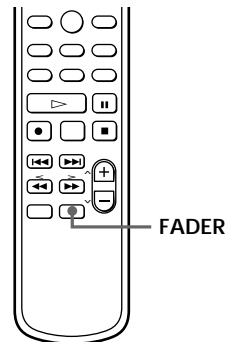

Fade-in recording

During recording pause, press FADER at the position where you want to start fade-in recording.

◀ flashes and the deck performs the fade-in recording until the counter reaches "0.0s."

Fade-out recording

During recording, press FADER at the position where you want to start fade-out recording.

▶ flashes and the deck performs the fade-out recording until the counter reaches "0.0s."

The deck changes to recording pause when fade-out recording finishes.



You can set the duration of fade-in and fade-out recording independently

- 1 While the deck is stopped, press MENU/NO twice to display "Setup Menu."
- 2 To set duration of fade-in recording:
Turn AMS to select "F.in," then press AMS.
To set duration of fade-out recording:
Turn AMS to select "F.out," then press AMS.
- 3 Turn AMS to set the duration.
Both the fade-in and fade-out recording duration can be set within a range of 1.0 second to 15.0 seconds (in 0.1-second steps).
- 4 Press AMS.
- 5 Press MENU/NO.

Notes on Editing

You can edit the recorded tracks after recording, using the following functions:

- Track Erase Function allows you to erase recorded tracks simply by specifying the corresponding track number.
- All Erase Function allows you to erase the contents of an entire MD.
- A-B Erase Function allows you to specify a portion within a track to erase it.
- Divide Function allows you to divide tracks at specified points so that you can quickly locate those points afterwards, using the AMS function.
- Combine Function allows you to combine two tracks into one.
- Move Function allows you to change the order of tracks by moving a specific track to a track position you want.
- Name Function allows you to create and edit titles for your recorded MDs and tracks.
- Undo Function allows you to cancel the last edit.
- S.F Edit Function allows you to change the recorded level after recording.

To enter Edit Menu

- 1 While the deck is stopped, playing, or pausing, press MENU/NO to display "Edit Menu."
- 2 Turn AMS to select the desired editing function, then press AMS.

If "Protected" or "Cannot Edit" appears in the display

The deck could not edit because the record-protect slot on the MD is open. Edit after closing the slot.

When "TOC" and "TOC Writing" flash in the display

Do not move the deck or pull out the AC power cord. After editing, "TOC" lights continuously until you eject the MD or turn off the deck. "TOC" and "TOC Writing" flash while the deck is updating the TOC. When the deck finishes updating the TOC, "TOC" and "TOC writing" turn off.

Erasing Recordings

Do the procedures below to erase following:

- A single track (Track Erase)
- All tracks (All Erase)

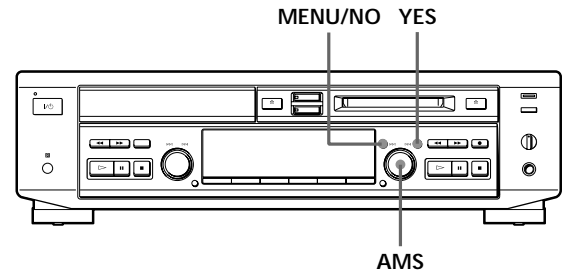

Erasing a single track (Track Erase Function)

You can erase a track simply by specifying the respective track number. When you erase a track, the total number of tracks on the MD decreases by one and all tracks following the erased one are renumbered. Since erasing merely updates the TOC, there is no need to record over material.

- 💡 To avoid confusion when erasing multiple tracks, you should proceed in order of high to low track number to prevent the renumbering of tracks that have not been erased yet.

Example: Erasing B

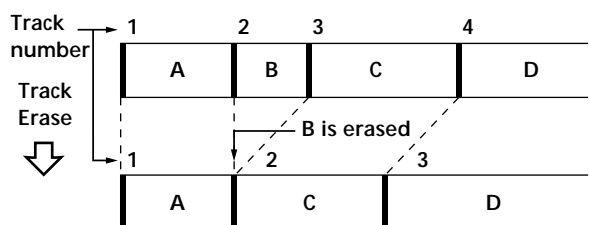

- 1 While the deck is stopped, playing, or pausing, press MENU/NO to display "Edit Menu."
- 2 Turn AMS until "Tr Erase ?" appears in the display.

- 3 Press AMS or YES.
The display for erasing tracks appears and playback of the displayed track starts.
- 4 Turn AMS to select the track to be erased.
- 5 Press AMS or YES.
When the track selected in step 4 has been erased, "Complete!" appears for a few seconds.
The track following the erased track begins playing. (If you erase the last track, the track preceding the erased track starts playing.)
- 6 Repeat steps 1 to 5 to erase more tracks.

To cancel the Track Erase Function
Press MENU/NO or ■.

Erasing all tracks on an MD (All Erase Function)

Erasing a recordable MD deletes the disc name, all recorded tracks, and titles.

- 1 While the deck is stopped, playing, or pausing, press MENU/NO to display "Edit Menu."
- 2 Turn AMS until "All Erase ?" appears in the display.
- 3 Press AMS or YES.
"All Erase??" appears in the display.
- 4 Press AMS or YES.
When the disc name, all recorded tracks, and titles on the MD have been erased, "Complete!" appears for a few seconds.

To cancel the All Erase Function
Press MENU/NO or ■ to turn off the "All Erase??" indication.

 **You can undo the Track Erase or All Erase Function**
Use the Undo Function immediately after you erased the track (see page 37).

Erasing a Part of a Track (A-B Erase Function)

You can specify a portion within a track and erase the portion with ease. It is convenient when erasing unnecessary sections after recording satellite broadcast or FM broadcast.

Example: Erasing a part of track A

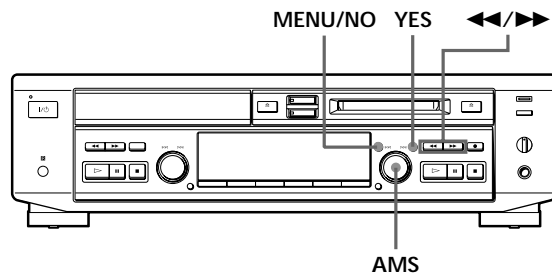
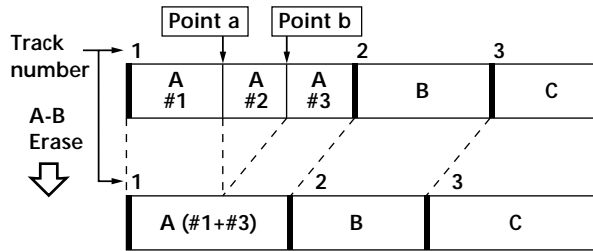

- 1 While the deck is stopped, playing, or pausing, press MENU/NO to display "Edit Menu."
- 2 Turn AMS until "A-B Erase ?" appears in the display, then press AMS or YES.
- 3 Turn AMS to select the number of the track, then press AMS or YES.
"-Rehearsal-" and "Point A ok?" appear alternately while the deck plays the selected track from the beginning to point A.



(Continued)

- 4 While monitoring the sound, turn AMS to find the starting point of the portion to be erased (point A).
You can shift the starting point by 1-frame* (f) intervals (1 frame = 1/86 second).
To shift the point by minute or second intervals, press ◀◀ or ▶▶ so that minute or second flashes.
* When recording in Stereo mode, you can shift the starting point by 2-frame intervals (in LP2 Stereo mode) or by 4-frame intervals (in LP4 Stereo mode).
- 5 If point A is still incorrect, repeat step 4 until it is correct.
- 6 Press AMS or YES if point A is correct.
"Point B set" appears in the display and playback for setting the end point of the portion to be erased (point B) starts.
- 7 Continue playback (or press ◀◀ or ▶▶) until the deck reaches point B, then press AMS or YES.
"A-B Ers" and "Point B ok?" alternate in the display while the deck repeats a portion of a few seconds before point A and after point B successively.
- 8 Repeat step 4 if point B is not correct.
- 9 Press AMS or YES when point B is correct.
"Complete!" appears for a few seconds and the portion between point A and B is erased.

To cancel the A-B Erase Function

Press MENU/NO or ■.

You can undo the A-B Erase Function

Use the Undo Function immediately after you erased the part of the track (see page 37).

Note

If "Impossible" appears in the display, the specified portion cannot be erased.

This sometimes happens when you've edited the same track many times, and is due to a technical limitation of the MD system, not a mechanical error.

Dividing Recorded Tracks (Divide Function)

With the Divide Function you can mark a track number at places that you want to randomly access afterwards. Use this function to add tracks to MDs recorded from an analog source (and therefore contain no track numbers), or to divide an existing track into multiple portions for locating positions in the middle of a track. When you divide a track, the total number of tracks on the MD increases by one and all tracks following the divided track are renumbered.

Example: Dividing track 2 to create a new track for C

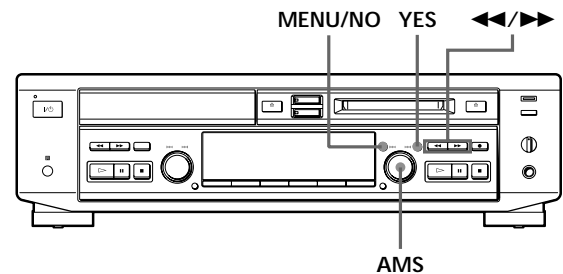
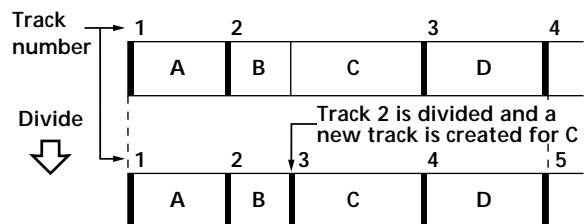

Dividing a track after selecting the track

- 1 While the deck is stopped, playing, or pausing, press MENU/NO to display "Edit Menu."
- 2 Turn AMS until "Divide ?" appears in the display, then press AMS or YES.
- 3 Turn AMS to select the track to be divided and press AMS or YES.
"-Rehearsal-" appears and the portion to be divided is played repeatedly.



- 4 While monitoring the sound, turn AMS to find the point to divide the track.
You can shift the starting point by 1-frame* (f) intervals (1 frame = 1/86 second)
To shift the point by minute or second intervals, press ◀◀ or ▶▶ so that minute or second flashes.
* When recording in Stereo mode, you can shift the starting point by 2-frame intervals (in LP2 Stereo mode) or by 4-frame intervals (in LP4 Stereo mode).
- 5 Press AMS or YES when the position is correct. "Complete!" appears for a few seconds and the newly created track begins playing. The new track will have no track title even if the original track was labeled.

To cancel the Divide Function

Press MENU/NO or ■.

- 💡 You can undo the Divide Function
Use the Undo Function immediately after you divided the track (see page 37).
- 💡 You can divide a track while recording
Mark the track numbers manually or use the Track Marking Function (see page 24).

Dividing a track after selecting the dividing point

- 1 While playing the MD, press AMS at the point where you want to create a new track.
"– Divide –" and "–Rehearsal–" alternate in the display and playback continues from the position you selected.
- 2 To make fine adjustment on the dividing position, do step 4 in "Dividing a track after selecting the track" on page 30.
- 3 Press YES.
"Complete!" appears for a few seconds and the newly created track begins playing.

To cancel the Divide Function

Press AMS, MENU/NO or ■.

Combining Recorded Tracks (Combine Function)

Use the Combine Function to combine tracks on a recorded MD. The two tracks to be combined need not be consecutive and the latter track to be combined can be the track which comes before the former one in the track number order. This function is useful for combining several songs into a single medley, or several independently recorded portions into a single track. When you combine two tracks, the total number of tracks decreases by one and all tracks following the combined tracks are renumbered.

Example: Combining B and D

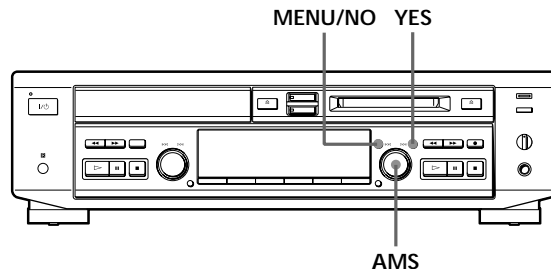
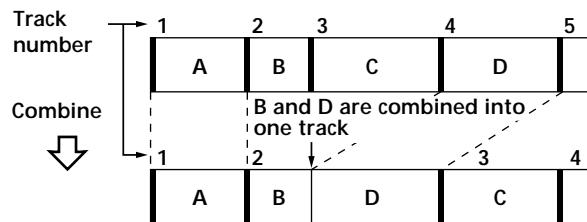

- 1 While the deck is stopped, playing, or pausing, press MENU/NO to display "Edit Menu."
- 2 Turn AMS to select "Combine ?," then press AMS or YES.

(Continued)

- Turn AMS to select the first track of the two to be combined and press AMS or YES. The display for selecting the second track appears and the deck repeats the portion where the two tracks will join (i.e., the end of the first track and the beginning of the succeeding track).

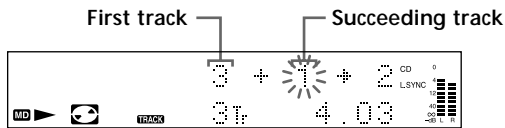

- Turn AMS to select the second track of the two to be combined and press AMS or YES. "Complete!" appears for a few seconds. If both of the combined tracks have track titles, the title of the second track is erased.

To cancel the Combine Function

Press MENU/NO or ■.

💡 You can undo the Combine Function

Use the Undo Function immediately after you combined the tracks (see page 37).

Notes

- Tracks recorded in different modes (stereo, LP2, LP4 or MONO) cannot be combined.
- If "Impossible" appears in the display, the tracks cannot be combined. This sometimes happens when you've edited the same track many times, and is due to a technical limitation of the MD system, not a mechanical error.

Moving Recorded Tracks (Move Function)

Use the Move Function to change the order of any track. After you move a track, the track numbers between the new and old track positions are automatically renumbered.

Example: Moving track C to track position 2

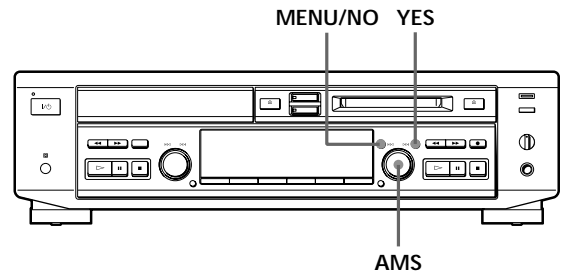
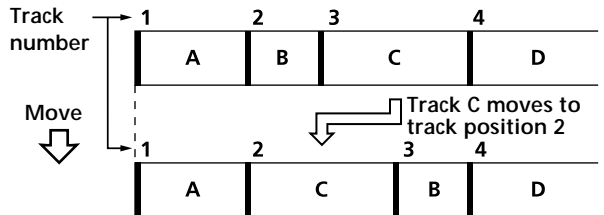

- While the deck is stopped, playing, or pausing, press MENU/NO to display "Edit Menu."
- Turn AMS to select "Move?," then press AMS or YES.
- Turn AMS to select the track to be moved and press AMS or YES.
- Turn AMS until the new track position appears. The deck plays the track to be moved during this time.

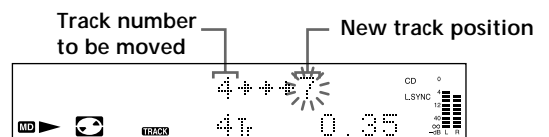

- 5 Press AMS or YES.
"Complete!" appears for a few seconds and the moved track begins playing back.

To cancel the Move Function

Press MENU/NO or ■.

💡 You can undo the Move Function

Use the Undo Function immediately after you moved the track (see page 37).

Labeling Recordings (Name Function)

You can create titles for your recorded MDs and tracks. Titles — which may consist of uppercase and lowercase letters, numbers and symbols for a maximum of about 1,700 characters per disc — appear in the display during MD operation. You can also use the remote to label a track or an MD (see "Labeling tracks and MDs with the remote" on page 35).

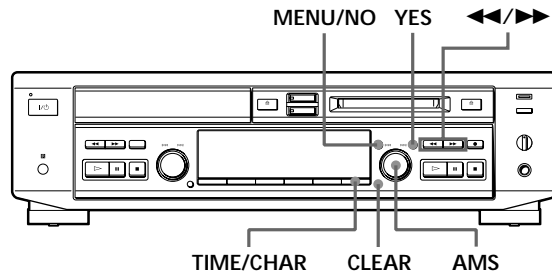

Use the following procedure to label a track or an MD. **You can label a track while it is playing, pausing, recording, or stopped. If the track is recording, be sure to finish labeling before the track ends. If the track ends before you've completed the labeling procedure, the characters already entered are not recorded and the track will remain unlabeled.**

- 1 Press MENU/NO to display "Edit Menu."
- 2 Turn AMS until "Name ?" appears in the display and press AMS or YES.
Skip this step while recording.
- 3 Turn AMS until "Nm In ?" appears in the display, then press AMS or YES.
- 4 Turn AMS to select "Disc" to label an MD, or to specify the track to label.
While recording, go to step 6.

(Continued)

- 5** Press AMS or YES.
A flashing cursor appears in the display.
The deck starts playing and you can name a track while monitoring the sound.



- 6** Press TIME/CHAR to select the character type as follows:

To select	Press TIME/CHAR repeatedly until
Uppercase letters	"A" appears in the display
Lowercase letters	"a" appears in the display
Numbers	"0" appears in the display
Symbols	" " " appears in the display



- 7** Turn AMS to select the character.
The selected character flashes.
Letters, numbers, symbols, and a space appear in sequential order as you turn AMS.
You can use the following symbols in titles:

' - / , . () : ! ? & + < > _ = " ; # \$ % @ * `



You can press TIME/CHAR to change the character type at any time during step 7 (see step 6 above).

- 8** Press AMS to enter the selected character.
The selected character stops flashing and the cursor flashes waiting for the input of the next character.



- 9** Repeat steps 7 and 8 until you have entered the entire title.

If you entered the wrong character

Press ◀ or ▶ until the character to be corrected starts flashing, and repeat steps 7 and 8 to enter the correct character.

To erase a character

Press ◀ or ▶ until the character to be erased starts flashing, then press CLEAR.

To enter a space*

Press AMS while the cursor is flashing. To enter a space after the title, press AMS or ▶▶.

* You cannot select a space for the first character of the title.

- 10** Press YES.

To cancel labeling

Press MENU/NO or ■.

Notes

- You cannot label an MD during recording.
- You cannot label a track or an MD while you are recording over an existing track.

Copying a track or disc title within an MD (Name Copy Function)

You can copy a track or disc title to use it as a title of another track or the disc title within a disc.

- 1 Press MENU/NO to display "Edit Menu."
- 2 Turn AMS to select "Name?," then press AMS or YES.
- 3 Turn AMS to select "Nm Copy?," then press AMS or YES.
- 4 Turn AMS to select "Disc" (when copying the disc title) or the track number (when copying the track title), and press AMS or YES to copy the selected title.

If "No Name" appears in the display

The disc or the track has no name.

- 5 Turn AMS to select "Disc" (when naming the disc) or the track number (when naming a track), and press AMS or YES to enter the copied title. "Complete!" appears for a few seconds to indicate that the copying operation is completed.

If "Overwrite??" appears in the display

The disc or track you selected already has a title. If you continue the title copying, press AMS or YES. If the track has been recorded in MD LP mode with the "LPstamp On" setting (page 23), "Overwrite??" also appears even if a track name is not assigned. In this case if you copy the track name, the "LP:" indication disappears from the track name.

To cancel the Name Copy Function

Press MENU/NO or ■.

Labeling tracks and MDs with the remote

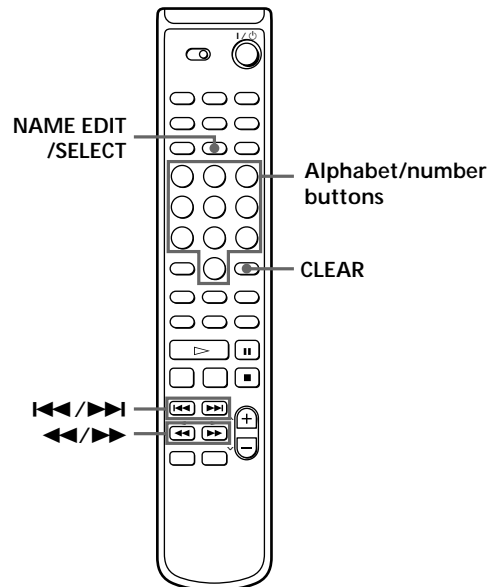

- 1 Press NAME EDIT/SELECT. A flashing cursor appears in the display, then do the following:

To label	Make sure that the deck is
A track	Playing, pausing, recording the track to be labeled, or stopped after locating the track to be labeled
An MD	Stopped with no track number appearing in the display

- 2 Press NAME EDIT/SELECT repeatedly to select the character type as follows:

To select	Press NAME EDIT/SELECT repeatedly until
Uppercase letters and symbols*	"Selected AB" appears in the display
Lowercase letters and symbols*	"Selected ab" appears in the display
Numbers	"Selected 12" appears in the display

* Only ' - / , . () : ! ? can be selected.

You can press 10/0 to enter a space.

(Continued)

- 3 Press an alphabet/number button to enter a character.

If you selected uppercase or lowercase letters

- 1 Press the corresponding letter/number button repeatedly until the character to be entered flashes.

Or, press the button once and press ◀◀/▶▶ repeatedly.

- 2 Press ▶▶.

The flashing character is entered and lights continuously and the cursor shifts to the right.

- 4 Repeat steps 2 and 3 until you have entered the entire title.

If you entered the wrong character

Press ◀◀ or ▶▶ until the character to be corrected starts flashing.

Press CLEAR to erase the incorrect character, then enter the correct one.

- 5 Press YES.

To cancel labeling

Press MENU/NO or ■.

Changing an existing title

- 1 Press NAME EDIT/SELECT, then do the following:

To change	Make sure that the deck is
A track title	Playing, pausing or recording the track whose title is to be changed, or stopped after locating the track whose title is to be changed
A disc name	Stopped with no track number appearing in the display

- 2 Press down CLEAR until the current title is erased.
- 3 Enter the new title.
Do steps 6 to 9 of "Labeling Recordings" on page 33, or steps 2 to 4 of "Labeling tracks and MDs with the remote" on page 35.
- 4 Press YES.

Erasing a title on a disc (Name Erase Function)

Use this function to erase a title on a disc.

- 1 While the deck is stopped, playing, recording, or pausing, press MENU/NO to display "Edit Menu."
- 2 Turn AMS to select "Name ?," then press AMS or YES.
- 3 Turn AMS to select "Nm Erase ?," then press AMS or YES.
- 4 Turn AMS to select "Disc" to erase the disc title, or the track whose title you want to erase and press AMS or YES.
"Complete!" appears for a few seconds and the title is erased.

To cancel the Name Erase Function

Press MENU/NO or ■.

Erasing all titles on an MD (Name All Erase Function)

Use this function to erase all titles on an MD simultaneously.

- 1 While the deck is stopped, playing, or pausing, press MENU/NO to display "Edit Menu."
- 2 Turn AMS to select "Name ?", then press AMS or YES.
- 3 Turn AMS to select "Nm AllErs?", then press AMS or YES.
"Nm AllErs??" appears in the display.
- 4 Press AMS or YES again.
"Complete!" appears for a few seconds and all titles are erased.

To cancel the Name All Erase Function

Press MENU/NO or ■.

 You can undo the Name Erase Function and the Name All Erase Function

See "Undoing the Last Edit" on this page.

 You can erase all recorded tracks and titles
See "Erasing all tracks on an MD" on page 29.

Undoing the Last Edit (Undo Function)

You can use the Undo Function to cancel the last edit and restore the contents of the MD to the condition that existed before editing was done. Note, however, that you cannot undo an edit if you do any of the following after the edit:

- Do another edit.
- Press REC ● on the front panel of the deck or otherwise perform the recording operation.
- Update the TOC by turning off the deck or ejecting the MD.
- Disconnect the AC power cord.

You cannot undo the S.F Edit Function even if you use the Undo Function.

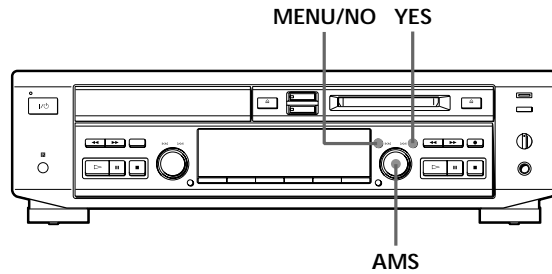

- 1 With the deck stopped and no track number appearing in the display, press MENU/NO to display "Edit Menu."
- 2 Turn AMS until "Undo ?" appears in the display. "Undo ?" does not appear if no editing has been done.

(Continued)

3 Press AMS or YES.

One of the following messages appears in the display, depending on the type of editing to be undone:

Editing done	Message
Erasing a single track	
Erasing all tracks on an MD	"Erase Undo?"
Erasing a part of a track	
Dividing a track	"DivideUndo?"
Combining tracks	"CombinUndo?"
Moving a track	"Move Undo?"
Labeling a track or an MD	
Copying a title	
Changing an existing title	"Name Undo?"
Erasing a title	
Erasing all titles on an MD	

4 Press AMS or YES again.

"Complete!" appears for a few seconds and the contents of the MD are restored to the condition that existed before the edit.

To cancel the Undo Function

Press MENU/NO or ■.

Changing the Recorded Level After Recording (S.F Edit Function)

You can change the volume of recorded tracks using S.F (Scale Factor) Edit. The original track is recorded over at the new recording level. When changing the recording level, you can select Fade-in Recording to gradually increase the signal level at the start of recording, or Fade-out Recording to gradually decrease the signal level at the end of recording.

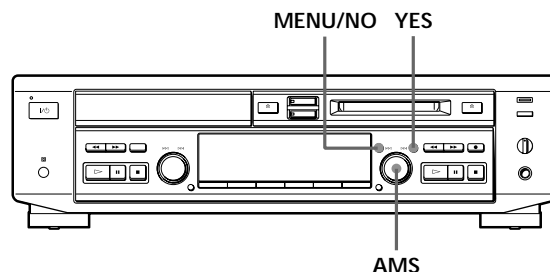

Changing the overall recording level

- 1 While the deck is stopped, press MENU/NO to display "Edit Menu."
- 2 Turn AMS to select "S.F Edit?", then press AMS or YES.
- 3 Turn AMS to select "Tr Level?", then press AMS or YES.
- 4 Turn AMS until the track number you want to change the recording level appears in the display, then press AMS or YES. "Level 0dB" appears in the display.
- 5 While monitoring the sound, turn AMS to change the recorded level so that the OVER indication (red) of the peak level meters does not turn on. You can set the level at any value between -12 dB and +12 dB, in 2 dB increments.

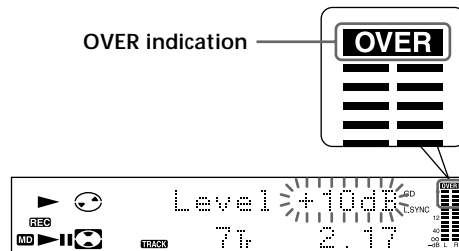

- 6** Press AMS or YES.
"Edit OK?" appears in the display.
- 7** Press AMS or YES.
The deck starts recording over the existing track. "S.F Edit ** %" appears while the track is being recorded. An amount of time that is roughly equal to or longer than the playback time of the track is required when recording over the track. When the recording finishes, "Complete!" appears in the display for a few seconds.

Fade-in and Fade-out Recording

- 1** While the deck is stopped, press MENU/NO to display "Edit Menu."
- 2** Turn AMS to select "S.F Edit?", then press AMS or YES.
- 3** Turn AMS to select "Fade in ?" or "Fade out ?", then press AMS or YES.
- 4** Turn AMS until the track number you want to change the recording level appears in the display, then press AMS or YES.
"Time 5.0s" appears in the display.
- 5** While monitoring the sound, turn AMS to change the Fade-in or Fade-out Recording time.
The deck plays the portion that will be recorded over using Fade-in or Fade-out Recording.
You can set the time at any value between 1 second and 15 seconds, in 0.1 second increments. You cannot set the time longer than the track.
- 6** Press AMS or YES.
"Edit OK?" appears in the display.

- 7** Press AMS or YES.
The deck starts recording over the existing track. "S.F Edit ** %" appears while the track is being recorded. When the recording finishes, "Complete!" appears in the display for a few seconds.

To cancel the operation

Press MENU/NO or ■ in steps 1 to 6. If you press AMS or YES in step 7 and recording starts, you cannot interrupt the operation.

Notes

- You cannot change the recorded level of a track recorded in LP2 or LP4 Stereo mode.
- Do not disconnect the AC power cord or move the deck while recording is in progress. This may damage the recording data preventing recording from being performed properly.
- Do not use an MD that is damaged or dirty. This may prevent recording data from being recorded properly.
- Repeatedly changing the recording level results in poor sound quality.
- The recording level will not return to the exact original level once the recording level has been changed even if it returned to the original level.
- You cannot undo the S.F Edit Function even if you use the Undo Function.

Precautions

On safety

Should any solid object or liquid fall into the cabinet, unplug the deck and have it checked by qualified personnel before operating it any further.

On power sources

- Before operating the deck, check that the operating voltage of the deck is identical with your local power supply. The operating voltage is indicated on the nameplate at the rear of the deck.
- The voltage selector is located at the rear of the apparatus.
- The unit is not disconnected from the AC power source (mains) as long as it is connected to the wall outlet, even if the unit itself has been turned off.
- If you are not going to use the deck for a long time, be sure to disconnect the deck from the wall outlet. To disconnect the AC power cord, grasp the plug itself; never pull the cord.
- AC power cord must be changed only at the qualified service shop.

On condensation in the deck

If the deck is brought directly from a cold to a warm location, or is placed in a very damp room, moisture may condense on the lenses inside the deck. Should this occur, the deck may not operate properly. In this case, remove the CD or MD and leave the deck turned on for about an hour until the moisture evaporates.

On handling CDs

- To keep the CD clean, handle the CD by its edge. Do not touch the surface.
- Do not stick paper or tape onto the CD.
- Do not expose the CD to direct sunlight or heat sources such as hot air ducts, nor leave it in a car parked in direct sunlight as there can be a considerable rise in temperature inside the car.
- Sticky adhesives or inks from the CD label, if present, may become attached to internal parts, causing jamming of the CD or malfunction of the unit. Always check the CD label carefully for sticky substances before inserting the CD. Do not use the following types of CDs:
 - Rental or used CDs with adhesive extending out from the edge of the sticker. Check along the edge of the sticker for stickiness.
 - CDs with labels printed with special inks that are sticky to the touch.

On the MiniDisc cartridge

- Do not open the shutter to expose the MD.
- Do not place the cartridge where it will be subject to extremes of sunlight, temperature, moisture or dust.

On cleaning

Clean the cabinet, panel and controls with a soft cloth slightly moistened with a mild detergent solution. Do not use any type of abrasive pad, scouring powder or solvent such as alcohol or benzine.

If you have any questions or problems concerning your deck, please consult your nearest Sony dealer.

Display Messages

The following table explains the various messages that appear in the display. Also, the deck has a Self-Diagnosis Function (see page 50).

Message	Meaning
Blank Disc	A new (blank) or erased MD has been inserted.
Cannot Copy	An attempt was made to make a second copy from a digitally dubbed MD (see page 45).
Cannot Edit	An attempt was made to edit the MD during Program or Shuffle Play or to change the recording level of an MD recorded in LP2 or LP4 Stereo mode. Or the MD is record-protected.
CD Error!	An operational error has occurred in the CD player section. Wait a few seconds, and then try the operation again.
Disc Full!	The MD is full (see "System Limitations" on page 42).
Edit NOW	You pressed I/⏻ while in S.F Edit (changing the recording level after recording, Fade-in, Fade-out) mode. If you turn off the deck while in S.F Edit mode, any changes that you have made will not be made properly. Finish the changes and leave S.F Edit mode before turning off the deck.
Impossible	The deck cannot do the specified editing operation (see pages 30 and 32).
Incomplete!	The S.F Edit (changing the recording level after recording, Fade-in, Fade-out) operation was not performed properly because the deck was moved while recording was in progress or the MD is damaged or dirty.
Initialize (flashing when you turn on the deck)	This happens when the deck has been disconnected from the AC power source for certain period of time.
Name Full!	The titling capacity of the MD has reached its limit (about 1,700 characters).
No Change	While attempting to change the recording level after recording, you pressed AMS or YES without actually changing the recording level, so no change was made.
No Disc	There is no MD in the deck.
No Name	The disc or track has not been labeled.
Premastered	An attempt was made to record on the premastered MD.

Message	Meaning
-Retry-	The deck is retrying reading data from the CD (see page 11).
Step Full!	The program contains the maximum number of tracks. You cannot set additional tracks.
TextProtect	There is information in the CD text that cannot be recorded to an MD.

System Limitations

The recording system in your deck is radically different from those used in cassette and DAT decks and is characterized by the limitations described below. Note, however, that these limitations are due to the inherent nature of the MD recording system itself and not to mechanical causes.

“Disc Full!” lights up even before the MD has reached the maximum recording time

When 255 tracks have been recorded on the MD, “Disc Full!” lights up regardless of the total recorded time. More than 255 tracks cannot be recorded on the MD. To continue recording, erase unnecessary tracks or use another recordable MD.

“Disc Full!” lights up before the maximum number of tracks is reached

Fluctuations in emphasis within tracks are sometimes interpreted as track intervals, incrementing the track count and causing “Disc Full!” to light up.

The remaining recording time does not increase even after erasing numerous short tracks

Tracks under 12 seconds* in length are not counted and so erasing them may not lead to an increase in the recording time.

* During stereo recording. (approximately 24 seconds during monaural and LP2 stereo recording, or 48 seconds during LP4 stereo recording)

Some tracks cannot be combined with others

Track combination may become impossible when tracks are edited.

The total recorded time and the remaining time on the MD may not total the maximum recording time

Recording is done in minimum units of 2 seconds* each, no matter how short the material. The contents recorded may thus be shorter than the maximum recording capacity. Disc space may also be further reduced by scratches.

* During stereo recording. (approximately 4 seconds during monaural and LP2 stereo recording, or 8 seconds during LP4 stereo recording)

Tracks created through editing may exhibit sound dropout during search operations.

Track numbers are not recorded correctly

Incorrect assignment or recording of track numbers may result when CD tracks are divided into several smaller tracks during digital recording. Also, when the Track Marking Function is activated during recording, track numbers may not be marked as in the original depending on the program source.

Extra tracks are created

When there is a long silence between CD tracks, an extra track may be created.

“TOC Reading” appears for a long time

If the inserted recordable MD is brand new, “TOC Reading” appears in the display longer than for MDs that have been used.

Limitations when recording over an existing track

- The correct remaining recording time may not be displayed.
- You may find it impossible to record over a track if that track has been recorded over several times already. If this happens, erase the track using the Track Erase Function (see page 28).
- The remaining recording time may be shortened out of proportion to the total recorded time.
- Recording over a track to eliminate noise is not recommended since this may shorten the duration of the track.
- You may find it impossible to label a track while recording over it.

The correct recorded/playing time may not be displayed during playback of monaural-format MDs.

Troubleshooting

If you experience any of the following difficulties while using the deck, use this troubleshooting guide to help you remedy the problem.

CD player section

The player does not start playing.

- ➔ Insert a CD.
- ➔ Place the CD properly.
- ➔ Clean the CD.
- ➔ Moisture condensation has formed inside the deck. Take the CD out and leave the deck turned on for about an hour until the moisture evaporates.

MD deck section

The deck does not operate or operates poorly.

- ➔ The MD may be damaged ("Read Error" appears). Take the MD out and insert it again. If "Read Error" remains, replace the MD.

The deck does not play back.

- ➔ Moisture has formed inside the deck. Take the MD out and leave the deck in a warm place for several hours until the moisture evaporates.
- ➔ Press I/⏻ to turn the deck on.
- ➔ Slide the MD into the disc slot with the label side up and the arrow pointing towards the opening.
- ➔ Replace the disc with one that has been recorded.

The deck does not record.

- ➔ The MD is record-protected ("Protected" and "C11" alternate). Close the record-protect slot (see page 9).
- ➔ Make connections properly to the sound source.
- ➔ The sound source is not connected to the selected input connector. Select the correct input connector using INPUT.
- ➔ The recording level is not adjusted properly. Adjust the recording level properly (see page 23).
- ➔ A premastered MD is inserted. Replace it with a recordable MD.
- ➔ There is not enough time left on the MD. Replace it with another recordable MD with fewer recorded tracks, or erase unnecessary tracks.
- ➔ There has been a power failure or the AC power cord has been disconnected during recording. Data recorded to that point may be lost. Repeat the recording procedure.

The deck does not edit.

- ➔ Press PLAY MODE repeatedly until "PROGRAM" and "SHUFFLE" disappear.
- ➔ Close the record-protect slot.

The sound has a lot of static.

- ➔ Strong magnetism from a television or a similar device is interfering with operations. Move the deck away from the source of strong magnetism.

The three- or five-digit display appears.

- ➔ The Self-Diagnosis Function is on. Check the table on page 50.

Others

No sound is output.

- ➔ Make the connections properly.
- ➔ Operate the amplifier properly.
- ➔ When using the headphones, turn PHONE LEVEL to turn up the output level.

The remote does not operate the deck.

- ➔ Make sure that there is no obstacles between the deck and the remote.
- ➔ Point the remote at the remote sensor on the deck.
- ➔ Replace the batteries in the remote.

After you've attempted the prescribed remedies

If the deck still does not operate properly, or if other problems not described above occur, turn off the deck, then reinsert the plug into the power outlet.

If the problem persists, reset the system as follows:

- 1 Turn off the deck and unplug the AC power cord.
- 2 Reinsert the plug into the power outlet while pressing down I/⏻.

Should any problem persist even after resetting the system, consult your nearest Sony dealer.

Specifications

To prevent fire, do not cover the ventilation of the apparatus with news papers, table-cloths, curtains, etc. And don't place lighted candles on the apparatus.

CD player section

System	Compact Disc digital audio system
Laser	Semiconductor laser ($\lambda = 780 \text{ nm}$) Emission duration: continuous
Laser output	Less than $44.6 \mu\text{W}^*$ * This output is the value measured at a distance of 200 mm from the objective lens surface on the Optical Pick-up Block with 7 mm aperture.
Frequency response	5 to 20,000 Hz $\pm 0.5 \text{ dB}$
Signal-to-noise ratio	More than 98 dB
Wow and flutter	Below measurable limit

MD deck section

System	MiniDisc digital audio system
Disc	MiniDisc
Laser	Semiconductor laser ($\lambda = 780 \text{ nm}$) Emission duration: continuous
Laser output	Less than $44.6 \mu\text{W}^*$ * This output is the value measured at a distance of 200 mm from the objective lens surface on the Optical Pick-up Block with 7 mm aperture.
Laser diode properties	Material: GaAlAs
Revolutions (CLV)	800 rpm to 1,800 rpm
Error correction	Advanced Cross Interleave Reed Solomon Code (ACIRC)
Sampling frequency	44.1 kHz
Coding	Adaptive Transform Acoustic Coding (ATRAC)/ATRAC 3
Modulation system	EFM (Eight-to-Fourteen Modulation)
Number of channels	2 stereo channels
Frequency response	5 to 20,000 Hz $\pm 0.5 \text{ dB}$
Signal-to-noise ratio	Over 98 dB during playback
Wow and flutter	Below measurable limit

Inputs

	Jack type	Input impedance	Rated input	Minimum input
ANALOG IN	Phono jacks	47 kilohms	500 mVrms	125 mVrms
DIGITAL OPTICAL IN	Square optical connector jack	Optical wave length: 660 nm	—	—

Outputs

	Jack type	Rated output	Load impedance
PHONES	Stereo phone jack	10 mW	32 ohms
ANALOG OUT	Phono jacks	2 Vrms (at 50 kilohms)	Over 10 kilohms

General

Power requirements

Where purchased	Power requirements
U.S.A. and Canada	120 V AC, 60 Hz
Europe	220 - 230 V AC, 50/60 Hz
Certain countries in Asia	220 - 240 V AC, 50/60 Hz
Other countries	110 - 120 or 220 - 240 V AC selectable, 50/60 Hz

Power consumption 22 W (less than 1 W at standby)

Dimensions (approx.) (w/h/d) incl. projecting parts and controls
430 × 120 × 290 mm

Mass (approx.) 4.7 kg

Supplied accessories

See page 4.

US and foreign patents licensed from Dolby Laboratories.

Design and specifications are subject to change without notice.

Guide to the Serial Copy Management System

This MD deck uses the Serial Copy Management System, which allows only first-generation digital copies to be made of premastered software via the deck's digital input jack. An outline of this system appears below:

- 1 You can record from digital program sources (CDs, DATs or premastered MDs) onto a DAT tape or recordable MD via digital input jack on the DAT or MD deck. You cannot, however, record from this recorded DAT tape or MD onto another DAT tape or recordable MD via the digital input jack on the DAT or MD deck.

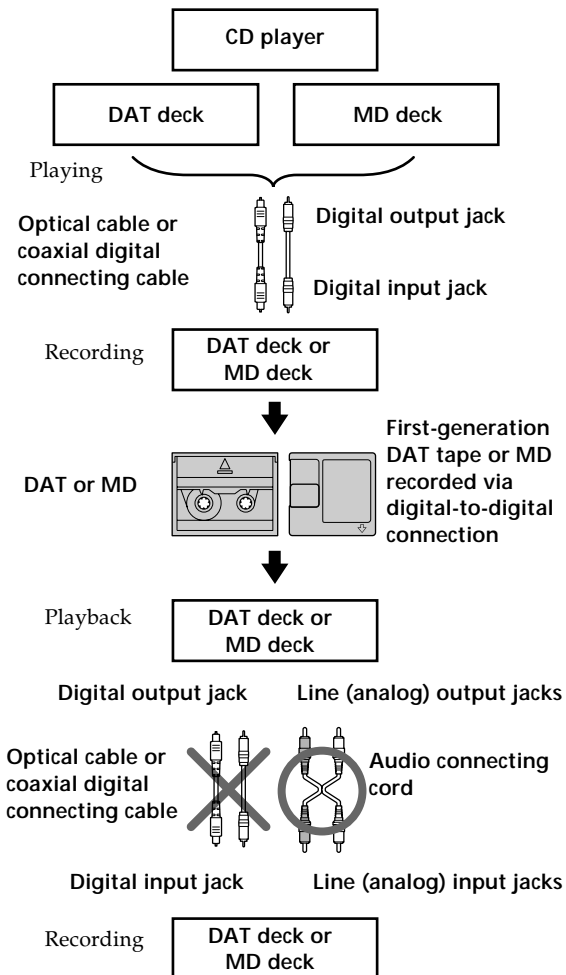

- 2 You can record the digital input signal of a digital satellite broadcast onto a DAT tape or recordable MD via the digital input jack on the DAT or MD deck which is capable of handling a sampling frequency of 32 kHz or 48 kHz. You can then record the contents of this recorded DAT tape or MD (first-generation) onto another DAT tape or recordable MD via digital input jack on the DAT or MD deck to create a second-generation digital copy. Subsequent recording from the second-generation copy onto another recordable DAT tape or MD is possible only through the analog input jack on the DAT or MD deck. Note, however, that on some BS/CS tuners, second-generation digital copying may not be possible.

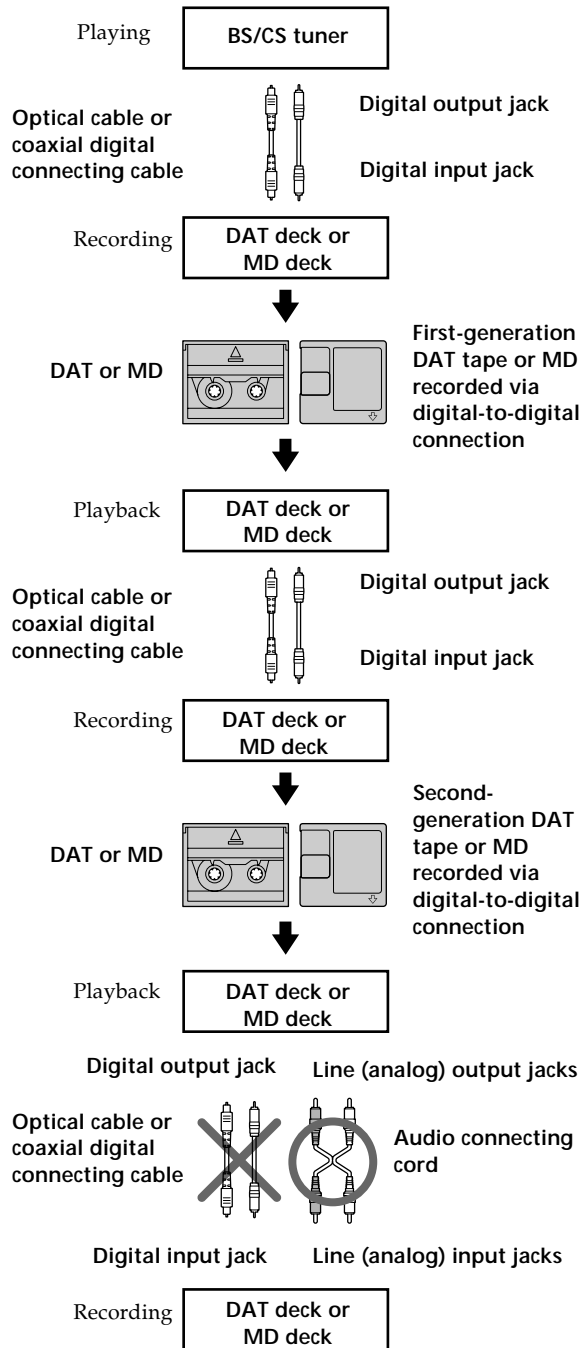

(Continued)

Additional Information

- 3 You can record a DAT tape or MD recorded via the DAT or MD deck's analog input jack onto another DAT tape or MD via the DAT or MD deck's digital output jack. You cannot, however, make a second-generation DAT tape or MD copy via the DAT or MD deck's digital output jack.

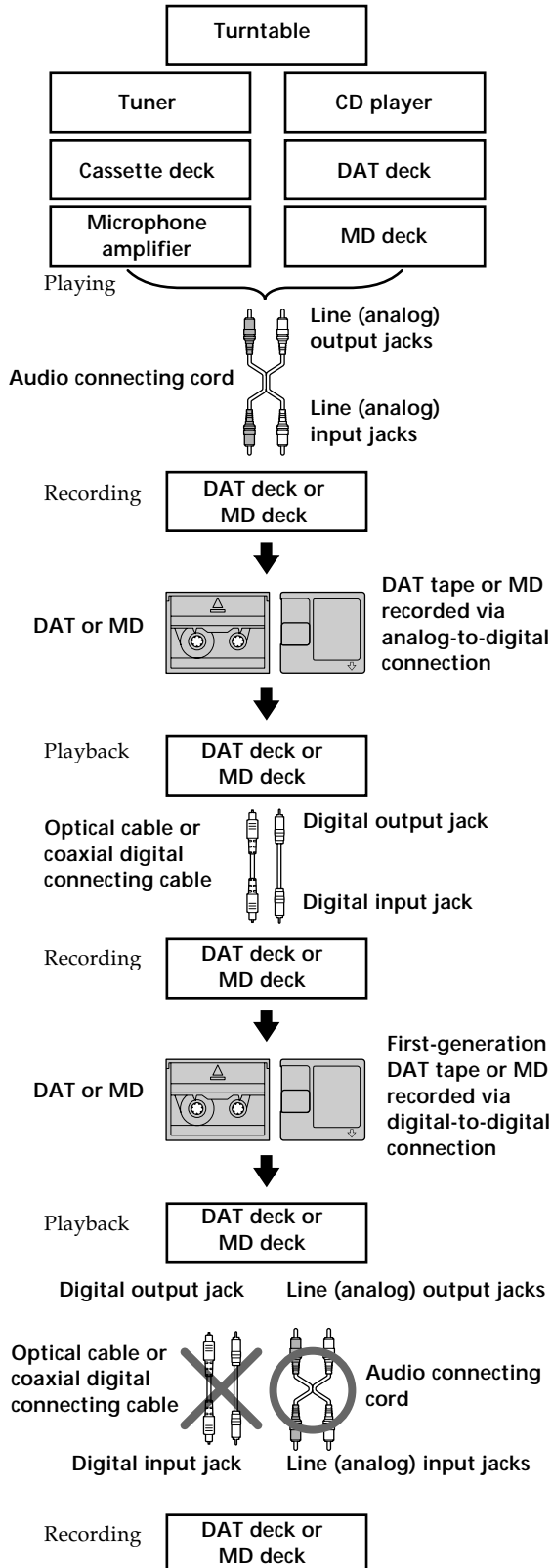

Index

A, B

- AMS (Automatic Music Sensor) 14
- Audio connecting cord 4, 45
- Auto cut 20

C

- CD
 - inserting 6
 - taking out 6
 - text 8, 10
- Changing
 - an existing title 36
 - display 12
- Checking
 - remaining time 13
 - playing time 12, 13
 - total number of tracks 12, 13
 - track name 12, 13
 - track number 12, 13
- Cleaning 40, 51
- Combining 31

D

- Display messages 41
- Dividing
 - after selecting the dividing point 31
 - after selecting the track 30

E

- Erasing
 - all titles 37
 - all tracks 29
 - a part of a track 29
 - a single track 28
 - a title 36

F, G

- Fade-in recording 27
- Fade-out recording 27

H

- Hooking up
 - a digital component 4
 - an analog component 4

I, J, K

- Input monitor 20

L

- Labeling
 - an MD 33
 - a track 33
 - copying a title within an MD 35
 - with the remote 35
- Locating
 - a particular point in a track 15
 - a specific track 14

M, N

- MD
 - inserting 7
 - premastered 13
 - recordable 8, 10
 - taking out 7
- Moving 32

O

- Optical cable 4, 45

P, Q

- PC LINK 5
- Pitch control 18
- Playing
 - CD 6
 - MD 7
 - normal play 6, 7
 - program play 16
 - repeat play 15
 - shuffle play 16

R

- Recording
 - CD-MD synchro-recording 8
 - erasing tracks 28
 - high-speed CD-MD synchro-recording 10
 - level 23
 - manual recording 21
 - music synchro-recording 26
 - REC-IT function 25
 - time machine recording 26
 - long time recording 22
- Recording mode 22
- Record-protect tab 9
- Remote commander (remote) 4

S

- Sampling frequency 5, 45
- Sampling rate converter 5, 20
- SCMS (Serial Copy Management System) 19, 45
- Self-diagnosis 50
- Setup Menu 49
- Sleep Timer 17
- Smart space 20
- Specifications 44
- Supplied accessories 4
- System limitations 42

T

- Track marking
 - automatic track marking 24
 - manual track marking 24
- Troubleshooting 43

U, V, W, X, Y, Z

- Undoing the last edit 37

(Continued)

Names of controls

Buttons

Alphabet/Number 14, 35
CD SYNCHRO HIGH 10
CD SYNCHRO NORMAL 8
CLEAR 17, 33
DISPLAY 12
⊞ EJECT 7, 20
FADER 27
INPUT 20
MENU/NO 18, 23, 28
MUSIC SYNC 26
NAME EDIT/SELECT 35
⊞ OPEN/CLOSE 6
PLAY MODE 8
REC ● (recording) 20
REC-IT 25
REC LEVEL +/- 24
REC MODE 22
REPEAT 15
SCROLL 12
SLEEP 17
TIME(/CHAR) 12, 20, 33
T.REC 26
YES 28
▷ (play) 6, 7, 14, 21
⏸ (pause) 6, 7, 21
■ (stop) 6, 7, 15, 20, 29
◀◀/▶▶ (manual search)
15, 29
◀◀/▶▶ (AMS: Automatic
Music Sensor) 6, 14
>10 14

Connector

DIGITAL OPTICAL IN 21, 44

Controls

AMS 6, 7, 12, 20, 28
PHONE LEVEL 6, 7

Indicators

MD LP 22
STANDBY 6

Jacks

ANALOG IN/OUT 5, 21, 44
PHONES 6, 7, 44

Switches

SELECT 6, 7, 14, 26
I/⏻ (power) 6, 7

Others

Display 12
TOC 28
TOC Writing 9, 19, 28
📄 4

Table of Setup Menus

You can make various settings on this deck by using Setup Menus. Operation related to each menu were explained in the previous sections. The table below outlines each menu, including the various parameters and initial settings.

Note

The menus you can use while the deck is stopped, playing or recording differ.

To enter the Setup Menu

While the deck is stopped, press MENU/NO twice to display "Setup Menu."

Menu	Function	Parameters	Initial setting	See
T.Mark	Sets the Track Marking Function.	LSyn/Off	LSyn	page 24
LS (T)	Changes the trigger level for Track Marking Function.	-72 to 0dB	-50dB	page 25
S.Space	Sets the Smart Space and Auto Cut Functions.	On/Off	On	page 20
F.in	Sets the fade-in time.	1.0s to 15.0s	5.0s	page 27
F.out	Sets the fade-out time.	1.0s to 15.0s	5.0s	page 27
Pitch	Changes the playing speed by auto steps.	-36 to 0	0	page 18
Pfine	Fine controls the playing speed.	-87.5 to 0.0%	0.0%	page 18
CD	Adjusts the input level from the CD player section.	-∞dB to +12.0dB	0.0dB	page 23
Opt	Adjusts the input level from the DIGITAL OPTICAL IN connector.	-∞dB to +12.0dB	0.0dB	page 23
Anlg	Adjusts the input level from the ANALOG IN jacks.	-∞dB to +12.0dB	0.0dB	page 23
LPstamp	Sets whether to automatically add "LP:" at the beginning of a track name during a long time recording.	On/Off	On	page 23

To reset to the initial setting

Press CLEAR while the respective Setup Menu is displayed.

Self-Diagnosis Function

The deck has a self-diagnosis display. This function shows a three- or five-digit display (a combination of a letter and figures) and the corresponding message, so you can check the deck's condition.

If such a display appears, check the following table in order to resolve the problem.

Should any problem persist, consult your nearest Sony dealer.

Three- or five-digit display/Message	Cause/Remedy
C11/Protected	The inserted MD is record-protected. ➔ Take out the MD, and close the record-protect tab (page 9).
C12/Cannot Copy	An attempt was made to play a disc that is not compatible with this deck (CD-ROM, MD data disc, etc.). ➔ Replace the disc.
C13/Rec Error	The recording was not made properly. ➔ Set the deck in a stable place, and repeat the recording procedure. The inserted MD is dirty (with smudges, fingerprints, etc.), scratched, or not up to standards. ➔ Replace the disc, and repeat the recording procedure.
C13/Read Error	The deck could not read the TOC of the MD properly. ➔ Eject the disc, then insert it again.
C14/Toc Error	The deck could not read the TOC of the MD properly. ➔ Insert another disc. ➔ If possible, erase all tracks on the MD using the All Erase Function on page 29.
C41/Cannot Copy	The digitally dubbed material cannot be recorded digitally (page 45).
C71/Din Unlock	A moment's lighting is due to the signals of the digital program being recorded. This does not affect the recorded material. While recording from a digital component connected through the DIGITAL OPTICAL IN connector, the digital connecting cable was unplugged or the digital component turned off. ➔ Connect the cable or turn the digital component back on.
E0001/MEMORY NG	There is an error in the internal data that the deck needs in order to operate. ➔ Consult your nearest Sony dealer.
E0101/LASER NG	There is a problem with the optical pickup. ➔ The optical pickup may have failed. Consult your nearest Sony dealer.

Notes on CDs

On handling CDs

- To keep the disc clean, hold it along its edges only. Do not leave fingerprints on the surface.
- Do not stick adhesive papers or tapes onto the disc.



- Only regular circular discs can be used in this deck. Irregularly shaped discs, such as star- or heart-shaped discs, may damage the deck.
- If there is glue or a similar substance on the disc, remove it completely before using the disc.

On storage

- Do not expose the disc to direct sunlight, heat sources, or high humidity.
- Store discs in their cases. Do not store discs either stacked horizontally or standing vertically without their cases.

On cleaning

- Fingerprints or dust on the CD may cause poor sound reproduction or sound dropout.
- Before playing a disc, clean it with a cleaning cloth. Wipe the disc from the center out.
- If the disc is still dirty after being wiped with a cleaning cloth, wipe it again with a slightly moistened cloth. Then wipe off the residual moisture with a dry cloth.
- Do not use solvents such as benzene, thinner, commercially available cleaners or antistatic spray intended for vinyl LPs.



Note on High-Speed CD-MD Synchro-Recording

Certain CD conditions may cause sound dropout or noise in the recording results, or even create unwanted tracks on the MD. If this happens, clean the CD as instructed on "On cleaning" above, and record material to the MD using normal-speed CD-MD Synchro-Recording only.

Handling MDs

The MD is enclosed in a cartridge to protect the disc from debris or fingerprints and to make it easy to handle.

However, the presence of debris or a warped cartridge may inhibit the disc from operating properly. To ensure that you can always listen to the highest quality music, follow the precautions below:

- Do not touch the internal disc directly. Forcing the shutter open may damage the internal disc.
- Be sure to stick the labels supplied with the MD to the appropriate positions. The shape of the labels may vary depending on the MD brand.

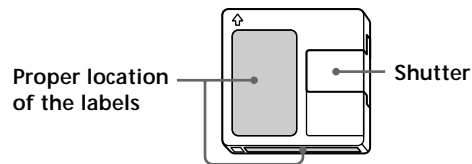

Where to keep the MDs

Do not place the cartridge where it may be exposed to direct sunlight or extremely high heat and humidity.

Regular maintenance

Wipe dust and debris from the surface of the cartridge with a dry cloth.

Sony  line

<http://www.world.sony.com/>